

HP 83206A TIA/EIA-136 Cellular Adapter

User's Guide

HP Part Number 83206-90002

Revision H

Printed in U.S.A.

October 1999

© Copyright Hewlett-Packard Company, 1998



Notice

Information contained in this document is subject to change without notice.

All Rights Reserved. Reproduction, adaptation, or translation without prior written permission is prohibited, except as allowed under the copyright laws.

This material may be reproduced by or for the U.S. Government pursuant to the Copyright License under the clause at DFARS 52.227-7013 (APR 1988).

Hewlett-Packard Company
Education Tools Department
24001 E. Mission
Liberty Lake, WA 99019-9599
U.S.A.

Manufacturer's Declaration

This statement is provided to comply with the requirements of the German Sound Emission Directive, from 18 January 1991.

This product has a sound pressure emission (at the operator position) < 70 dB(A).

- Sound Pressure $L_p < 70$ dB(A).
- At Operator Position.
- Normal Operation.
- According to ISO 7779:1988/EN 27779:1991 (Type Test).

Herstellerbescheinigung

Diese Information steht im Zusammenhang mit den Anforderungen der Maschinenlärminformationsverordnung vom 18 Januar 1991.

- Schalldruckpegel $L_p < 70$ dB(A).
- Am Arbeitsplatz.
- Normaler Betrieb.
- Nach ISO 7779:1988/EN 27779:1991 (Typprüfung).

Safety Considerations

GENERAL

This product and related documentation must be reviewed for familiarization with safety markings and instructions before operation.

This product has been designed and tested in accordance with IEC Publication 1010, "Safety Requirements for Electronic Measuring Apparatus," and has been supplied in a safe condition. This instruction documentation contains information and warnings which must be followed by the user to ensure safe operation and to maintain the product in a safe condition.

SAFETY EARTH GROUND

A uninterruptible safety earth ground must be provided from the main power source to the product input wiring terminals, power cord, or supplied power cord set.

CHASSIS GROUND TERMINAL

To prevent a potential shock hazard, always connect the rear-panel chassis ground terminal to earth ground when operating this instrument from a dc power source.

SAFETY SYMBOLS



Indicates instrument damage can occur if indicated operating limits are exceeded. Refer to the instructions in this guide.



Indicates hazardous voltages.



Indicates earth (ground) terminal

WARNING

A WARNING note denotes a hazard. It calls attention to a procedure, practice, or the like, which, if not correctly performed or adhered to, could result in personal injury. Do not proceed beyond a WARNING sign until the indicated conditions are fully understood and met.

CAUTION

A CAUTION note denotes a hazard. It calls attention to an operation procedure, practice, or the like, which, if not correctly performed or adhered to, could result in damage to or destruction of part or all of the product. Do not proceed beyond an CAUTION note until the indicated conditions are fully understood and met.

Safety Considerations for this Instrument

WARNING

This product is a Safety Class I instrument (provided with a protective earthing ground incorporated in the power cord). The mains plug shall only be inserted in a socket outlet provided with a protective earth contact. Any interruption of the protective conductor inside or outside of the product is likely to make the product dangerous. Intentional interruption is prohibited.

Whenever it is likely that the protection has been impaired, the instrument must be made inoperative and be secured against any unintended operation.

If this instrument is to be energized via an autotransformer (for voltage reduction), make sure the common terminal is connected to the earth terminal of the power source.

If this product is not used as specified, the protection provided by the equipment could be impaired. This product must be used in a normal condition (in which all means for protection are intact) only.

No operator serviceable parts in this product. Refer servicing to qualified personnel. To prevent electrical shock, do not remove covers.

Servicing instructions are for use by qualified personnel only. To avoid electrical shock, do not perform any servicing unless you are qualified to do so.

The opening of covers or removal of parts is likely to expose dangerous voltages. Disconnect the product from all voltage sources while it is being opened.

Adjustments described in the manual are performed with power supplied to the instrument while protective covers are removed. Energy available at many points may, if contacted, result in personal injury.

The power cord is connected to internal capacitors that may remain live for 5 seconds after disconnecting the plug from its power supply.

For Continued protection against fire hazard, replace the line

fuse(s) only with 250 V fuse(s) or the same current rating and type (for example, normal blow or time delay). Do not use repaired fuses or short circuited fuseholders.

CAUTION Always use the three-prong ac power cord supplied with this product. Failure to ensure adequate earth grounding by not using this cord may cause product damage.

This product is designed for use in Installation Category II and Pollution Degree 2 per IEC 1010 and IEC 664 respectively. For indoor use only.

This product has autoranging line voltage input, be sure the supply voltage is within the specified range.

Ventilation Requirements: When installing the product in a cabinet, the convection into and out of the product must not be restricted. The ambient temperature (outside the cabinet) must be less than the maximum operating temperature of the product by 4° C for every 100 watts dissipated in the cabinet. If the total power dissipated in the cabinet is greater than 800 watts, then forced convection must be used.

Product Markings

CE - the CE mark is a registered trademark of the European Community. A CE mark accompanied by a year indicated the year the design was proven.

CSA - the CSA mark is a registered trademark of the Canadian Standards Association.

Hewlett-Packard Warranty Statement for Commercial Products

HP 83206A TIA/EIA-136 Cellular Adapter

Duration of Warranty: One Year

1. HP warrants HP hardware, accessories and supplies against defects in materials and workmanship for the period specified above. If HP receives notice of such defects during the warranty period, HP will, at its option, either repair or replace products which prove to be defective. Replacement products may be either new or like-new.
2. HP warrants that HP software will not fail to execute its programming instructions, for the period specified above, due to defects in material and workmanship when properly installed and used. If HP receives notice of such defects during the warranty period, HP will replace software media which does not execute its programming instructions due to such defects.
3. HP does not warrant that the operation of HP products will be uninterrupted or error free. If HP is unable, within a reasonable time, to repair or replace any product to a condition as warranted, customer will be entitled to a refund of the purchase price upon prompt return of the product.
4. HP products may contain remanufactured parts equivalent to new in performance or may have been subject to incidental use.
5. The warranty period begins on the date of delivery or on the date of installation if installed by HP. If customer schedules or delays HP installation more than 30 days after delivery, warranty begins on the 31st day from delivery.
6. Warranty does not apply to defects resulting from (a) improper or inadequate maintenance or calibration, (b) software, interfacing, parts or supplies not supplied by HP, (c) unauthorized modification or misuse, (d) operation outside of the published environmental specifications for the product, or (e) improper site preparation or maintenance.
7. TO THE EXTENT ALLOWED BY LOCAL LAW, THE ABOVE WARRANTIES ARE EXCLUSIVE AND NO OTHER WARRANTY OR CONDITION, WHETHER WRITTEN OR ORAL IS EXPRESSED OR IMPLIED AND HP SPECIFICALLY DISCLAIMS ANY IMPLIED WARRANTIES OR CONDITIONS OR MERCHANTABILITY, SATISFACTORY QUALITY, AND FITNESS FOR A PARTICULAR PURPOSE.

8. HP will be liable for damage to tangible property per incident up to the greater of \$300,000 or the actual amount paid for the product that is the subject of the claim, and for damages for bodily injury or death, to the extent that all such damages are determined by a court of competent jurisdiction to have been directly caused by a defective HP product.
9. TO THE EXTENT ALLOWED BY LOCAL LAW, THE REMEDIES IN THIS WARRANTY STATEMENT ARE CUSTOMER'S SOLE AND EXCLUSIVE REMEDIES. EXCEPT AS INDICATED ABOVE, IN NO EVENT WILL HP OR ITS SUPPLIERS BE LIABLE FOR LOSS OF DATA OR FOR DIRECT, SPECIAL, INCIDENTAL, CONSEQUENTIAL (INCLUDING LOST PROFIT OR DATA), OR OTHER DAMAGE, WHETHER BASED IN CONTRACT, TORT, OR OTHERWISE.

FOR CONSUMER TRANSACTIONS IN AUSTRALIA AND NEW ZEALAND: THE WARRANTY TERMS CONTAINED IN THIS STATEMENT, EXCEPT TO THE EXTENT LAWFULLY PERMITTED, DO NOT EXCLUDE RESTRICT OR MODIFY AND ARE IN ADDITION TO THE MANDATORY STATUTORY RIGHTS APPLICABLE TO THE SALE OF THIS PRODUCT TO YOU.

DECLARATION OF CONFORMITY

according to ISO/IEC Guide 22 and EN 45014

Manufacturer's Name: **Hewlett-Packard Co.**
Manufacturer's Address: **Spokane Division
24001 E. Mission Avenue
Liberty Lake, Washington 99019-9599
USA**

declares that the product

Product Name: TIA/EIA-136 Cellular Adapter
Model Number: HP 83206A
Product Options: This declaration covers all options of the above product.

conforms to the following Product specifications:

Safety: IEC 1010-1:1990+A1 / EN 61010-1:1993
CAN/CSA-C22.2 No. 1010.1-92

EMC: CISPR 11:1990/EN 55011:1991 Group 1, Class A
IEC 801-2:1984/EN 50082-1:1992 4 kV CD, 8 kV AD
IEC 801-3:1984/EN 50082-1:1992 3V/m
IEC 801-4:1988/EN 50082-1:1992 0.5 kV Sig. Lines, 1 kV Power Lines

Supplementary Information:

This product herewith complies with the requirements of the Low Voltage Directive 73/23/EEC and the EMC Directive 89/336/EEC.

Spokane, Washington USA November 20, 1995
Date

Vince Roland/Quality Manager

European Contact: Your local Hewlett-Packard Sales and Service Office or Hewlett-Packard GmbH
Department ZQ/Standards Europe, Herrenberger Strasse 130, D-71034 Böblingen, Germany (FAX+49-7031-14-3143)

Regional Sales and Service Offices

<p>Eastern USA Sales Office Hewlett-Packard Company 2101 Gather Rd. Rockville, MD 20850 Tel: (301) 258-2000</p>	<p>Eastern USA Sales Office Hewlett-Packard Company 2101 Gather Rd. Rockville, MD 20850 Tel: (301) 258-2000</p>	<p>Midwestern USA Sales and Service Hewlett-Packard Company 5201 Tollview Drive Rolling Meadows, IL 60008 Tel: (708) 342-2000</p>
<p>Southern USA Sales and Service Hewlett-Packard Company 1995 North Park Place Atlanta, GA 30339 Sales Tel: (404) 955-1500 Fax: (404) 980-7292 Service Tel: (404) 850-2544 Fax: (404) 980-7292</p>	<p>Southern USA Service Center Hewlett-Packard Company 930 E. Campbell Road Richardson, TX 75081 Tel: (214) 699-4331</p>	<p>Western USA Service Center Hewlett-Packard Company 301 E. Evelyn Avenue Mountain View, CA 94041 Tel: (415) 694-2000 Fax: (415) 694-0601</p>
<p>Western USA Sales and Service Hewlett-Packard Company 24 Inverness Place East Englewood, CO 80112 Sales Tel: (303) 649-5000 Fax: (303) 649-5787 Service Tel: (303) 649-5512 Fax: (303) 649-5787</p>	<p>Western USA Sales and Service Hewlett-Packard Company 1421 South Manhattan Avenue Fullerton, CA 92631 Sales Tel: (714) 999-6700 Fax: (714) 778-3033 Service Tel: (714) 758-5490 Fax: (714) 778-3033</p>	<p>United States of America Customer Information Center Hewlett-Packard Company Tel: (800) 752-0900 6:00 am to 5:00 pm Pacific Time Parts Direct: 1-800-227-8164</p>
<p>South Eastern Europe Sales and Service Hewlett-Packard Ges. m.b.h. Liebigasse 1 P.O. Box 72 A-1222 Vienna, Austria Telephone: 43 222 2500 0 Telex: 13 4425</p>	<p>European Multicountry Region Sales and Service Hewlett-Packard S.A. P.O. Box 95 150, Route dv Nant_dl_AVRIL CH-1217 Meyrin 2 Geneva, Switzerland Telephone: (41/22) 780-8111 Fax: (41/22) 780-8542</p>	<p>Northern Europe Sales and Service Hewlett-Packard Nederland B.V. Startbaan 16 1187 XR Amstelveen, The Netherlands P.O. Box 667 Telephone: 31/20 5476911 X 6631 Fax: 31-20-6471825NL</p>

<p>Asia Sales and Service Hewlett-Packard Asia Ltd. 22-30/F Peregrine Tower Lippo Center 89 Queensway, Central Hong Kong G.P.O. Box 863 Hong Kong Telephone: 852-848-7777 Fax: 852-868-4997</p>	<p>Japan Hewlett-Packard Japan, Ltd. Measurement Assistance Center 9-1, Takakura-Cho Hachioji-Shi Tokyo 192-8510, Japan Telephone: (81)-426-56-7832 Fax (81)-426-56-7840</p>	<p>International Sales Branch Headquarters Sales and Service Hewlett-Packard S.A. 39 Rue Veyrot P.O. Box 365 1217 Meyrin 1 Geneva, Switzerland Telephone: 41-22-780-4111 Fax: 41-22-780-4770</p>
<p>Australia, New Zealand Sales and Service Hewlett-Packard Ltd. P.O. Box 221 31-41 Joseph Street Blackburn, Victoria 3130 Telephone: (61/3) 895-2895 Fax: (61/3) 898-9257</p>	<p>Canada Sales and Service Hewlett-Packard (Canada) Ltd. 5150 Spectrum Way Mississauga, Ontario L4W 5G1 Canada Telephone: (416) 206-4725 Fax: (416) 206-4739</p>	<p>Canada Service Center Hewlett-Packard Company 17500 Transcanada Highway S. Serv Road Kirkland, Quebec H9J 2X8 Canada Telephone: (416) 206-3295</p>
<p>Canada Service Center Hewlett-Packard Ltd. 11120 178 Street Edmonton, Alberta T5S 1P2 Canada Telephone: (403) 486-6666 Fax: (403) 489-8764</p>	<p>Latin America Hewlett-Packard Company LAHQ Mexico City Col. Lomas de Virreyes 11000 Mexico D.F. Mexico Telephone: (52/5) 326-4000 Fax: (52/5) 202 7718</p>	<p>United Kingdom Sales and Service Hewlett-Packard Ltd. Cain Road Amen Corner Bracknell, Berkshire RG12 1HN United Kingdom Telephone: 44 344 360000</p>

Contents

1 Getting Started

About the Cellular Adapter 32

Get ready to test 33

Described In this Chapter 33

Connecting the Cellular Adapter to the Test Set 34

Getting the Test Set to a Known State 34

Selecting the Proper Notch Filter for Audio Measurements 34

Zeroing the Average Power Meter 35

Going to the

TIA/EIA-136 CALL CONTROL Screen 37

Connecting a Mobile 38

Testing mobiles 40

About the PCS Interface 42

Firmware Revision Needed for PCS Testing 42

Installing the PCS Interface 43

Using the PCS Interface 44

Contents

2 Product Description

Purpose of this Cellular Adapter 50

The DCCH Call Processing Screens 51

CALL CONTROL Screen 53

CALL CONFIGURE Screen 54

DIGITAL

MEASUREMENT Screen 55

ANALOG MEASUREMENT Screen 56

Tasks You Can Perform with the Cellular Adapter 57

Call Processing Tasks 57

Measurements and Data available 58

Use the HP 8920 to Make Other Measurements 59

Contents

3 Processing Calls

About Call Processing Tasks and Measurements 62

PCS measurements 63

Configure the Test Set to Emulate a Base Station 64

How to know when the call is dropped 68

Call Processing Procedures 69

Authentication 70

Initialize Call Processing with Authentication 72

Page a Mobile Station with Authentication 74

Originate a Call with Authentication 74

Perform an SSD Update 75

Perform a Unique Challenge 77

Caller ID 79

Country Code 80

Downbanding 81

FACCH SACCH Programming 82

Handoff 83

Choosing the proper combination of DVCC, slot, and channel number 84

MAHO 86

Message Waiting Indicator 87

Orders 88

Origination 89

Choosing the proper combination of DVCC, slot, and channel number 90

Page 91

Contents

Choosing the proper combination of DVCC, slot, and channel number 92

Registration 93

Release by Mobile 95

Release by Test Set 96

Short Message Services 97

To Send a Short Message to the Mobile 97

Contents

4 Making Measurements

How to Read Data and Make Measurements 100

The Difference Between Data and Measurements 100

How to Switch Between Data and Meas Mode 101

Data Displayed 101

Connect State & Mobile Test Mode 102

Making changes to the Measurements display 107

How to determine if a call is dropped 111

Adjacent Channel Power 112

Analog Parameters 113

Average Power 114

BER 115

How the Test Set measures raw BER 116

Digital Measurement Screen Tests 118

Droop 120

EVM 121

Frequency Error 122

Magnitude Error 123

MAHO 124

Origin Offset 128

Phase Error 129

Power Measurements 130

Power Measurements Descriptions 131

Sync Location 138

Contents

TX Power 139

Measuring Absolute TX Power on an AVC 140

Measuring Relative TX Power on a DTC 141

Measuring Average Power on an AVC or DTC with the PCS Interface 142

WER (DTC or DCCH) 143

How the Test Set measures WER 144

Contents

5 Programming the Cellular Adapter

Programming the Cellular Adapter 148

Programming in the Call Processing Subsystem 148

Program Example 149

Displaying the DCCH screens 154

Status Registers for DCCH Call Processing 155

Triggering and Remote to Local mode transitions 158

FACCH and SACCH programming 159

FACCH and SACCH description 159

Programming commands for FACCH and SACCH 159

6 HP-IB Syntax Diagrams

Overview 170

Diagram Conventions 171

DCCH 172

RF Path Control 192

Meas 193

SERV 198

Querying the Timebase

Out-of-Lock Indicator 198

Checking if Temperature Compensation is Necessary 198

Integer Number Setting Syntax 199

Real Number Setting Syntax 200

Multiple Real Number Setting Syntax 201

Number Measurement Syntax 202

Multiple Number Measurement Syntax 204

Contents

7 Screen and Field Descriptions

The DCCH Call Processing Screens 206

DAMPS Call Processing 206

Parameters of the CALL CONTROL Screen 208

Parameter name 208

The CALL CONTROL screen 208

Access 209

Active 209

Amplitude 210

Band 210

CC Order 210

Chan 210

Connect 210

Cntl Order 211

Cntrl Channel 211

Display 212

DVCC 212

Handoff 213

MS ID 214

Order 215

Page 215

Pwr Lvl 216

Register 216

Release 217

SAT 217

SID 217

Slot 218

System Type 218

Traffic Channel Assignment 218

Type 218

VC Order 219

Voc 219

Voice Channel Assignment 219

Parameters of the DCCH CALL CONFIGURE Screen 220

Neighbors 220

Contents

# Systems	221
% BIT ERROR	221
Access Burst	221
BAND (Neighbor List)	221
Channel (Neighbor List)	221
Country Code	221
DCCH DVCC	222
Dig Signal	222
DTC Burst	222
Power Meter	222
PSID/RSID	222
Public Sys	223
RF Path	223
Reg Conf	223
Sat Tol	224
SMS Contents	224
SMS Msg	224
SMS Size	224
SMS Type	225
SOC	225

Parameters of the DCCH CALL CONFIGURE II Screen 226

Calling Name	226
Calling Num	226
MS Capab	227
Name Size	227
Num Fax	227
Num SMS	227
Num Voice	227
Pres Type	228
Screen Ind	228
Temperature	228

Parameters of the DIGITAL MEASUREMENT Screen 229

The DIGITAL MEASUREMENT Screen	229
Amplitude	230
Dig Meas	230
DVCC	230

Contents

Pwr Gain 230
Slot 231
Traffic Chan 231
Trig Type 232

Parameters of the ANALOG MEASUREMENT Screen 233

The ANALOG MEASUREMENT Screen 233
AF Anl In 233
AF Freq 234
AFGen1 Freq 234
AFGen1 To 234
Amplitude 234
De-Emphasis 234
Detector 235
Filter 1 235
Filter 2 235
FM Deviation 235
TX Freq Error 235
TX Power 235

Parameters of the DTC AUTHENTICATION Screen 236

A_KEY 237
Authent 237
CHECKSUM 237
ESN 237
RAND 238
RANDSSD 238
RAND_U 238

Parameters of the AVC AUTHENTICATION Screen 239

A_Key 240
Authent 240
ESN 240
RAND_A 241
RAND_B 241
RANDSSD_1 241
RANDSSD_2 241
RANDSSD_3 242

Contents

RAND_U 242
1 of N 242

Contents

8 Connector Descriptions

Connector overview 244

Front Panel Connectors 245

Analyzer Baseband Data In 245

Analyzer Data Clock In 245

Analyzer Trigger In 246

Generator Baseband Data In 246

Rear Panel Connectors 247

Anl Trig Out 247

Bit Clk Out 247

Control I/O 247

CW RF In 248

Diag Out 248

Ext IF In 248

Frame Clk Out 249

Gen BB Data Out 249

Ref In 249

Serial Port 250

Symbol Clk Out 250

114.3 MHz IF In 250

10 MHz REF OUT 251

IQ RF OUT 252

9 Troubleshooting

General Operating Reminders 254

254

Remote Operation Considerations and Recommendations 257

Loopback BER 257

To Prevent Problems When Changing the System Type 257

Temperature Compensation 257

Handoffs 257

Releasing a Call 257

Going from the Data Display to the Measurement Display Mode 257

Changing from ANALOG MEAS Screen to CALL CONTROL Screen Measurements 258

Zeroing the Power Meter With a PCS Interface 258

Triggering to Prevent Non-recoverable Firmware Errors 258

Reducing Wait Statements in Your Program 258

Problems With or Without a PCS Interface Present 259

Mobile will not camp on a Control Channel. 259

Message “DTC msg not acknowledged by mobile” occurs during attempt to page mobile. 259

Mobile successfully answers page but immediately drops the call. 259

The message “Squelch Interrupt Overfull. Press MEAS RESET” is displayed. 259

The message “Symbol clock is weak: accuracy is degraded” is displayed. 260

Problems Specific to Using a PCS Interface 261

Mobile will not camp on a Control Channel. 261

Message “Selection not supported in PCS mode” occurs. 261

The PCS Interface is on but the PCS Mode field does not appear on the CONFIGURE screen. 261

Messages 262

Contents

10 TIA/EIA-136 Basics

What is TIA/EIA-136? 266

Basic Features of TIA/EIA-136 267

TIA/EIA-136 transceiver 268

The Transceiver Control Block 268

Modulation Methods 268

The Control Channels 268

TIA/EIA-136 Transceiver Block Diagram 270

Basic Functions of the DCCH in TIA/EIA-136 271

Power On and Initialization 271

DCCH Initialization Tasks 272

Call Origination 273

Call Release 276

Time Alignment and Other Orders 276

Registration and Periodic Registration 276

Paging 278

Handoffs and Mobile Assisted Handoff (MAHO) 279

Short Message Service (SMS) 280

Authentication 281

Non-public System Selection 282

Mobile Assisted Channel Allocation(MACA) 283

Dual Tone Multi-Frequency Signaling (DTMF) 283

11 Installing the Cellular Adapter

Connecting the Cellular Adapter to the HP 8920 Series Test Set 286

I/Q Modulator and Relative TX Power Calibration 287

PCS Interface Connections 288

Connecting a Printer to the Serial Port 289

Contents

Glossary 291

Contents

Index 299

Getting Started

This chapter introduces you to the HP 83206A TIA/EIA-136 Test System and will show you how to prepare the Test System to test a mobile transceiver. Use of the HP 83236B PCS Interface is also discussed.

This manual is written for those who are already familiar with the HP 8920B RF Communications Test Set. If you want to learn more about using the Test Set itself, refer to the *HP 8920B User's Guide*.

About the Cellular Adapter

This Cellular Adapter is a test set adapter for the HP 8920B RF Communications Test Set. It works with the Test Set to test mobile transceivers built according to the TIA/EIA-136 standard. The Test Set and the Cellular Adapter are collectively referred to as the Test System.

TIA/EIA-136 is a standard which describes a Time Division Multiple Access (TDMA) cellular communications system. The major feature which distinguishes TIA/EIA-136 from its predecessor TIA/EIA-627 is the addition of a Digital Control Channel (DCCH). To learn more about TIA/EIA-136, refer to the TIA/EIA standard, or read [Chapter 10, “TIA/EIA-136 Basics,”](#) on page 265.

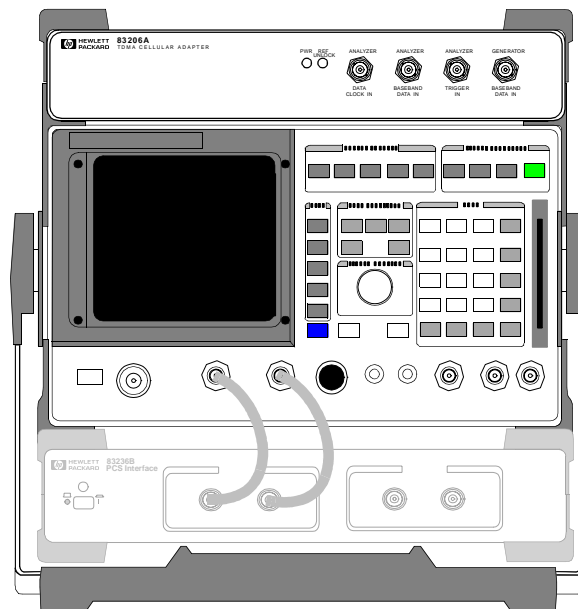
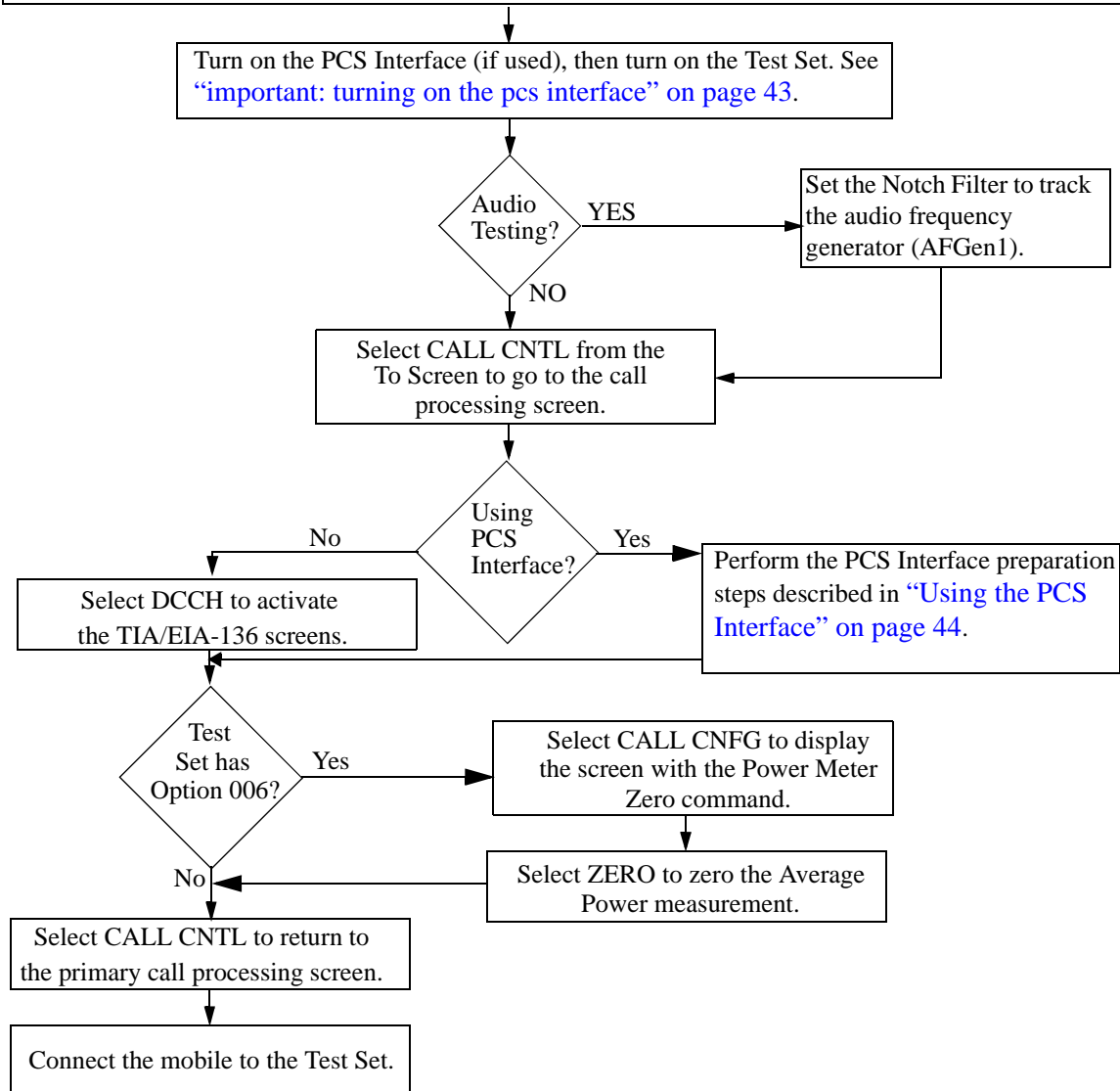

Figure 1 The Cellular Adapter Attached to a Test Set (shown with the optional PCS Interface)

Get ready to test

Described In this Chapter Refer to the following flowchart to see the steps necessary to get the Test System ready to test a mobile.

Make sure the Cellular Adapter, and PCS Interface (if used), and the Test Set are properly connected. If the PCS Interface is used, the HP 83236B System Connectivity test must be successfully completed before proceeding.



Connecting the Cellular Adapter to the Test Set

If you purchased the Test Set with the Cellular Adapter (Test Set Option 800 or 801), they probably arrived completely assembled. If you need instructions to make the connections between the Test Set and the Cellular Adapter, refer to Chapter 11, “Installing the Cellular Adapter,” on page 285.

Getting the Test Set to a Known State

If your Test Set is already on, press PRESET to put it in a known state. If your Test Set’s power is turned off, press POWER to start the Test Set. If a PCS interface is connected, turn on the PCS interface before turning on the Test Set.

Selecting the Proper Notch Filter for Audio Measurements

If you want to make audio measurements while testing TIA/EIA-136 mobiles, you must set the audio frequency notch filter to track AF Generator 1. If you do not want to make audio measurements, proceed to “Zeroing the Average Power Meter” on page 35.

How to set the audio frequency notch filter to track AF Generator 1

1. Press and release the blue SHIFT key and then the DUPLEX key to display the CONFIGURE screen.
2. Position the cursor on the **Notch Coupl** field and select **AFGen1**.

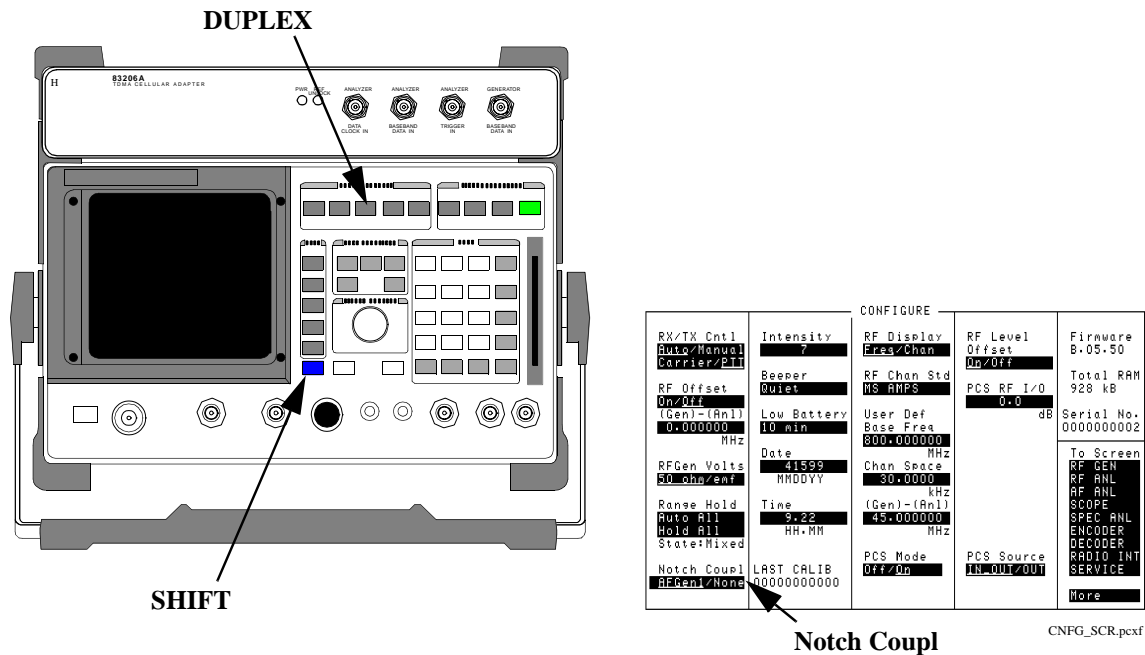

Figure 2 Presetting the Test System and Selecting the AFGen1 Notch Filter Selection

Zeroing the Average Power Meter

TDMA Average Power can be measured if your Test Set is equipped with Option 006, or if you have a PCS Interface connected. If you are not using the PCS Interface, you need to zero the average power detector in the Test Set first using the following procedure.

See “Average Power” on page 114 and “Power Measurements” on page 130 for more information.

1. Disconnect all cables from the RF IN/OUT port of the Test Set.
2. Select **CALL CNTL** from the **To Screen**. (Use **MORE** to display the field **CALL CNTL**.)
3. Select **DCCH** in the **System Type** field.
4. Select **CALL CNFG** from the **To Screen**.
5. Select **Zero** from the **Power Meter** field. This zeros the power for the Test System. When the Test Set is finished zeroing, the **Zero** field is no longer highlighted.
6. Select **CALL CNTL** from the **To Screen**. This returns the Test Set to the primary call processing screen.

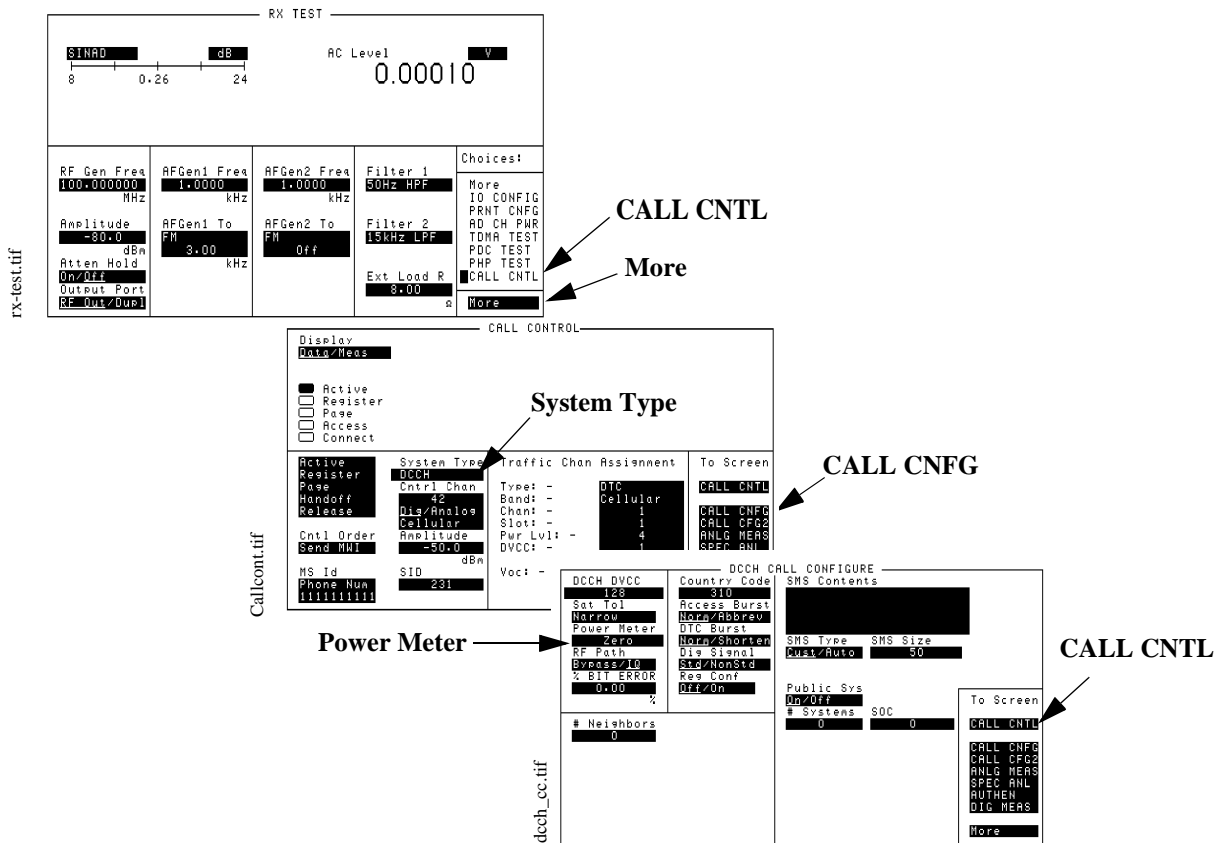

Figure 3 Zeroing the Average Power Meter

***HOW OFTEN
SHOULD YOU ZERO
THE AVERAGE
POWER METER?***

A frequently zeroed Test System will ensure the highest measurement accuracy.

The Zero Power function measures the input power with no cables connected to the Test System. The input power is measured for all gain settings. These measurements are stored in static RAM, and the Test System uses them to calculate any offsets when measuring power with a DUT attached. The values are updated whenever you zero the power meter, and the latest values are stored for the life of the static RAM backup battery.

You should zero power frequently if the Test System is still warming up, about two to three times within the first two hours. You should zero power occasionally even if the Test System is on continuously. (Occasionally can mean daily, weekly or monthly, as you choose).

Zeroing TX Power

TX Power and Average Power are different measurements. TX Power is zeroed by running a ROM program in the Test Set when the Cellular Adapter is attached. See [“TX Power” on page 139](#) for a description of the TX Power measurement.

Going to the TIA/EIA-136 CALL CONTROL Screen

In order to begin testing TIA/EIA-136 mobiles, the Test System must be at the CALL CONTROL screen. In this screen, you can select the TIA/EIA-136 system, control basic call processing functions, and make measurements.

How to access the TIA/EIA-136 CALL CONTROL screen

1. Make sure you have already done the following:
 - Zeroed the RF Power meter
 - Selected the proper audio filter, if you will test audio
2. Select **CALL CNTL** from the **To Screen**. The CALL CONTROL screen will be displayed.
3. Select **DCCH** from the **System Type** field. Now the CALL CONTROL screen shows the parameters necessary to test the digital portion of TIA/EIA-136 mobiles.

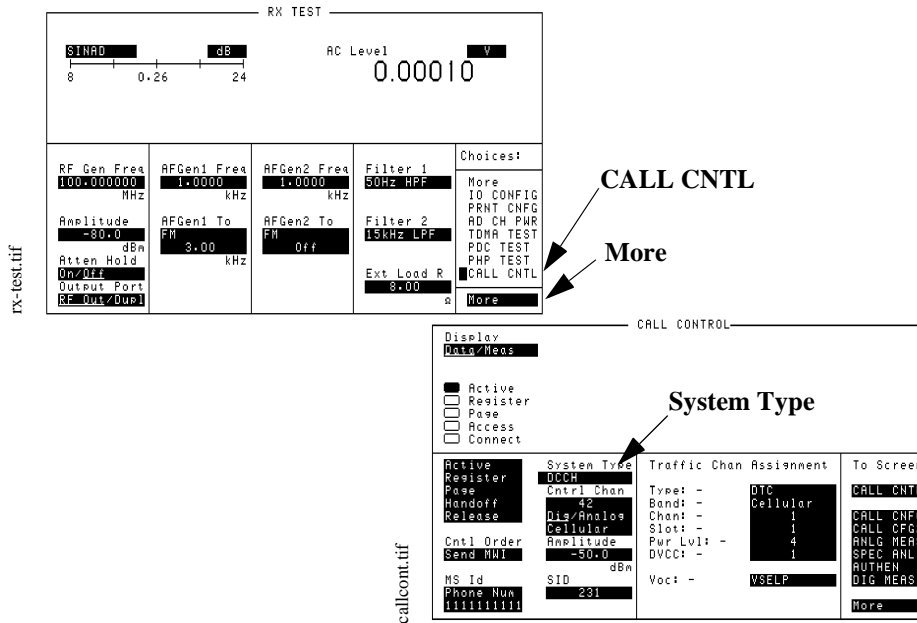

Figure 4 How to Access the DCCH CALL CONTROL Screen

Connecting a Mobile

A single RF connection is used to test the RF performance of a mobile. If you are not using a PCS Interface, you connect the antenna port of the mobile to the RF IN/OUT port of the Test Set. If you are using a PCS Interface, you connect the antenna port of the mobile to the RF IN/OUT port of the PCS Interface. Audio test connections are the same in all cases.

Most manufacturers have specific connectors which can connect the audio and the RF signal to the Test Set. [Figure 5 on page 1 38](#) shows how to connect a mobile to a Test System without using a PCS Interface. [Figure 6 on page 1 39](#) shows how to connect a mobile to a Test System that includes the PCS Interface.

Rear-panel connections for the Cellular Adapter and PCS Interface are in [Chapter 11, “Installing the Cellular Adapter,” on page 285](#).

**DO NOT CONNECT
TO THE ANT IN PORT
ON THE FRONT
PANEL**

Do not connect the antenna of the mobile to the ANT IN port on the front panel of the Test Set. This will cause the overpower protection circuitry to activate when the mobile is transmitting. Refer to the *HP 8920 RF Communications Test Set User’s Guide* for more information.

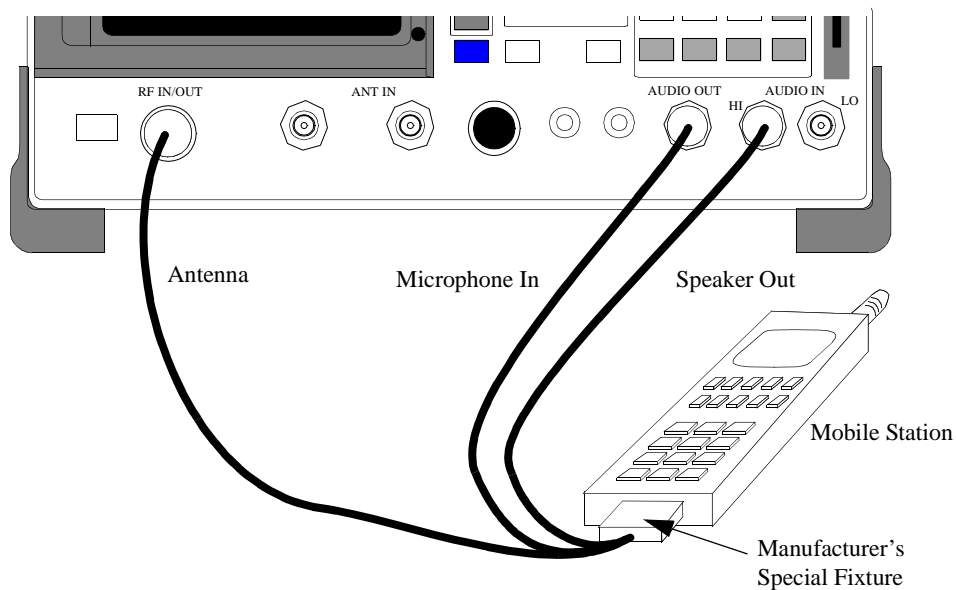

Figure 5

Connecting a Mobile to the Test Set Without the PCS Interface

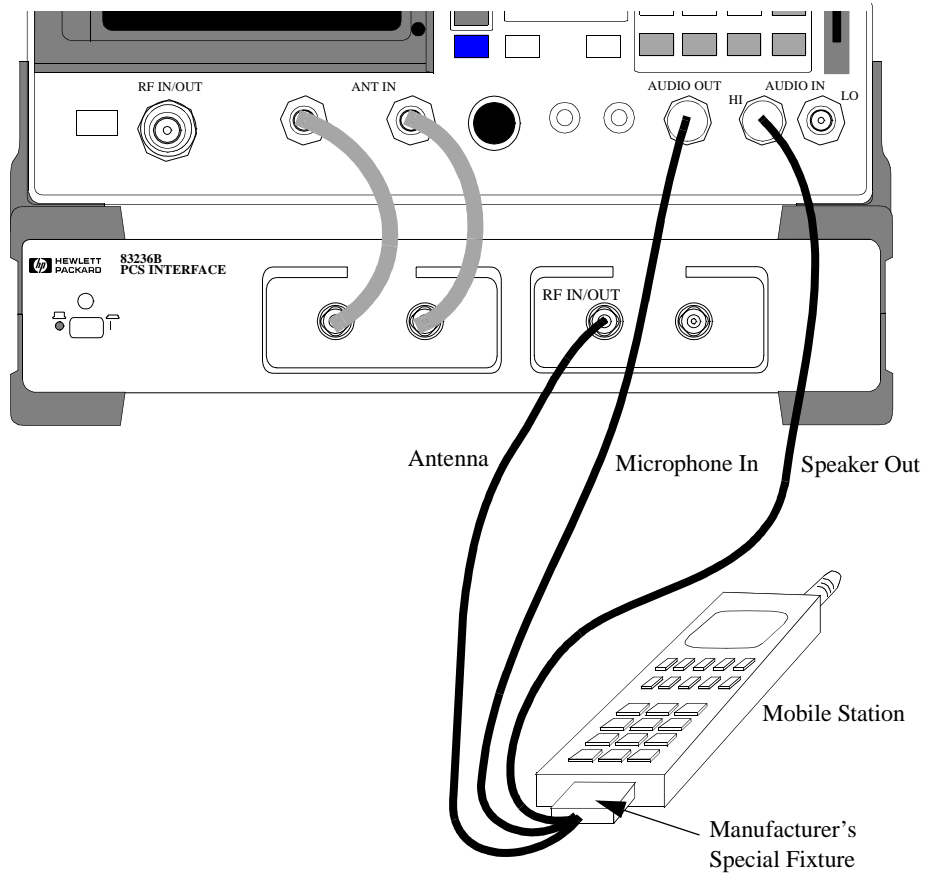

Figure 6

Connecting a Mobile to the Test Set With the PCS Interface

Testing mobiles Use the following flowchart to plan your test method.

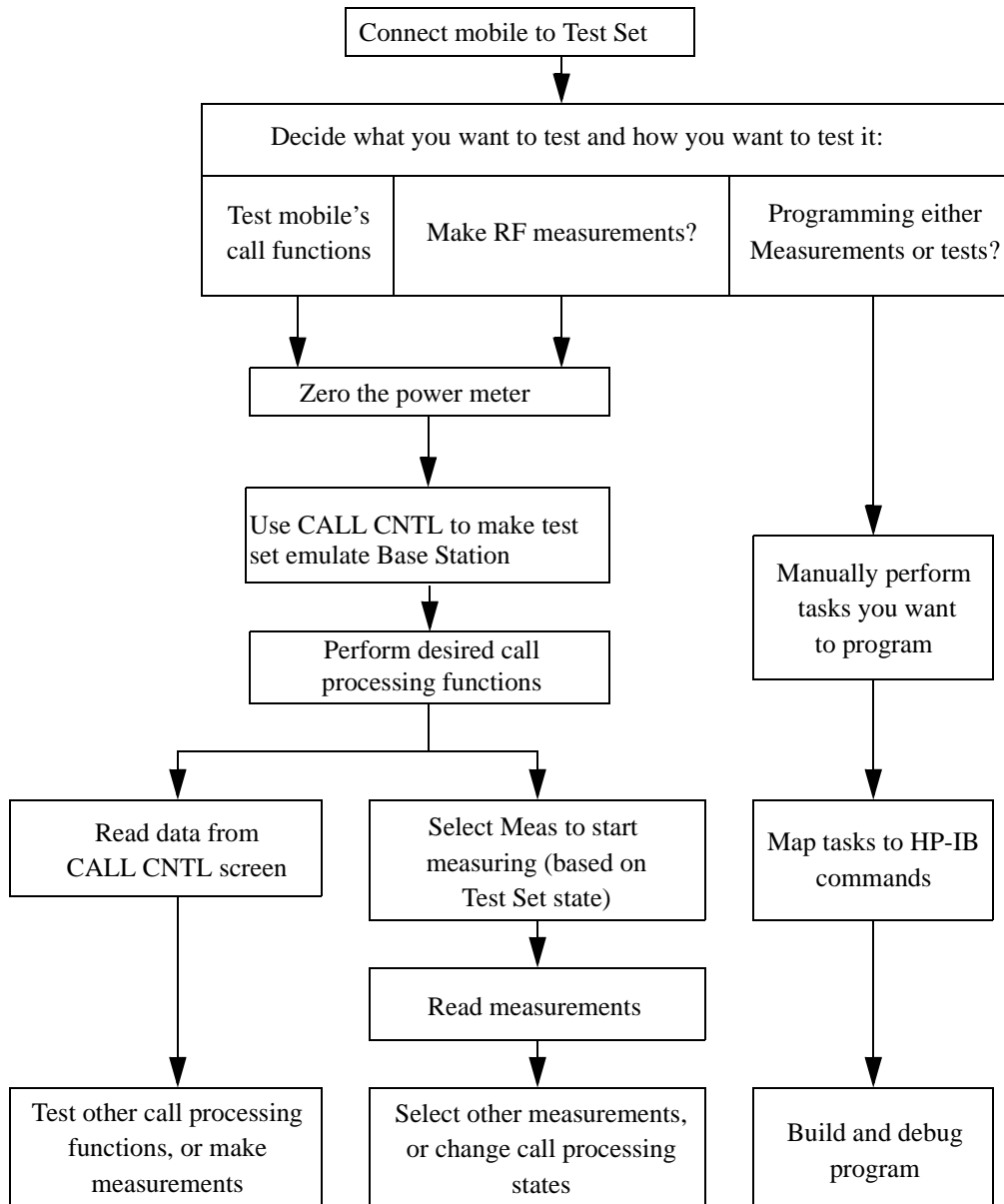

Figure 7 Overview of Tasks to Test a Mobile

Proceed to [Chapter 2, “Product Description,”](#) on page 49, to learn more about the Test System’s features and operation. Go to [Chapter 3, “Processing Calls,”](#) on page 61, to learn about call processing, to [Chapter 4, “Making Measurements,”](#) on page 99 to learn about measurements

About the PCS Interface

The HP 83236B PCS Interface can be used with the Test Set and Cellular Adapter to test TDMA mobiles in the cellular band (800 MHz to 900 MHz) and those operating in the North American PCS band (1850 MHz to 1990 MHz). The interface serves as the frequency up/down converter for the Test Set for PCS testing.

Firmware Revision Needed for PCS Testing

PCS testing requires specific Test Set and Cellular Adapter firmware.

The Test Set's firmware is upgraded using a single memory card. The Cellular Adapter's firmware is upgraded using two memory cards.

Test Set Firmware Requirement

- Revision B.05.00 or higher. Check the revision number by pressing **SHIFT, DUPLEX (CONFIG)** to access the **CONFIGURE** screen and reading the **Firmware** number in the upper right corner.

Cellular Adapter Firmware Requirements

- DSP revision 970501 or higher; Protocol revision 970730 or higher. These revisions are checked using the following procedure:
 1. Press **SHIFT, DUPLEX (CONFIG)** to access the **CONFIGURE** screen.
 2. Select **SERVICE** from the **To Screen** menu. This is the only way to access the **SERVICE** screen.
 3. Select the **Latch** field on the **SERVICE** screen.
 4. From the displayed list of latches, select the latch that corresponds to the firmware version you want to verify.
 - Select **rx_dsp_revision** for the receive DSP firmware revision.
 - Select **protocol_fw_revesion** for the Protocol firmware revision.
 5. Read the revision number in the **Value** field.

To Order a Firmware Upgrade

You can upgrade your firmware to the latest version available by ordering HP 83206A Option R58. Contact your local HP Field Sales Engineer for ordering assistance and information.

Installing the PCS Interface

The PCS Interface is connected by a serial cable to the Test Set. Interface control is provided by the Test Set's internal IBASIC controller. The timebase reference for the PCS Interface (and Cellular Adapter) comes from the Test Set. No Frame Clock connection is needed.

System Connectivity software is used to verify operation after connecting the PCS Interface to the Test System. The software is run from the PCMCIA card shipped with the PCS interface. Be sure to set the HP-IB/Serial switch on the PCS Interface to the **ser** position before turning the PCS Interface on and running the test. During the test, you are asked to select serial or HP-IB control of the interface. Select Serial Control and follow the remaining instructions displayed on the Test Set's screen.

Instructions for connecting the PCS Interface and running the connectivity software are provided in the *HP 83236B PCS Interface Operating Manual* shipped with the interface. Connections to the interface are provided in "[PCS Interface Connections](#)" on page 288.

***IMPORTANT:
TURNING ON THE
PCS INTERFACE***

In order for the Test Set to detect the connected PCS Interface, the PCS Interface must already be turned on while the Test Set is powering up.

Using the PCS Interface

After installing the PCS Interface and successfully running the System Connectivity test software, you need to perform some additional operations to properly use the interface. These operations include:

1. Initializing the PCS Interface for operation with the Test System.
2. Entering path losses into the PCS Interface.
3. Specifying the type of mobile you are testing.
4. Compensating for temperature changes.
5. Selecting the correct vocoder.

Initializing the PCS Interface

This must be done every time you turn the instruments on, even if you are not testing PCS mobiles.

The **PCS Mode** field on the CONFIGURE screen initializes the PCS Interface and tells the Test Set to alter its frequency and power settings accordingly. The CONFIGURE screen is accessed by pressing SHIFT, DUPLEX (CONFIGURE). See [Figure 8 on page 1 45](#)

DO NOT USE AUTO-TUNING WITH THE PCS INTERFACE

When the **PCS Mode** is set to On, the RF Analyzer's **Tune Mode** field is automatically set to Manual. You should not change this setting back to Auto while using the PCS Interface because the automatic tuning function may not properly tune to the down-converted signal from the interface.

Entering Path Losses to the PCS Interface's RF IN/OUT port.

Losses from cables and connectors between the mobile being tested and the PCS Interface's RF IN/OUT port need to be accounted for. The loss value is entered in the **PCS RF I/O** field on the CONFIGURE screen. Setting the **RF Level Offset** field to **On** allows this value to affect Test Set operation. This causes the levels in and out of the interface to be compensated for, increasing measurement accuracy. See [Figure 8 on page 1 45](#).

These fields allow you to enter and enable or disable compensation for any path loss between the mobile and the PCS Interface's RF IN/OUT port.

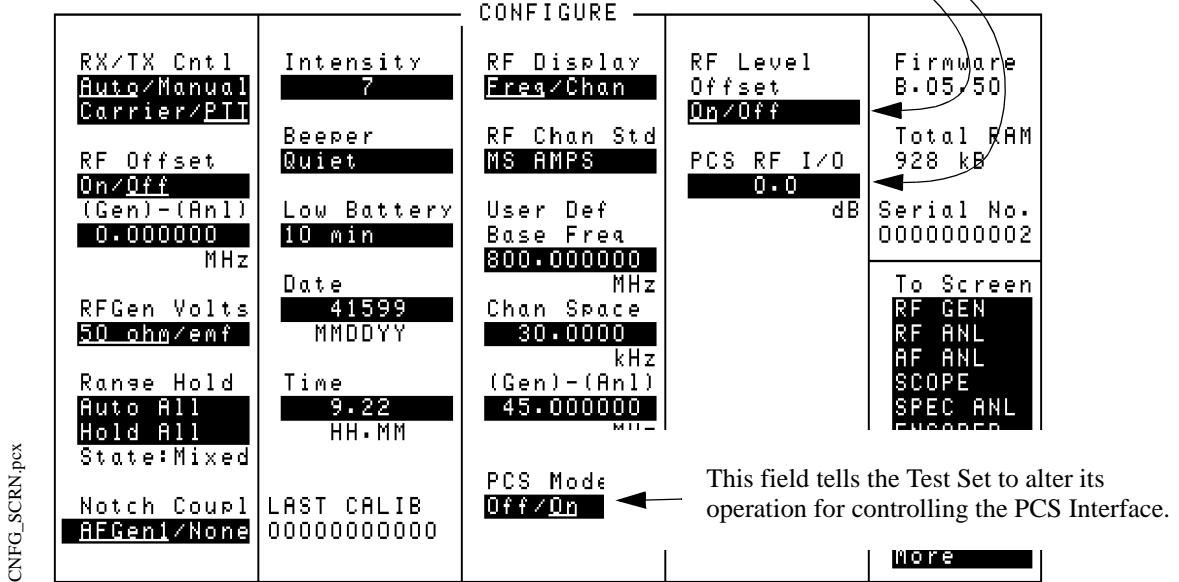

Figure 8 Setting the PCS Mode control and entering PCS Interface path losses.

Selecting RF OUT Only as the RF Output Port

When the PCS mode is selected, the RF output of the PCS Interface can be directed to the RF OUT Only port on the PCS Interface. (The RF *input* to the PCS Interface always goes to the RF IN/OUT port.)

To select the RF OUT Only port as the RF output:

1. Access the CONFIGURE screen.
2. Set the **PCS Mode** field to On.
3. Set the **PCS Source** field to OUT.

When OUT is selected, the **RF Level Offset** field's setting is not applied to the output level.

CNFG_SCRN.pcx

Specifying the Type of Mobile Station You Are Testing:

Even though you may be operating a PCS-compatible phone in the cellular band, it still uses the PCS protocol to perform call processing. You can also test non-PCS phones through the PCS Interface, so you still need to tell the test set what type of mobile you are testing. This is done using the **MS Capab** field on the DCCH CALL CONFIGURE II screen. See [Figure 9](#).

To specify the type of mobile you are testing:

1. Access the CALL CONTROL screen by highlighting the **More** field and selecting **CALL CNTL** from the list of choices.
2. Set the **System Type** to **DCCH**.
3. Select **CALL CFG2** from the **To Screen** list.
4. Set the **MS Capab** field to indicate the type of mobile you are testing.
 - Select **US PCS** when testing PCS-capable mobiles (whether they are being tested in the PCS band or not).
 - Select **Cellular** when testing standard cellular band TIA/EIA-136 mobiles.

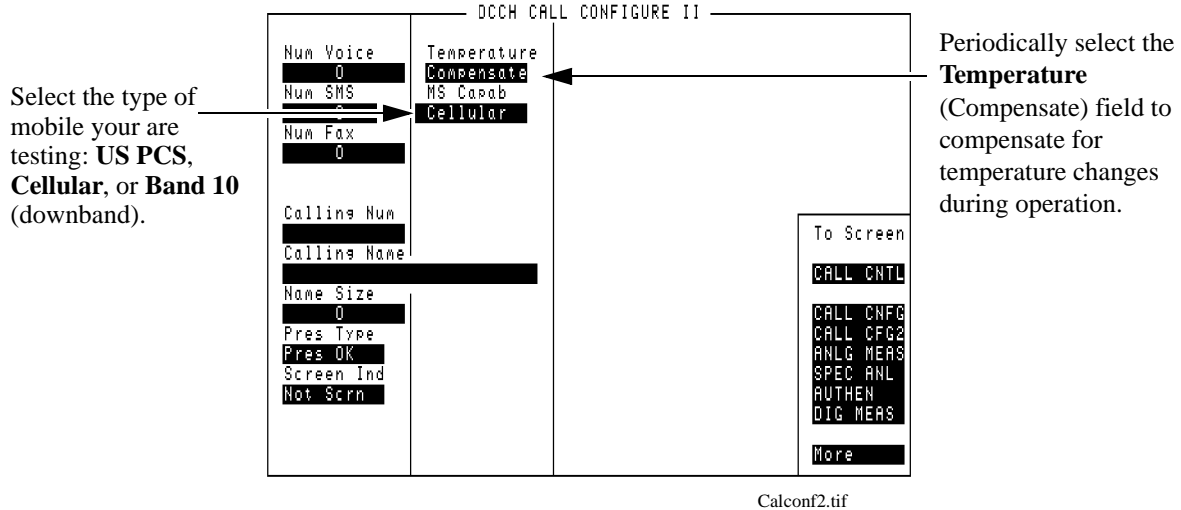

Figure 9 Setting MS Capability and selecting Temperature Compensation.

Compensating for Temperature Changes

Temperature changes during operation can affect PCS Interface operation. The degree of internal temperature change depends mostly on the environment the test system is exposed to; such as whether or not it is mounted in an enclosed rack of test equipment or is free-standing with better air circulation. If the temperature drifts more than 1°C from the last compensation, the temperature compensation operation will recalibrate to obtain the best power measurement accuracy.

As a general guideline, you should compensate for temperature changes when the PCS Interface is first turned on, and again after running for 30 to 60 minutes. This is done using the **Temperature** field on the DCCH CALL CONFIGURE II screen. See [Figure 9 on page 146](#).

To compensate for temperature changes:

1. Access the CALL CONTROL screen by highlighting the **More** field and selecting **CALL CNTL** from the list of choices.
2. Set the **System Type** to **DCCH**.
3. Select **CALL CFG2** from the **To Screen** list.
4. Select the **Temperature** field to begin the compensation process. This field will stay highlighted while compensation is performed.

For automated testing, an IBASIC command is available that can be used to query the necessity for temperature compensation. This function monitors temperature changes in the instrument over time and, when queried, indicates whether compensation needs to be performed or not. See [Chapter 6, “HP-IB Syntax Diagrams,” on page 169](#) for a listing of all programming syntax for the Cellular Adapter.

Selecting the Correct Vocoder

Two different vocoder standards can be used to test mobiles: VSELP and ACELP. You need to select the proper vocoder for the mobile you are testing. This is done using the **voc:** field on the CALL CONTROL screen.

1. Access the CALL CONTROL screen by highlighting the **More** field and selecting **CALL CNTL** from the list of choices.
2. Set the **System Type** to **DCCH**.
3. Select the **voc:** field and choose the appropriate vocoder standard.

Product Description

This chapter shows the TIA/EIA-136 screens and explains their purpose. It also identifies features of the Cellular Adapter.

Purpose of this Cellular Adapter

This Cellular Adapter in conjunction with the HP 8920 Series RF Communications Test Set enables testing of the following cellular systems: TIA/EIA-136 (DCCH), TIA/EIA-627 (DAMPS or TDMA), and AMPS. This Cellular Adapter contains the hardware and firmware necessary to test DCCH and DAMPS. The AMPS hardware and firmware is contained in the HP 8920.

Table 1 DAMPS and DCCH Channels

DAMPS (TIA/EIA-627)	DCCH (TIA/EIA-136)
Digital Traffic Channel	Digital Traffic Channel
Analog Voice Channel	Analog Voice Channel
Analog Control Channel	Analog Control Channel
-	Digital Control Channel

If you want to test a TIA/EIA-136 mobile, use System Type DCCH. If you want to test an TIA/EIA-627 phone, use System Type DAMPS.

Items in this manual are valid for both DCCH and DAMPS, unless otherwise noted. Symbols that alert you to system-specific topics are shown in [Figure 10](#).

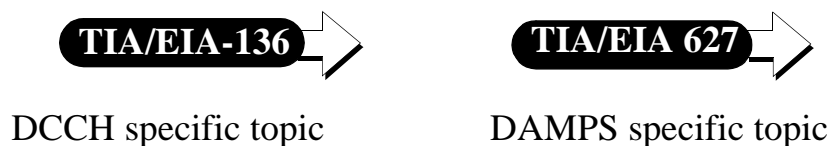

Figure 10 Symbols Used to Identify System-Specific Topics

To choose between the DCCH and DAMPS systems, do the following:

- 1 Press PRESET on the Test Set to get the Test System into a known state.
- 2 Select **CALL CNTL** from the **To Screen** (use **More** to display the **CALL CNTL** choice).
- 3 Choose your desired system from the **System Type** field. DCCH is the TIA/EIA-136 system, DAMPS is the TIA/EIA-627 system.

The DCCH Call Processing Screens

The Cellular Adapter provides a set of screens which emulates a cellular base station. This set of screens for DCCH is called the DCCH Call Processing Subsystem. The screens enable you to see data which has been transmitted between the mobile and the base station, and to make measurements of channel parameters.

The primary screen is the CALL CONTROL screen. From the CALL CONTROL screen you can access other screens in the DCCH Call Processing Subsystem. Note that these DCCH screens are only available when the **System Type** field on the CALL CONTROL screen is set to DCCH.

For detailed descriptions of each field on the call processing subsystem screens, see [Chapter 7, “Screen and Field Descriptions,” on page 205](#).

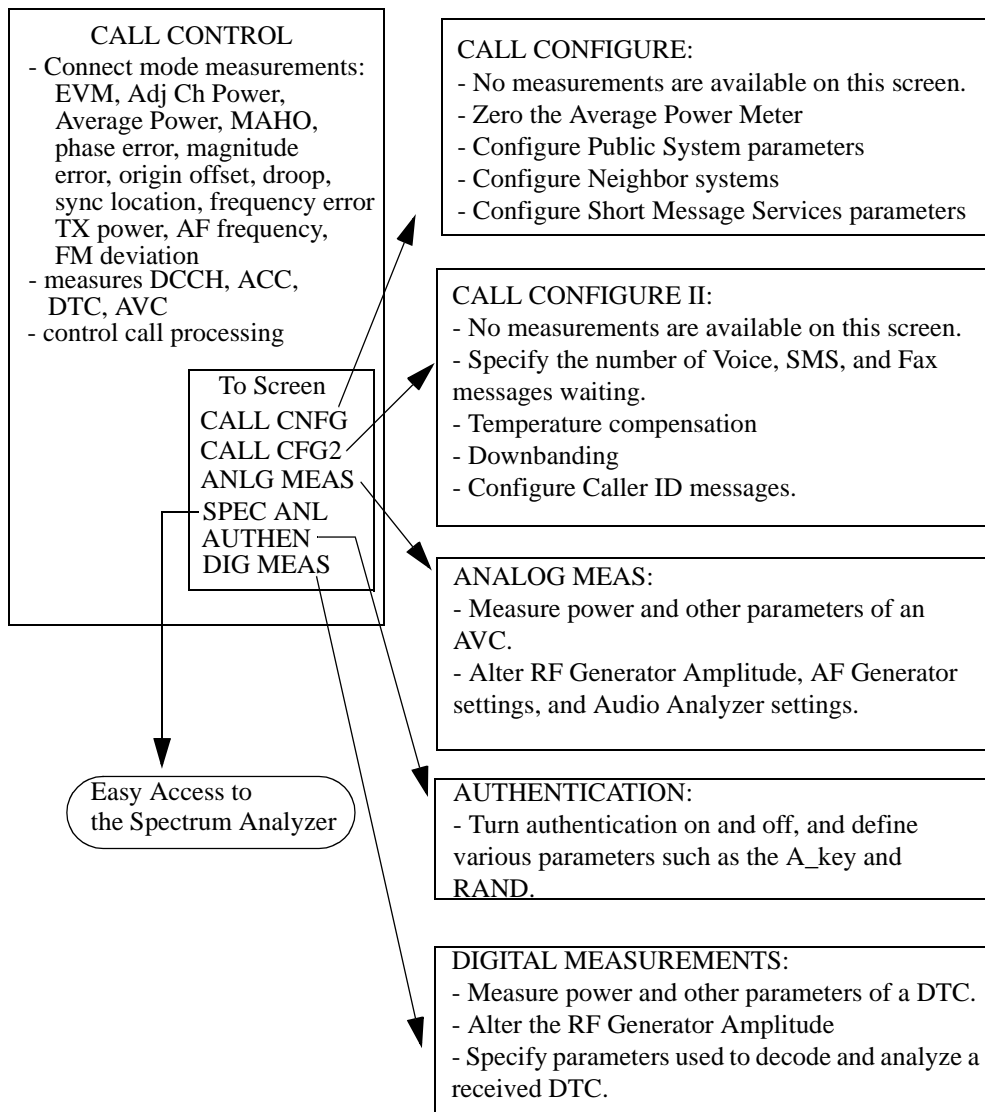

Figure 11 **The Screens for Testing TIA/EIA-136**

To select the primary screen (CALL CONTROL screen), do the following:

- 1 Press PRESET on the Test Set to get the Test System into a known state.
- 2 Select **CALL CNTL** from the **To Screen** (use **More** to display the **CALL CNTL** choice).
- 3 Select **DCCH** from the **System Type** field. Now the TIA/EIA-136 CALL CONTROL screen is displayed.

CALL CONTROL Screen

The CALL CONTROL screen is the primary screen of the DCCH Call Processing Subsystem. It controls call setup and maintenance functions for base station emulation. From this screen, you can set basic parameters of the channel, such as Phone Number, Control Channel Number, Amplitude, Voice Channel, and Power Level.

The CALL CONTROL screen transmits on DCCH, ACC, DTC, or AVC.

The CALL CONTROL screen can display either data or measurements. Select **data** or **measurements** by toggling the **Display** field in the upper-left corner of the screen.

NOTE:

The measurements of the CALL CONTROL screen are only displayed while the Test System is in Connect state; a call must be in process. For measuring parameters without a call in process, see **“DIGITAL MEASUREMENT Screen” on page 55.**

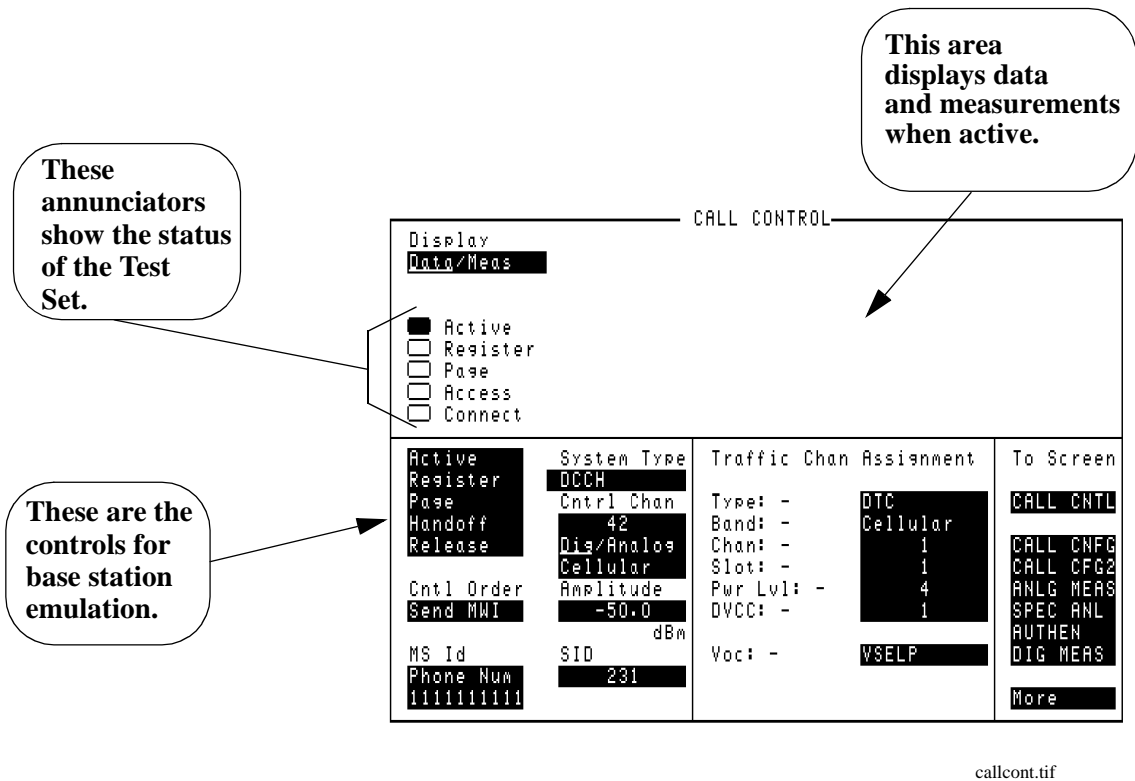

Figure 12

The CALL CONTROL Screen for TIA/EIA-136

**CALL
 CONFIGURE
 Screen**

The CALL CONFIGURE screen provides additional controls for TIA/EIA-136 features. Refer to the field descriptions in [Chapter 7, “Screen and Field Descriptions,”](#) on page 205 for more information.

No data or measurements are displayed on the CALL CONFIGURE screen. The Test Set can be in Connect mode, but no call processing actions can be taken here.

These are the controls available in this screen:

- DVCC value for the DCCH
- SAT tone tolerance
- Zero the power meter
- Downbanding
- IQ modulation switching
- Country Code
- Access burst type
- DTC burst type
- Digital Signal format
- Neighbors configuration
- Short Message Service (SMS)
- Public System

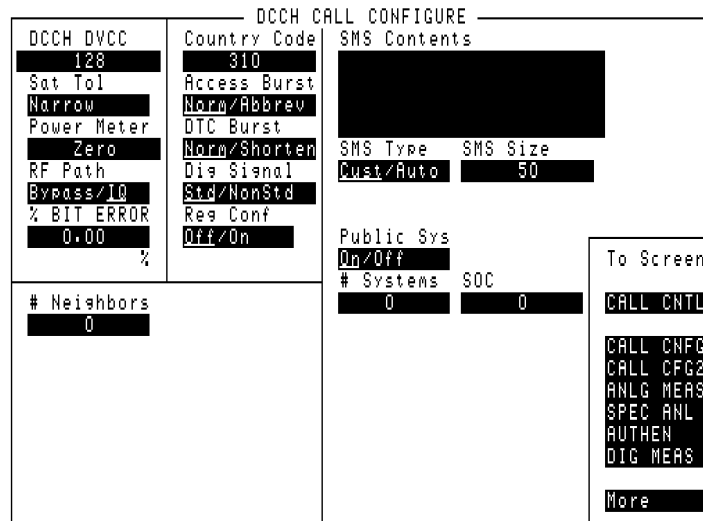

dcch_cc.tif

Figure 13 **The CALL CONFIGURE Screen**

DIGITAL MEASUREMENT Screen

This screen enables measurements on a DTC (Digital Traffic Channel) by using the Mobile Station Test Interface, as specified in TIA/EIA Interim Standard IS-137. It also supports the TIA/EIA-627 Test Interface. Refer to the field descriptions in Chapter 7, “Screen and Field Descriptions,” on page 205 for more information.

The difference between the measurements displayed on this screen and those displayed on the CALL CONTROL screen is the connect state of the Test Set and mobile. The CALL CONTROL screen requires that the Test Set be in the Connect state (that is, maintaining a call with a mobile). The DIGITAL MEASUREMENT screen does not require the Connect state. It does, however, require that the mobile be in a special test mode as described in the standards mentioned earlier.

The test mode is enabled via the test interface. Each manufacturer which supports this test interface provides a connector as per the specification. The individual manufacturer should provide instructions for putting the mobile in the test mode.

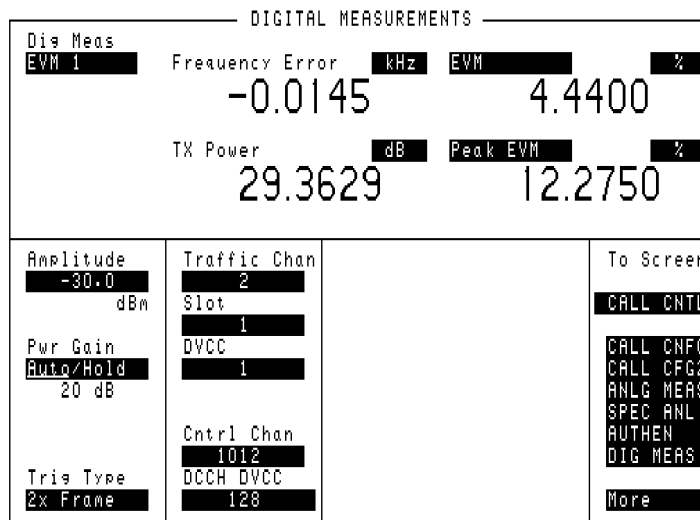

dig_meas.tif

Figure 14

The DIGITAL MEASUREMENT Screen

ANALOG MEASUREMENT Screen

This screen allows you to make measurements on an AVC (Analog Voice Channel). These measurements are the same as the AMPS Analog Measurement screen. Refer to the field descriptions in [Chapter 7, “Screen and Field Descriptions,”](#) on page 205 for more information.

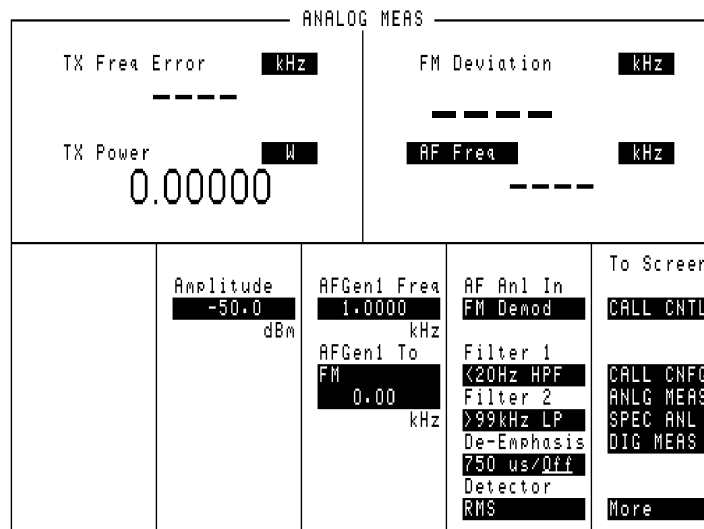

Ana-meas.tif

Figure 15 The ANALOG MEASUREMENT Screen

Tasks You Can Perform with the Cellular Adapter

Call Processing Tasks

The following call processing tasks can be performed with the Cellular Adapter. The measurements which can be performed are listed in the next section.

Call Processing Tasks

TIA/EIA 627

- Call control on Digital and Analog Control Channels (DCCH and ACC)
(ACC only for IS-54)
- Register on Digital Traffic Channel (DTC) or Analog Voice Channel (AVC)
- Page a mobile to connect to a DTC or AVC
- Accept a mobile origination, assign to DTC or AVC
- Handoff from AVC to DTC via either DCCH or ACC
- Handoff from DTC to AVC via either DCCH or ACC
- Release by Test Set
- Release by mobile
- Send Orders (Power level changes)
- Control MAHO (including measuring neighbor channels)
- Slot Changes
- SAT changes
- DVCC codes
- Country code
- Calling number
- Access and DTC burst variations
- Unique programming of FACCH and SACCH messages (via HP-IB only)
- Send Short Message Service messages to the mobile.
- Send Caller ID messages to the mobile.

Measurements and Data available The following measurements can be made with the Cellular Adapter.

- EVM1 (Error Vector Magnitude, measured over 1 time slot)
- EVM10 (EVM of first 10 bits of 10 bursts, averaged)
- BER (bit error rate)
- WER (word error rate)
- adjacent channel power, measured on six adjacent channels
- TX frequency error
- phase error
- magnitude error
- origin offset
- droop
- sync location
- average power (with Option 006)
- TX Power - absolute (with PCS Interface)
- TX Power - relative
- MAHO (mobile reported BER and RSSI)
- MAHO, BER, or WER with inserted bit errors

Use the HP 8920 to Make Other Measurements

This TIA/EIA-136 product is attached to a fully functioning HP 8920B. You can use the Test Set for all of your analog measurements, including AMPS call processing.

If you would like to test a TIA/EIA-136 mobile with an AMPS base station emulation, select **system Type AMPS** in the CALL CONTROL screen. Then the Test Set will emulate an AMPS base station. See the *HP 8920 RF Communications Test Set User's Guide* for more information about the analog call processing subsystem.

If you want to test the analog portion of a TIA/EIA-136 phone with a TIA/EIA-136 base station emulation, select **System Type DCCH** and **Control Channel Type ACC**.

Processing Calls

This chapter explains how to use the DCCH Call Processing screens to perform call processing tasks such as pages, originations, registrations, and so on.

About Call Processing Tasks and Measurements

The Call Processing subsystem of the HP 8920 and Cellular Adapter can be set up to emulate a TIA/EIA-136 standard base station.

Primary call processing tasks such as registrations, pages, handoffs, and releases can be made with just one screen: the CALL CONTROL screen. Some of the major call processing parameters can also be set on this screen. See [“Parameters of the CALL CONTROL Screen” on page 208](#)

More parameters and features, such as Short Message Services, can be controlled with the CALL CONFIGURE screen. See [“Parameters of the DCCH CALL CONFIGURE Screen” on page 220](#)

Message Waiting Indicators and Caller ID features are controlled on the CALL CONFIGURE II screen. See [“Parameters of the DCCH CALL CONFIGURE II Screen” on page 226](#)

Measurements in the Digital test mode can be made in the DIG MEAS screen. See [“Digital Measurement Screen Tests” on page 118](#).

Measurements on the Analog Voice channel can be made in the Connect state or the ANLG MEAS screen. See [“Analog Parameters” on page 113](#)

Authentication is controlled on the AUTHENTICATION screen. See [“Parameters of the DTC AUTHENTICATION Screen” on page 236](#)

PCS measurements

PCS compatible mobiles are tested using the HP 83236B PCS Interface connected to the Test System. After the interface is connected and some controls are set to indicate its presence in the system, you can proceed to test PCS-compatible mobiles the same way you test non-PCS TIA/EIA-136 mobiles. See [“About the PCS Interface” on page 42](#).

Configure the Test Set to Emulate a Base Station

Before you can use the Test Set to perform call processing tasks, it must be configured to emulate the base station.

Use the following procedures to prepare the Cellular Adapter to emulate a base station.

How to emulate a base station

- A Access the DCCH CALL CONTROL screen. See “A. How to access the DCCH CALL CONTROL screen” on page 65
- B Set up the basic channel parameters. See “B. Make the following settings on the CALL CONTROL screen:” on page 65
- C Define the type of mobile you are testing (PCS or cellular) and compensate for temperature variation if a PCS Interface is present. See “C. Make the following settings on the CALL CONFIGURE II screen:” on page 66
- D Put the Test Set in Active state to emulate a base station. See “D. Put the Test Set in Active state to emulate a base station” on page 67

Once you have the Test Set configured, you are ready to perform call processing tasks such as origination, registration, and so on.

PCS OPERATION

If you are using the PCS Interface, be sure to turn on the interface before turning on the Test Set. Also, set the **PCS Mode** field on the CONFIGURE screen to **On** before accessing the CALL CONTROL screen to test a mobile.

SAVING YOUR TEST SYSTEM CONFIGURATION

After configuring the Test System to meet your test needs, you can save the configuration for later use in a SAVE/RECALL register. This eliminates the need to manually reconfigure the Test System each time you use it.

There are two ways to save your test configuration:

- 1) Press SHIFT, RECALL (SAVE), and enter a name (such as DCCH_PCS). The next time you turn the Test System on, you can press RECALL and select the name you entered. The Test System returns to the same state it was at when you saved the settings.
- 2) Press SHIFT, RECALL (SAVE), and enter the name “POWERON”. The next time you turn the Test System on, the Test System will *automatically* re-establish all settings you saved.

**CAUTION: SAVING
SETTINGS FOR PCS
OPERATION**

To use SAVE/RECALL registers, you *must* use the same hardware configuration present at the time the register is created. If you save instrument settings when a PCS Interface is connected to the Test Set, the Test Set expects to detect the presence of the interface when the register is recalled. If the PCS Interface is not connected to the Test Set when the register is recalled, or the interface is turned off, a non-recoverable firmware error occurs. If you encounter this error, the Test Set must be turned off, and the PCS Interface must be connected and turned on, before the Test Set can power up normally and function correctly.

**Emulating a Base
Station**

A. How to access the DCCH CALL CONTROL screen

1. Verify that you have already done the following (refer to [Chapter 1, “Getting Started,”](#) on page 31):
 - Zeroed the RF Power meter
 - Selected the proper audio filter, if you want to test audio
 - Connected the mobile to the Test Set
2. Select **CALL CNTL** from the **To Screen**. The CALL CONTROL screen will be displayed.
3. Select **DCCH** from the **System Type** field. Now the CALL CONTROL screen shows the parameters necessary to test TIA/EIA-136 mobiles.

B. Make the following settings on the CALL CONTROL screen:

System Type: DCCH

Define the settings for the control channel that you want your mobile to access on power up:

Cntrl Chan: enter your desired control channel number.

- Choose **Dig** if you want the DCCH
- Choose **Analog** if you want the ACC
- Choose **Cellular** to camp on a 850 MHz band control channel.
- Choose **PCS** if you want to camp on a 1900 MHz band control channel.

Amplitude: enter the amplitude of the control channel.

SID: enter the System Identification (in decimal format) of the base station to be emulated.

Configure the Test Set to Emulate a Base Station

Define the settings for the traffic channel that you want your mobile to be assigned to when establishing a call:

- Choose **DTC** to set up a Digital Traffic channel.
 - **Type: DTC**
 - **Band:** Select PCS or Cellular.
 - **Chan:** Enter your desired channel number
 - **Slot:** Enter your desired slot number.
 - **Pwr Lvl:** Enter your desired power level.
 - **DVCC:** Enter your desired DVCC.
- Choose **AVC** to set up a Analog Voice channel.
 - **Type: AVC**
 - **Chan:** Enter your desired channel number.
 - **Pwr Lvl:** Enter your desired power level.
 - **SAT:** Choose your desired SAT frequency.
- **Voc:** Select the type of vocoder used by the mobile.
 - **VSELP** is most often used for non-PCS compatible mobiles.
 - **ACELP** is most often used for PCS-compatible mobiles.

C. Make the following settings on the CALL CONFIGURE II screen:

- Select **CALL CFG2** from the **To Screen** menu.
- Choose **MS Capab** to indicate the type of mobile you are testing.
 - Select **Cellular** if the mobile is not PCS-compatible.
 - Select **US PCS** if your mobile is PCS-compatible.
- *If a PCS Interface is used:* Select **Temperature** to compensate for temperature changes in the PCS Interface.
- Press the PREV key to return the CALL CONTROL screen (or select CALL CNTL from the **To Screen** menu).

D. Put the Test Set in Active state to emulate a base station

1. Select **Active** from the list on the left side of the screen.
2. The Active annunciator lights up when the Test Set is emulating a base station.

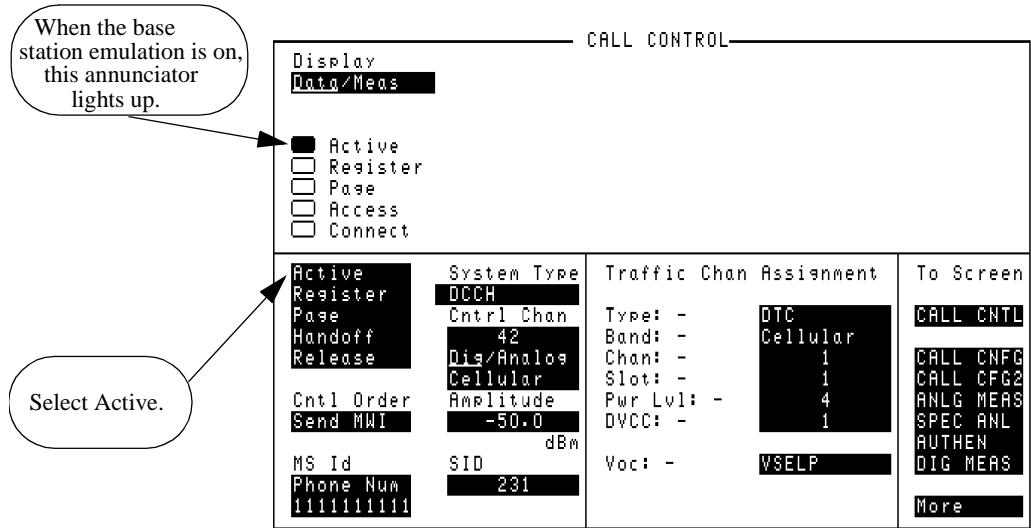

callcont.tif

Figure 16

CALL CONTROL Screen with Test Set in Active State

How to know when the call is dropped There are several ways the Test Set notifies you when a call has been dropped. Any of the following situations may occur.

Connect state ends

If the Connect annunciator goes off, and the Test Set returns to the Active state, the call has dropped or ended.

DTC is not detected

If communication fails on the Reverse DTC, a message will appear at the top of the screen: **“No Reverse DTC is being detected, loss of Traffic Channel.”** The Test Set will return to Active state.

Analog connection ends

If communication fails on the AVC, a message will appear at the top of the screen: **“RF Power Loss indicates loss of Voice Channel.”** The Test Set will return to Active state.

Call Processing Procedures

You can use the procedures in this chapter to test your mobile station. In the following list, the most commonly used procedures are listed first. The procedures are presented alphabetically by procedure name.

- “Registration” on page 93
- “Page” on page 91
- “Origination” on page 89
- “Handoff” on page 83
- “Orders” on page 88
- “Release by Mobile” on page 95
- “Release by Test Set” on page 96
- “MAHO” on page 86
- “Caller ID” on page 79
- “Authentication” on page 70
- “Message Waiting Indicator” on page 87
- “Country Code” on page 80
- “FACCH SACCH Programming” on page 82
- “Downbanding” on page 81

Authentication

The process of testing DCCH authentication (TIA/EIA-136) through the Call Processing Subsystem requires the user to synchronize the base station and mobile station. This synchronization requires that the base station and the mobile station possess two pieces of shared secret data (SSD) to confirm a valid call. The first piece is the **ESN** of the mobile station and the second piece is the mobile station's **A-key**. The A-key is a secret 26-digit number stored in the mobile station's semi-permanent memory. The following sections describe how to:

- Initialize Call Processing with Authentication
- Page a Mobile Station with Authentication
- Originate a Call with Authentication
- Perform an SSD Update
- Perform a Unique Challenge

These procedures assume you understand how to configure the Test System to emulate a base station. (See [“Configure the Test Set to Emulate a Base Station”](#) on page 64)

DTC AND AVC AUTHENTICATION SETTINGS

The authentication settings used when connected on a DTC are somewhat different than those used on an AVC. Basically, the RANDSSD data and A_KEY information are entered differently. Otherwise, operation is the same.

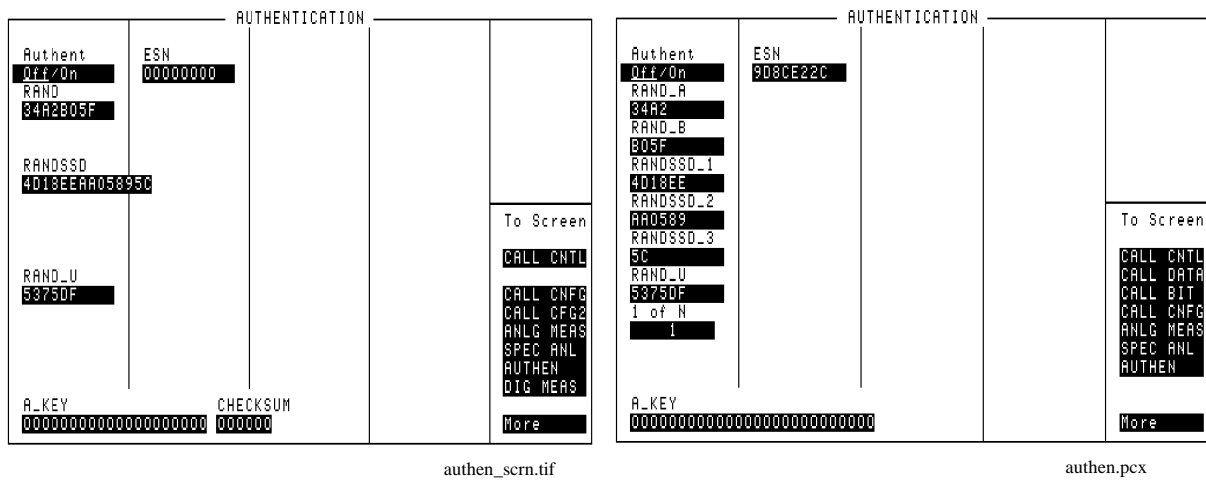

The above settings are used when the mobile is camped on a DCCH, or is connected on a DTC.

The above settings are used when the mobile is connected on an AVC.

Figure 17 Authentication Screen Differences

Initialize Call Processing with Authentication

There are two methods to initialize Call Processing with authentication.

- Initializing Call Processing with Authentication through registration with the Test Set.
- Initializing Call Processing with Authentication without registration with the Test Set.

Initialize Call Processing with Authentication through Registration

1. On the CALL CONTROL screen, set the **System Type** to **DCCH** and verify that the **Active** annunciator is lit.
2. Connect the mobile station to the Test Set as shown in [Figure 5 on page 38](#)
3. Turn on the mobile station.
4. Verify that the mobile station is camped on the control channel.
5. Select the **Register** field. The **Register** annunciator lights while the registration is in process. If the mobile station responds properly on the reverse control channel, the mobile station's phone number, ESN, SCM, protocol version, and model are displayed in the upper right-hand portion of the CALL CONTROL screen. The information in the **MS Id** field is updated. The **Active** annunciator lights when the registration has successfully completed.
6. Select **AUTHEN** on the **To Screen** field. The AUTHENTICATION screen is displayed.
7. Select the **A_KEY** field and enter the first 20 digits of a valid A_KEY in decimal format.
8. Position the cursor on the **Off/On** field and select **On**.
9. Select **CALL CNTL** from the **To Screen** menu. The CALL CONTROL screen is displayed.
10. Select **SSD Upd** in the **CC Order** field. The Access annunciator light lights while the SSD Update order is in progress. If the mobile station responds properly on the reverse control-channel, "**SSD Update Order Successful**" is displayed in the upper right-hand portion of the CALL CONTROL screen. The test set and the mobile station now share common secret data and further call processing functions with authentication can be tested. If the order failed, then "**SSD Update Order Failed**" appears on the upper right-hand portion of the CALL CONTROL screen.

Initializing Call Processing with Authentication without Registration

1. On the CALL CONTROL screen, set the **System Type** to **DCCH** and verify that the **Active** annunciator is lit.
2. Connect the mobile station to the Test Set as shown in [Figure 5 on page 38](#).
3. Turn on the mobile station.
4. Verify that the mobile station is camped on the control channel.
5. Select the upper **MS ID** field and then select **MIN2 MIN1** from the Choices: menu.
6. Select the lower **MS ID** field and enter the Mobile Identification Number (MIN) in hexadecimal format.
7. Select **AUTHEN** from the To Screen menu. The AUTHENTICATION screen is displayed.
8. Select the A_KEY field and enter the first 20 digits of a valid A_KEY in decimal format.
9. Select the ESN field and enter the mobile station's electronic serial number in a hexadecimal format.
10. Position the cursor on the **Off/On** field and select **On**.
11. Select **CALL CNTL** from the **To Screen** menu. The CALL CONTROL screen is displayed.
12. Select **SSD Upd** from the **CC Order** field. The Access annunciator lights while the SSD Update order is in progress. If the mobile station responds properly on the reverse control-channel, "**SSD Update Order Successful**" is displayed in the upper portion of the CALL CONTROL screen. The test set and the mobile station now share common secret data and further call processing functions with authentication can be tested. If the order failed, then "**SSD Update Order Failed**" appears on the upper portion of the CALL CONTROL screen.

Page a Mobile Station with Authentication

Paging A Mobile Station That Has Registered With The Test Set

1. Register the mobile with the Test System. See [“Initialize Call Processing with Authentication through Registration” on page 72](#)
2. Select the **Page** field. The **Page** annunciator lights while the Test Set pages the mobile on the forward control channel. The mobile station should ring.
3. Press the SEND key on the mobile station. The **Connect** annunciator lights if the mobile station properly signals the Test Set. The mobile station is now connected to the Test Set on the assigned voice channel. The **Traffic Chan Assignment** fields is updated, that is, any “-” in the left-hand fields are replaced with appropriate information. If page with authentication was successful, **“Page w/Auth successful”** is displayed in the last line of information in the upper part of the CALL CONTROL screen. If page with authentication failed, then **“Page w/Auth failed”** is displayed.

Originate a Call with Authentication

1. Register the mobile with the Test System. See [“Initialize Call Processing with Authentication through Registration” on page 72](#)
2. Dial the desired phone number on the mobile station and press the SEND key on the mobile station’s handset. The mobile station signals the Test Set on the reverse control channel with an origination message which includes the dialed phone number, the mobile station’s MIN number and the mobile station’s ESN.

If the mobile station transmitted properly on the reverse control channel, the mobile station’s phone number, ESN, decoded SCM, protocol version, and called phone number are displayed. The Test Set then reconfigures itself to the traffic channel assignments set up in the **Traffic Chan Assignment** section of the CALL CONTROL screen. The **Access** annunciator is lit while the Test Set signals the mobile station on the assigned voice channel. The **Connect** annunciator lights if the mobile station properly signals the Test Set on the reverse voice channel.

The mobile station is now connected to the Test Set on the assigned voice channel. The **Traffic Chan Assignment** fields are replaced with appropriate information. If origination with authentication was successful, then **“Origination w/Auth successful”** is displayed with the other returned mobile information in the upper portion of the CALL CONTROL screen. If origination with authentication failed, then **“Origination w/Auth failed”** is displayed.

Perform an SSD Update

There are two methods that can be used to perform an SSD Update:

- SSD Update on the Control Channel
- SSD Update on the Voice Channel

Performing an SSD Update on the Control Channel

1. Ensure that the Test Set has Initialized Call Processing with Authentication. See [“Initialize Call Processing with Authentication through Registration”](#) on page 72 for information on how to register the mobile station and activate Authentication.
2. Select **AUTHEN** on the **To Screen** menu. The AUTHENTICATION screen will be displayed.
3. Select **RANDSSD** field. Enter a new, valid RANDSSD value (14-digit hexadecimal).
4. Select **CALL CNTL** under the **To Screen** menu. The CALL CONTROL screen will be displayed.
5. Select **SSD Upd** on the **CC Order** field. The **Access** annunciator lights while the SSD Update order is in progress. If the mobile station responds properly on the reverse control channel, **“SSD Update Order Successful”** is displayed in the upper portion of the CALL CONTROL screen. The Test Set and the mobile station are now linked and further call processing functions with authentication can be tested. If the order failed, then **“SSD Update Order Failed”** appears in the upper portion of the CALL CONTROL screen.

Performing an SSD Update on the Voice Channel

A registered mobile can be paged to go to either a digital traffic channel (DTC) or an analog voice channel (AVC). The type of channel assigned depends on the **Voice Channel Assignment - Type** setting present when the mobile was paged.

The AUTHENTICATION screen's field choices are different for these two channel types. The following procedure indicates where the difference in fields requires different Test System settings. See [“Parameters of the DTC AUTHENTICATION Screen” on page 236](#) and [“Parameters of the AVC AUTHENTICATION Screen” on page 239](#).

1. Ensure that the Test Set has Initialized Call Processing with Authentication. See [“Initialize Call Processing with Authentication through Registration” on page 72](#) for information on how to register the mobile station and activate Authentication.
2. Ensure that the mobile station is on a voice channel. See [“Page a Mobile Station with Authentication” on page 74](#)
3. Set the **Display** field to **Data**.
4. Select **AUTHEN** from the To Screen menu. The AUTHENTICATION screen will be displayed.

For Authentication on a DTC

- a. Select the **RANDSSD** field. Enter a new, valid RANDSSD value (14-digit hexadecimal).

For Authentication on an AVC

- a. Select the **RANDSSD_1** field. Enter a new, valid RANDSSD_1 value (6-digit hexadecimal).
- b. Select the **RANDSSD_2** field. Enter a new, valid RANDSSD_2 value (6-digit hexadecimal).
- c. Select the **RANDSSD_3** field. Enter a new, valid RANDSSD3 value (2-digit hexadecimal).
5. Select **CALL CNTL** under the **To Screen** menu. The CALL CONTROL screen will be displayed.
6. Select **SSD Upd** on the **VC Order** field. The **Access** annunciator lights while the SSD Update order is in progress. If the mobile station responds properly on the reverse control channel, **“SSD Update Order Successful”** is displayed in the upper portion of the CALL CONTROL screen. If the order failed then **“SSD Update Order Failed”** appears in the upper portion of the CALL CONTROL screen.

Perform a Unique Challenge

There are two methods that can be used to perform a Unique Challenge-Response procedure:

- Unique Challenge on the Control Channel
- Unique Challenge on the Voice Channel

Performing a Unique Challenge on the Control Channel

1. Ensure that the Test Set has Initialized Call Processing with Authentication. See [“Initialize Call Processing with Authentication through Registration”](#) on page 72 for information on how to register the mobile station and activate Authentication.
2. Select **AUTHEN** on the To Screen menu. The AUTENTICATION will be displayed.
3. Select **RAND_U** field. Enter a new, valid RAND_U value (6-digit hexadecimal).
4. Select **CALL CNTL** under the **To Screen** menu. The CALL CONTROL screen will be displayed.
5. Select **Uniq Chal** from the **CC Order** field. The **Access** annunciator lights while the Unique Challenge order is in progress. If the mobile station responds properly on the reverse control channel, **“Unique Challenge Successful”** is displayed in the upper portion of the CALL CONTROL screen. If the order failed, then **“Unique Challenge Failed”** appears on the upper portion of the CALL CONTROL screen.

Performing a Unique Challenge on the Voice Channel

1. Ensure that the Test Set has Initialized Call Processing with Authentication. See [“Initialize Call Processing with Authentication through Registration”](#) on page 72 for information on how to register the mobile station and activate Authentication.
2. Ensure that the mobile station is assigned an active voice channel. See [“Page a Mobile Station with Authentication”](#) on page 74
3. Set the **Display** field to **Data**.
4. Select **AUTHEN** from the To Screen menu. The AUTHENTICATION screen will be displayed.
5. Select the **RAND_U** field. Enter a new, valid RAND_U value (6-digit hexadecimal).
6. Select **CALL CNTL** from the **To Screen** menu. The CALL CONTROL screen will be displayed.
7. Select **Uniq Ch** from the **VC Order** field. The **Access** annunciator lights while the Unique Challenge order is in progress. If the mobile station responds properly on the reverse control channel, **“Unique Challenge Successful”** is displayed in the upper portion of the CALL CONTROL screen. If the order failed, then **“Unique Challenge Failed”** appears on the upper portion of the CALL CONTROL screen.

Caller ID

Caller ID sends a specially formatted message to the mobile under test that identifies the phone number and name of the person calling.

The Caller ID fields are located on the DCCH CALL CONFIGURE II screen.

1. Select **CALL CFG2** from the CALL CONTROL's **To Screen**.
2. Select **Calling Num** and enter the number for the phone calling the mobile.
3. Select **Calling Name** and enter the name assigned to the number calling the mobile.
4. Select **Name Size** and enter the number of characters of the **Calling Name** to send.
5. Select **Pres Type** and select the type of Caller ID presentation:
 - **Pres OK** allows the Calling Name and Calling Number to be sent.
 - **Pres Res** restricts the information.
 - **Not Avail** tells the mobile that no information is available.

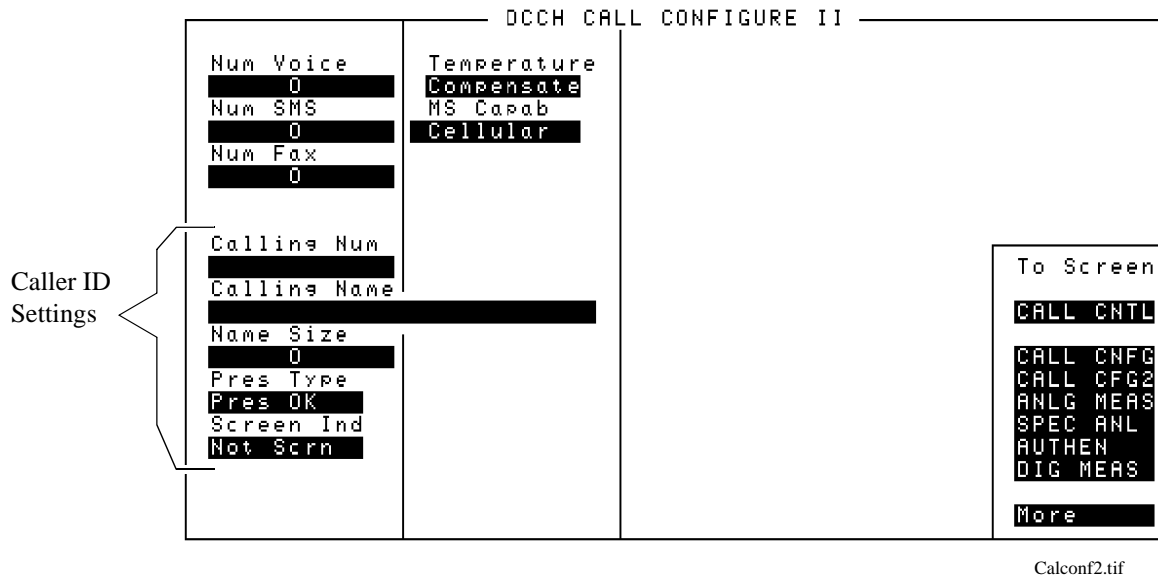

Figure 18

Calling Number Display

Country Code

You can define the country code with this field. Mobile Country Code (MCC) assignments are as described in CCITT Recommendation E.212.

Table 2 Some Mobile Country Codes

Code	Country
302	Canada
334	Mexico
310-316	United States of America
244	Finland
425	Israel
450	Korea
262	Germany
214	Spain
234-235	United Kingdom of G. Britain and N. Ireland

1. select **CALL CNFG** from the CALL CONTROL's **To Screen**.
2. Select **Country Code**.
3. Enter the desired country code.

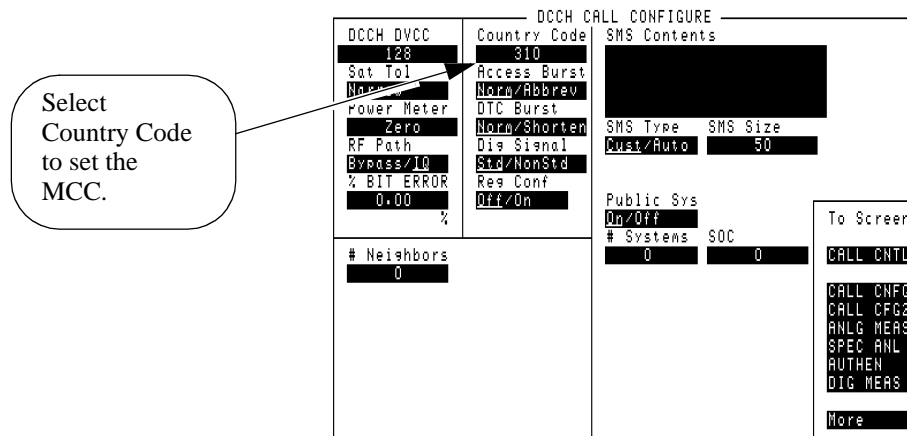

dcch_cc.tif

Downbanding

Downbanding is a specialized function which enables the Test Set to work in a band just below the cellular band. By choosing the downband (Band 10) function, the Test Set emulates a base station with channels numbered 1-600, in the frequency band 851 - 869 MHz.

If the Test Set was in Active state when you select **Band 10**, the Test Set will return to Active state on the new downbanded frequency. If the Test Set was in Connect state, you must first Handoff to the new frequency.

1. Select **CALL CFG2** from the CALL CONTROL's **To Screen**.
2. Select the **MS Capab** field and choose **Band 10** from the list of choices to turn downbanding on.
3. Select **Handoff** in the CALL CONTROL screen to go to the new frequency band.

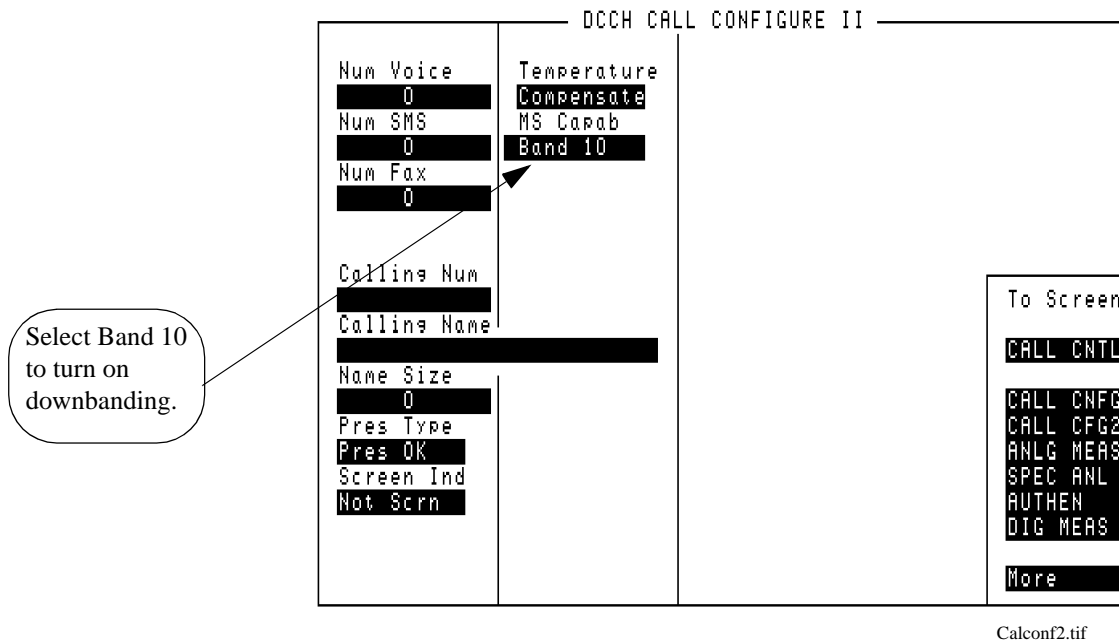

Figure 19

Downbanding

FACCH SACCH Programming

FACCH and SACCH are signaling channels used for transmitting control and supervisory messages between the base and the mobile. FACCH (Fast Associated Control CHannel) is used to transmit from the base to the mobile, and SACCH (Slow Associated Control CHannel) is used to transmit from the mobile to the base.

These channels are controlled in the Test Set via HP-IB programming only. Refer to [“FACCH and SACCH programming” on page 159](#) and [Chapter 6, “HP-IB Syntax Diagrams,” on page 169](#) for more information.

Handoff

See “[Program Example](#)” on page 149 for an example of the equivalent HP-IB command.

1. Verify that the Test Set is in the Connect state (“[Page](#)” on page 91).
2. In the Traffic Chan Assignment section of the screen (or Voice Chan Assignment if you are on an AVC), you must now set the following parameters:

Parameters for setting up a handoff

- a. Enter the type of traffic channel (DTC or AVC).
 - b. Select the frequency band (Cellular or PCS)
 - c. Enter the number of the voice or traffic channel to handoff to.
 - d. Enter the power level that the mobile will change to.
 - e. Enter the slot number for the new channel if it is a DTC (or SAT if AVC).
 - f. Change DVCC, if desired.
3. Select **Handoff** from the list on the left side of the screen.
 4. When the handoff is complete, the data for the new DTC or AVC will be displayed on the screen in the left side of the Traffic or Voice Chan Assignment area.

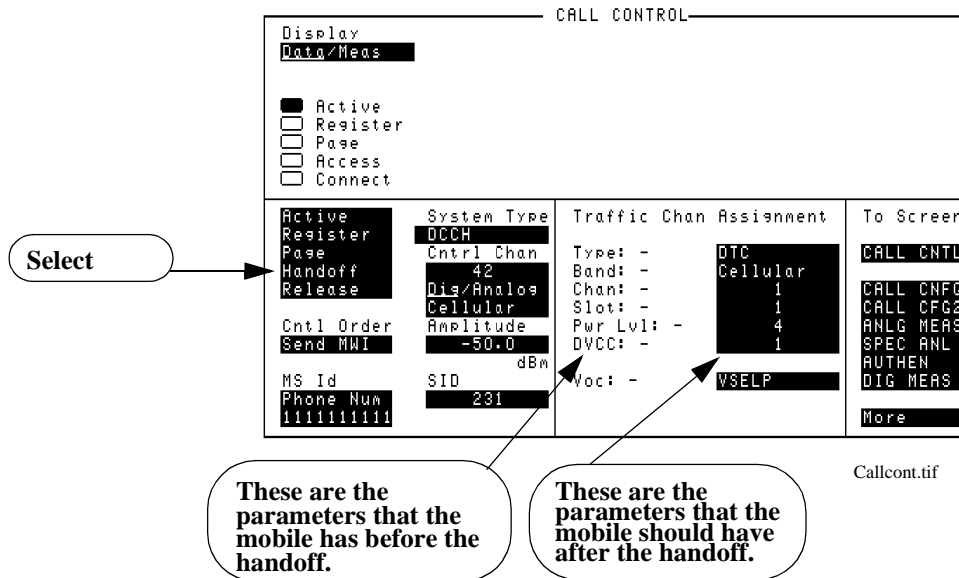

Figure 20 CALL CONTROL Screen with Handoff Data Displayed

Choosing the proper combination of DVCC, slot, and channel number

The TIA/EIA-136 specification indicates that on any single RF channel, the DVCC for all slots must be the same. For example, if your DCCH is assigned to channel 42, and you assign the mobile to a DTC of 42, then the DVCC for both the DCCH and the DTC must be the same.



Additionally, the specification requires that the DTC, if assigned on the same channel, be assigned to a different slot than the DCCH. The Test Set always assigns the DCCH to slots 1 and 4. If you assign your DTC to the same channel number, and assign the DTC to slot 1 or 4, the Test Set will remain in the Access state when you attempt to originate or handoff.

Select **Active** again to return the Test Set to the Active state. You must then change settings of the DVCC, slot, or channel numbers in order to prevent this from re-occurring.

What you should do:

- Don't use the same RF channel number for both DCCH and DTC.
- If you need to use the same RF channel number for both, then verify that the
 - slot number of the DTC \neq slot number of the DCCH (1 or 4), and
 - DVCC of the DTC = DVCC of the DCCH

MAHO

For details about mobile assisted handoff (MAHO) see [“MAHO” on page 124](#).

Message Waiting Indicator

Message Waiting Indicator (MWI) sends a command to a mobile to tell it that one or more messages are waiting to be read or listened to. The mobile can either be camped on a DCCH or be connected to a DTC to receive the message.

The **Send MWI** command sends the values of the **Num Voice**, **Num SMS**, and **Num Fax** fields of the CALL CONFIGURE II screen.

Specifying the Message Waiting Indicator Contents

1. The mobile must either be camped on a DCCH or connected on a DTC.
2. Select **CALL CFG2** from the CALL CONTROL screen's **To Screen** menu.
3. Enter the number of voice messages you want indicated using the **Num Voice** field.
4. Enter the number of short message service (SMS) messages you want indicated using the **Num SMS** field.
5. Enter the number of fax messages you want indicated using the **Num Fax** field.
6. Return to the CALL CONTROL screen (press the PREV key, or use the To Screen menu).

Sending the MWI Message

1. If the mobile is camped on a DCCH, select the **Cntl Order** field and select **Send MWI**.
2. If the mobile is connected on a DTC, select the **Order** field and select **Send MWI**.

The contents of these fields are sent when a **Send MWI** command is selected on the CALL CONTROL screen. The mobile should then indicate that the specified number of each type of message is waiting to be read or listened to.

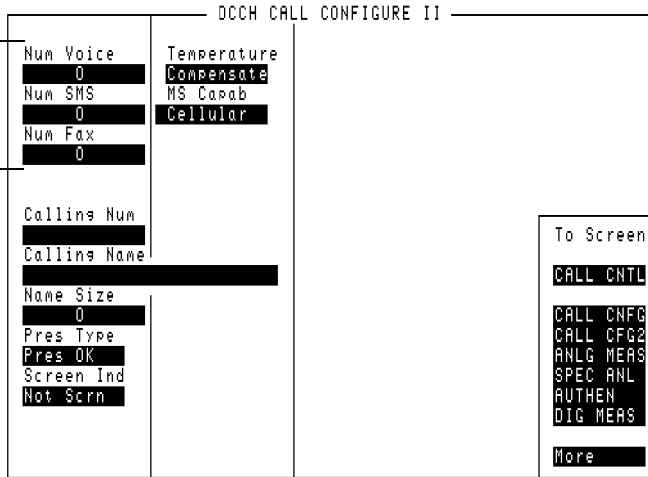

Calconf2.tif

Orders

Note that the available choices in the **Order** field are valid choices for the current channel only. See “Program Example” on page 149 for an example of the program command. (See also “Which Control Order Command Should I Use?” in the *HP 8920B Option 801 Condensed Programming Reference*.)

1. Verify that the Test Set is in the Connect state. (See “Page” on page 91)
2. Select the **Order** field on the left side of the screen.
3. Select the desired order from the list of Orders.
4. The Access annunciator will light briefly while the Test Set sends the order to the mobile.
5. When the mobile has acknowledged the order, the screen will display the acknowledgment.

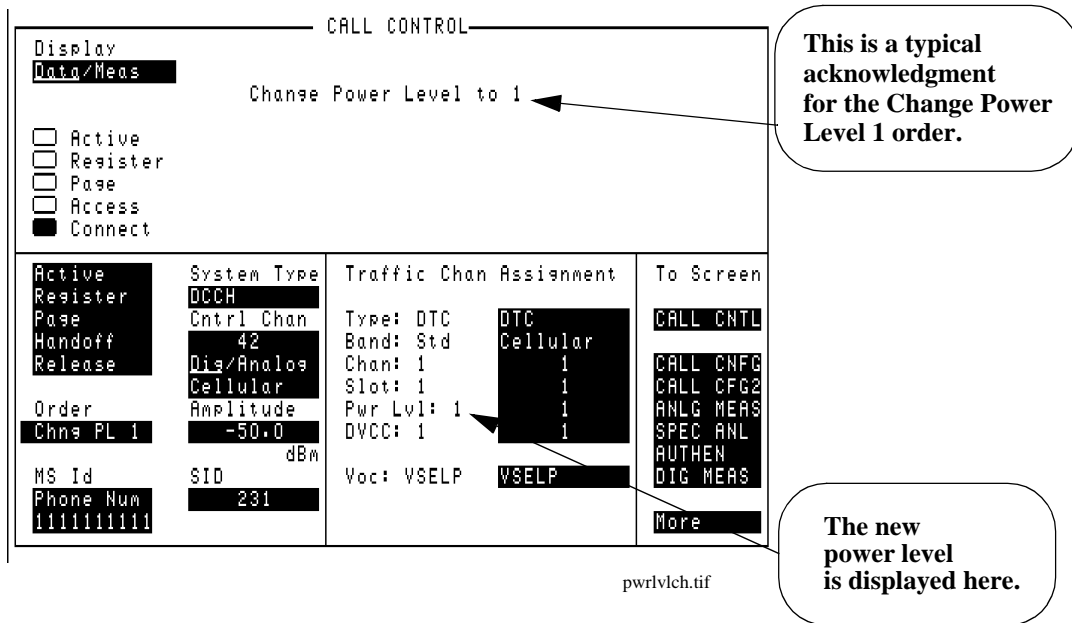

Figure 21

CALL CONTROL Screen with an Order Response Displayed

Origination

When the mobile originates a call, the Test Set automatically assigns the call to the DTC or AVC indicated on the CALL CONTROL screen.

The number that the mobile has called is displayed.

Read about choosing the proper DVCC, slots, and channel numbers in [“Choosing the proper combination of DVCC, slot, and channel number”](#) on page 84.

1. Verify that you have already done the following (refer to [“Configure the Test Set to Emulate a Base Station”](#) on page 64):
 - Zeroed the RF Power meter to your satisfaction.
 - Selected the proper audio filter, if you want to test audio.
 - Put the Test Set in Active state.
 - Connected the mobile to the Test Set and turned the mobile’s power on.
2. Display the CALL CONTROL screen.
3. Select **Data** from the **Data/Meas** field.
4. Dial the desired phone number on the mobile station and press SEND.
5. The mobile station’s phone number, ESN in decimal and hexadecimal, SCM, protocol version, and the number called will be displayed.
6. The Access annunciator will light while the Test Set signals the mobile on the assigned voice channel.
7. The Connect annunciator will light if the mobile properly signals the Test Set on the reverse voice channel.

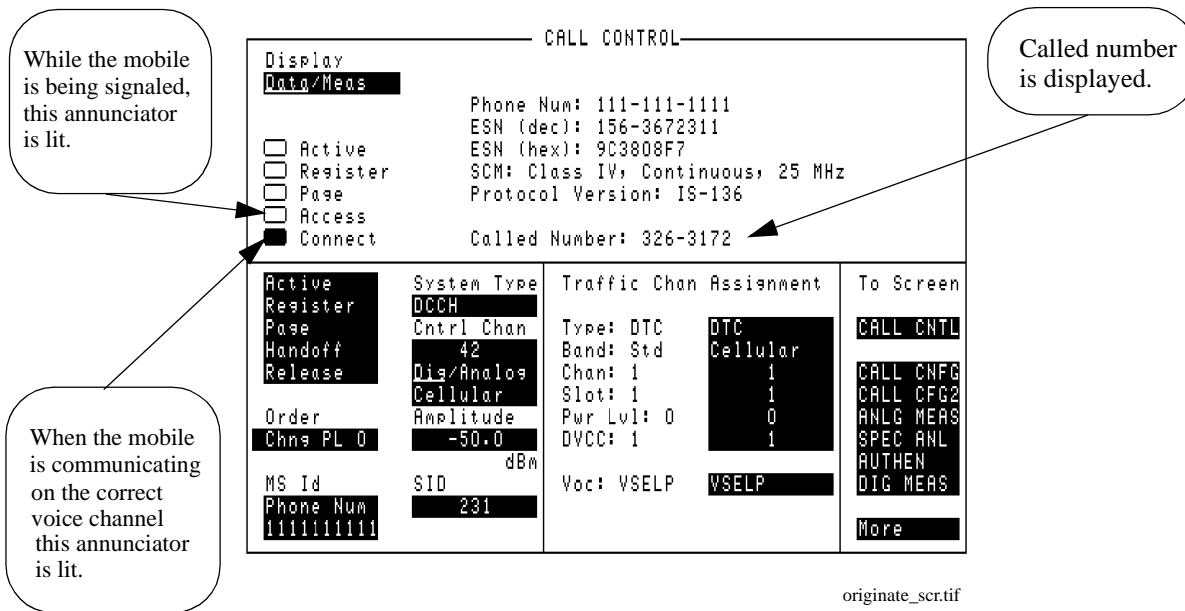

Figure 22 CALL CONTROL Screen After a Successful Origination

Choosing the proper combination of DVCC, slot, and channel number

The TIA/EIA-136 specification indicates that on any single RF channel, the DVCC for all slots must be the same. For example, if your DCCH is assigned to channel 42, and you assign the mobile to a DTC of 42, then the DVCC for both the DCCH and the DTC must be the same.

TIA/EIA-136

Additionally, the specification requires that the DTC, if assigned on the same channel, be assigned to a different slot than the DCCH. The Test Set always assigns the DCCH to slots 1 and 4. If you assign your DTC to the same channel number, and assign the DTC to slot 1 or 4, the Test Set will remain in the Access state when you attempt to originate or handoff.

Select **Active** again to return the Test Set to the Active state. You must then change settings of the DVCC, slot, or channel numbers in order to prevent this from re-occurring.

What you should do:

- Don't use the same RF channel number for both DCCH and DTC.
- If you need to use the same RF channel number for both, then verify that the
 - slot number of the DTC ≠ slot number of the DCCH (1 or 4), and
 - DVCC of the DTC = DVCC of the DCCH

Page

See “Program Example” on page 149 for an example of the program command.

1. Verify that you have already done the following (refer to “Configure the Test Set to Emulate a Base Station” on page 64):
 - Zeroed the RF Power meter
 - Put the Test Set in Active state
 - Connected the mobile to the Test Set and turned the mobile’s power on
 - Registered the mobile. (See “Registration” on page 93)
2. If you registered the mobile, the Mobile Station ID (phone number) of the mobile appears in the **MS ID** field. Otherwise, you must enter this number.
3. Select **Page** from the list on the left side of the screen.
4. If the mobile responds, you will see the Access annunciator light briefly.
5. Press SEND on the mobile to start the conversation.
6. The Connect annunciator lights. This is the Connect state. Data to be displayed is shown below.

CALL CONTROL

Display
Data/Meas

Phone Num: 111-111-1111
ESN (dec): 156-3672311
ESN (hex): 9C3808F7
SCM: Class IV, Continuous, 25 MHz
Protocol Version: IS-136

Active
 Register
 Page
 Access
 Connect

Active	System Type	Traffic Chan Assignment	To Screen
Register	DCCCH	Type: DTC	CALL CNTL
Page	Cntrl Chan	Band: Std	CALL CNFG
Handoff	42	Chan: 1	CALL CFG2
Release	Dig/Analog	Slot: 1	ANLG MEAS
	Cellular	Pwr Lvl: 0	SPEC ANL
Order	Amplitude	DVCC: 1	AUTHEN
Chng PL 0	-50.0 dBm	Voc: VSELP	DIG MEAS
MS Id	SID		More
Phone Num	231		
1111111111			

Con-mode.tif

Figure 23

CALL CONTROL Screen in Connect State

Choosing the proper combination of DVCC, slot, and channel number

The TIA/EIA specification indicates that on any single RF channel, the DVCC for all slots must be the same. For example, if your DCCH is assigned to channel 42, and you assign the mobile to a DTC of 42, then the DVCC for both the DCCH and the DTC must be the same.

TIA/EIA-136

Additionally, the specification requires that the DTC, if assigned on the same channel, be assigned to a different slot than the DCCH. The Test Set always assigns the DCCH to slots 1 and 4. If you assign your DTC to the same channel number, and assign the DTC to slot 1 or 4, the Test Set will remain in the Access state when you attempt to originate or handoff.

Select **Active** again to return the Test Set to the Active state. You must then change settings of the DVCC, slot, or channel numbers in order to prevent this from re-occurring.

What you should do:

- Don't use the same RF channel number for both DCCH and DTC.
- If you need to use the same RF channel number for both, then verify that the
 - slot number of the DTC \neq slot number of the DCCH (1 or 4), and
 - DVCC of the DTC = DVCC of the DCCH

Registration

See “Program Example” on page 149 for an example of the program command.

1. Verify that you have already done the following (refer to “Configure the Test Set to Emulate a Base Station” on page 64):
 - Zeroed the RF Power meter to your satisfaction.
 - Selected the proper audio filter, if you want to test audio.
 - Put the Test Set in Active state.
 - Connected the mobile to the Test Set and turned the mobile’s power on.
2. Select **Data** from the **Data/Meas** field. (This is the default mode)
3. Select **Register** from the list on the left side of the screen.
4. If the registration message has been received, the Test Set will display registration data in the upper half of the screen. See Figure 24 below.

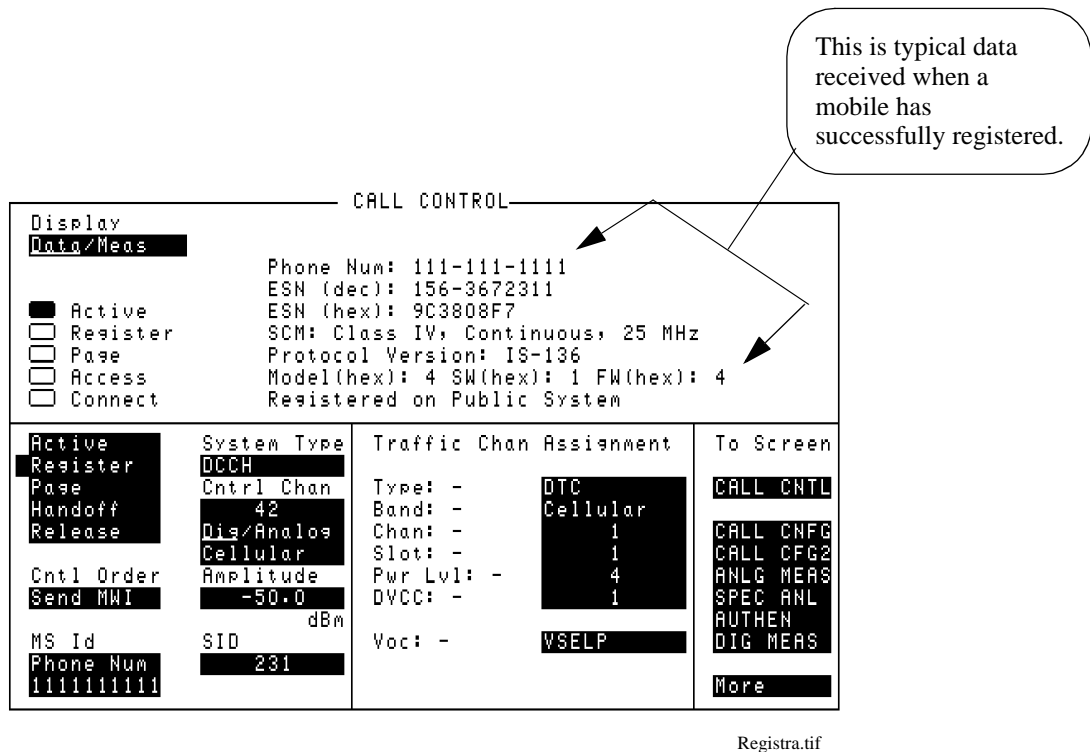

Figure 24

CALL CONTROL Screen with Registration Data Displayed

Chapter 3, Processing Calls Registration

***DATA DISPLAYED
WHEN ON AN ACC***

The last two lines of data (Protocol Version and Model) are not displayed when the Test Set is emulating a base station on an Analog Control Channel (ACC).

Release by Mobile

1. Verify that the Test Set is in the Connect state. (See [“Page” on page 91](#))
2. Press the END button on the mobile.
3. When the release is complete, you will see the Connect annunciator turn off, and the Active annunciator turn on.

Release by Test Set

See [“Program Example” on page 149](#) for an example of the program command.

1. Verify that the Test Set is in the Connect state (See [“Page” on page 91](#))
2. Select **Release** from the list on the left side of the screen.
3. When the release is complete, you will see the Connect annunciator turn off, and the Active annunciator turn on.

Short Message Services

Short Message Services (SMS) allow a short text message to be sent to the mobile. The mobile must either be camped on a DCCH or be connected on a DTC to receive the message. You can send a custom message or select all or part of a factory-defined message.

To Send a Short Message to the Mobile

The following procedure assumes that the Test System is configured to emulate a base station and the mobile is cabled to the Test System. See “[Configure the Test Set to Emulate a Base Station](#)” on page 64 if you are unsure of how to prepare the Test System.

1. Set the **Data/Meas** field on the **CALL CONTROL** screen to **Data**.
2. Register the mobile on a DCCH.
3. If desired, select **Page** to connect the mobile on a traffic channel.
4. Select **CALL CNFG** from the **To Screen** menu to access the **CALL CONFIGURE** screen.
5. Determine if you want to create a custom message or use the factory default message:

To send a custom message:

- a. Set the **Cust/Auto** field to **Cust**.
- b. Select the **SMS Contents** field and use the knob to create a message.

To send the factory default message:

- a. Set the **Cust/Auto** field to **Auto**.
6. Select the **SMS Size** field and enter the number of digits from the message that you want to send. For example, you may only want to send 50 of the possible 243 characters.
7. Select **CALL CNTL** from the **To Screen** menu to return to the **CALL CONTROL** screen.
8. Select the **Cntl Order** or **Order** field and choose **Send SMS**. The **Access** annunciator lights as the Test System sends the message. If the short message was correctly received by the mobile, the message **SMS Successful** is displayed.

Chapter 3, Processing Calls

Short Message Services

DCCH CALL CONFIGURE

DCCH DVCC 128	Country Code 310	SMS Contents
Sat Tol Narrow	Access Burst Nrm/Abbrev	
Power Meter Zero	DTC Burst Nrm/Shorten	SMS Type SMS Size Cust/Auto 50
RF Path Bypass/IQ	Dis Signal Std/NonStd	Public Sys On/Off
% BIT ERROR 0.00 %	Reg Conf Off/On	# Systems SOC 0 0
# Neighbors 0		To Screen CALL CNTL CALL CNFG CALL CFG2 ANLG MEAS SPEC ANL AUTHEN DIG MEAS More

Use these three fields to define the SMS message.

dccch_cc.tif

CALL CONTROL

Display
Data/Meas

SMS Successful:
MS Indicates RDATA Accepted

Indication that the mobile has successfully received and decoded the SMS message.

Select **Send SMS** to send the SMS message (the name of this field is changed to **Order** if the mobile is connected on a call).

<input type="checkbox"/> Active	System Type DCCH	Traffic Chan Assignment	To Screen
<input type="checkbox"/> Register	Cntrl Chan 42	Type: DTC DTC	CALL CNTL
<input type="checkbox"/> Page	Dig/Analog Cellular	Band: Std Cellular	CALL CNFG
<input type="checkbox"/> Access	Amplitude -50.0	Chan: 1 1	CALL CFG2
<input checked="" type="checkbox"/> Connect	dBm	Slot: 1 1	ANLG MEAS
Order		Pwr Lvl: 4 4	SPEC ANL
Send SMS		DVCC: 1 1	AUTHEN
MS Id	SID	Voc: VSELP	DIG MEAS
Phone Num 1111111111	231	VSELP	More

call_cnf_sms.tif

Making Measurements

This chapter discusses the difference between data and measurements. It also explains how to read data and make measurements.

How to Read Data and Make Measurements

Most measurements are made directly by toggling the **Data/Meas** field. Measurements are available in both the CALL CONTROL screen and the DIGITAL MEASUREMENT screen. BER is only available in the DIGITAL MEASUREMENT screen. MAHO is only available in the CALL CONTROL screen. Some measurements, such as BER and Average Power, have special conditions that must be met before the measurement is accurate. These measurements are described in detail later in this chapter.

The Difference Between Data and Measurements

Data is the contents of messages transmitted or received by the mobile or Test Set. Data usually has no units associated with it. Some data is listed below.

Data

- phone number
- ESN
- SCM

Measurements are evaluations of the Device Under Test (DUT). Measurements typically have units associated with them. Some measurements are listed below.

Measurements

- EVM1 (%)
- adjacent channel power (dB)
- BER (%)
- Average Power (requires HP 8920B Option 006 or PCS Interface)
- TX Power

How to Switch Between Data and Meas Mode

To switch between Data and Meas mode, select the **Data/Meas** field. This toggles between data and measurement modes.

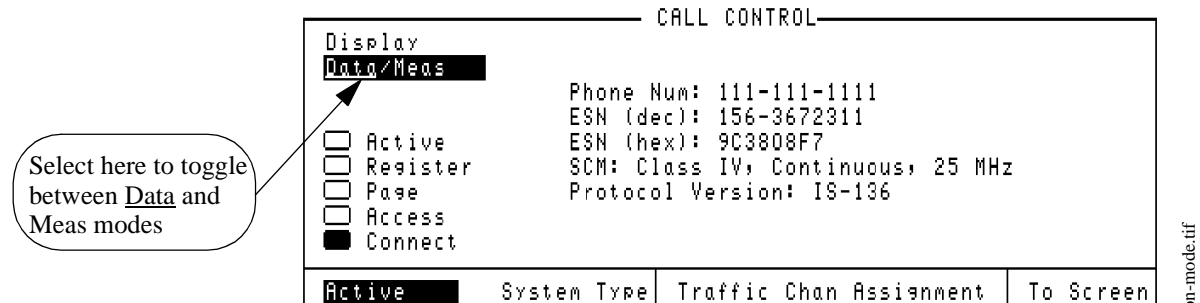

Figure 25

Switching Between Data and Measurements

Data Displayed

The data that is displayed when a mobile responds depends on the mobile's status with respect to the Test Set.

The data area is blank when the Test Set has not communicated with the mobile.

The data area contains Phone, ESN (decimal), ESN (hex), and SCM after the mobile has actively communicated with the Test Set. It also displays Protocol version, Model Number, Software Vintage, and Firmware Vintage of the mobile.

The data area displays the mobile's response to a Change Power Level order.

The data area displays the hexadecimal values of the data received when an error has occurred in the data received.

The data displays the number called when the mobile originates a call.

Connect State & Mobile Test Mode

There are two methods of making measurements with the DCCH Call Processing subsystem. Each method requires that the mobile be in a certain state, and each method uses a different screen.

One method requires that the Test Set be in “Connect” state with the mobile. This state uses the Test Set to act as a base station, transmitting the necessary protocol to the mobile to allow it to get a call up for making measurements. It uses the CALL CONTROL screen to display measurements for both DTC and AVC signals.

The second method, “Test” mode, requires that the mobile be in the test mode as per the TIA/EIA specification IS-137. This mode allows the mobile to transmit without receiving protocol transmitted from the Test Set. It uses the DIGITAL MEASUREMENT (DIG MEAS) screen to display measurements.

Connect State Measurements

When the Test Set is in the Connect state, different groups of measurements that can be displayed at one time: EVM1, EVM10, Adjacent Channel Power, Average Power and MAHO. You can choose which group you want to have displayed by selecting the field below the **Data/Meas** field. An overview of the different measurement sets is shown in [Figure 27 on page 103](#).

BER measurements can only be made when the Test Set is in the DIGITAL MEASUREMENT screen.

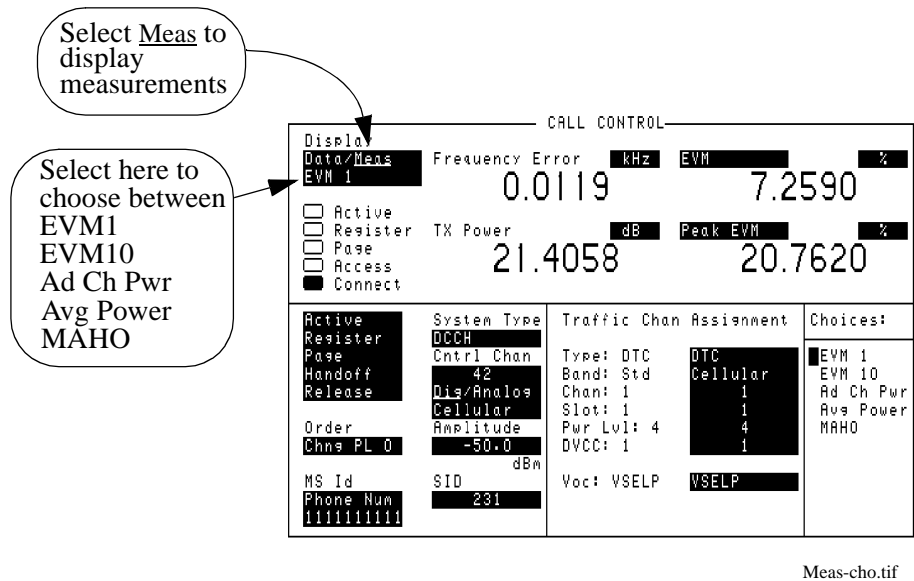

Figure 26 The Measurements Display (CALL CONTROL Screen)

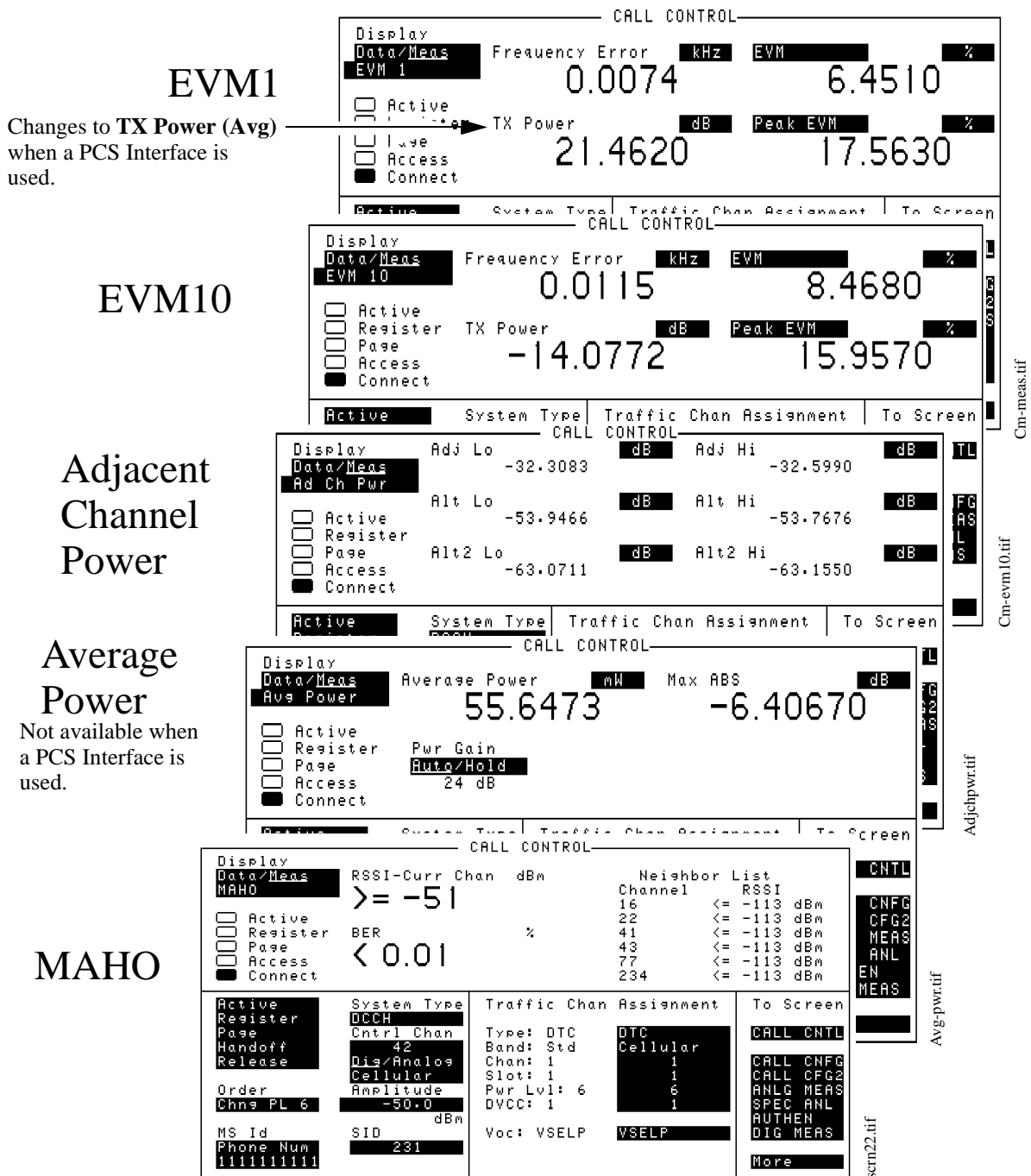

Figure 27

Connect State Measurements Available on a Digital Traffic Channel

Chapter 4, Making Measurements
How to Read Data and Make Measurements

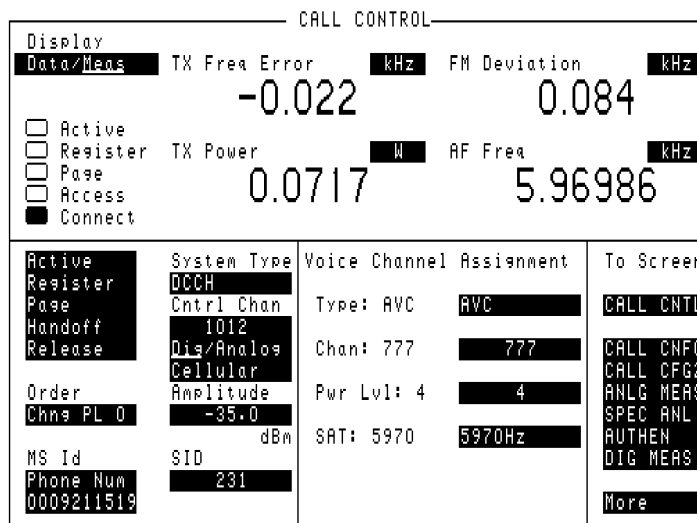

Figure 28 Connect State Measurements Available on a Analog Voice Channel

**Test Mode
 Measurements**

When the Test Set is in either the Connect state or the Active state, the DIGITAL MEASUREMENT screen can be used to make measurements on a DTC. The ANALOG MEASUREMENT screen can be used to make measurements on an AVC. For the DIGITAL MEASUREMENT screen, the measurements that can be made are almost the same for the Connect state measurements. The exception is that instead of MAHO, BER can be measured in this screen.

Notice that ACCH is at the list of measurement choices. This function is only used under HP-IB operation. See “Dig Meas” on page 230

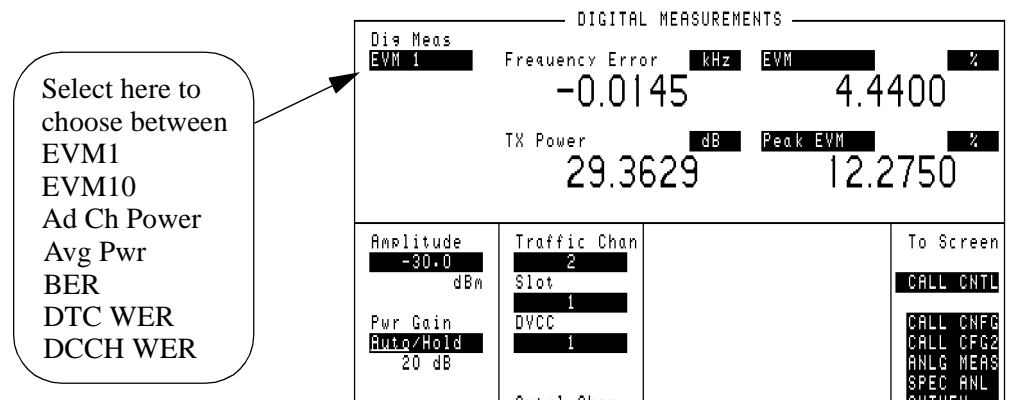

Figure 29 The Digital Measurement Display

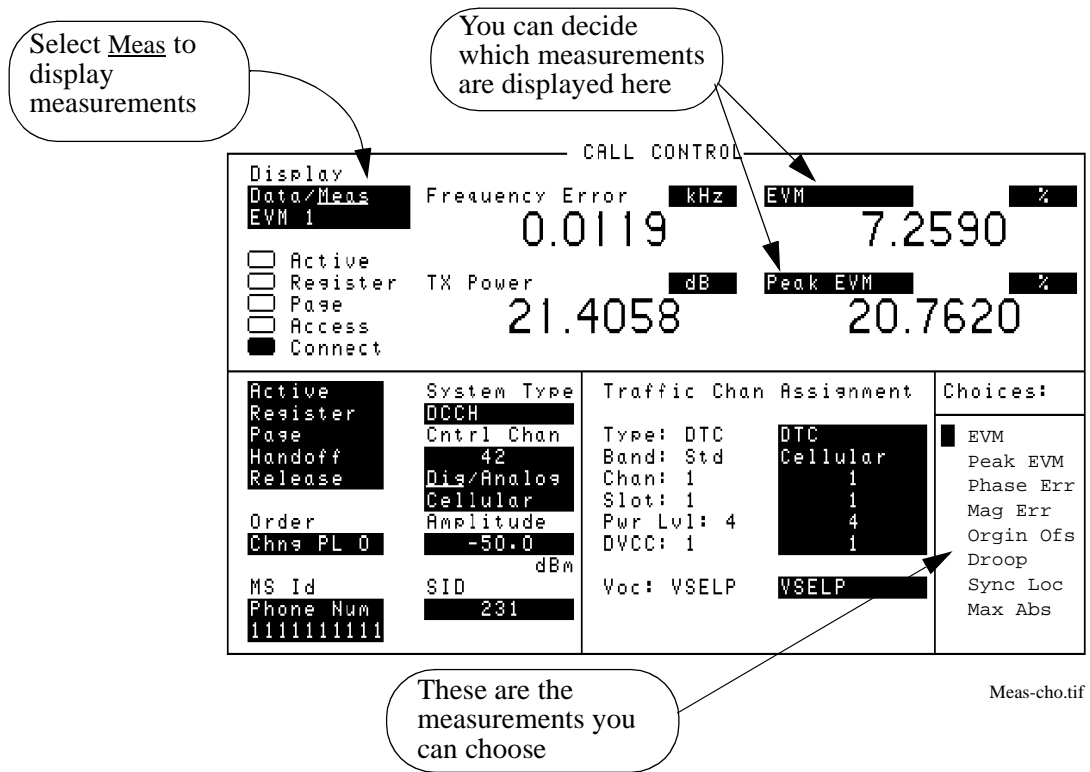
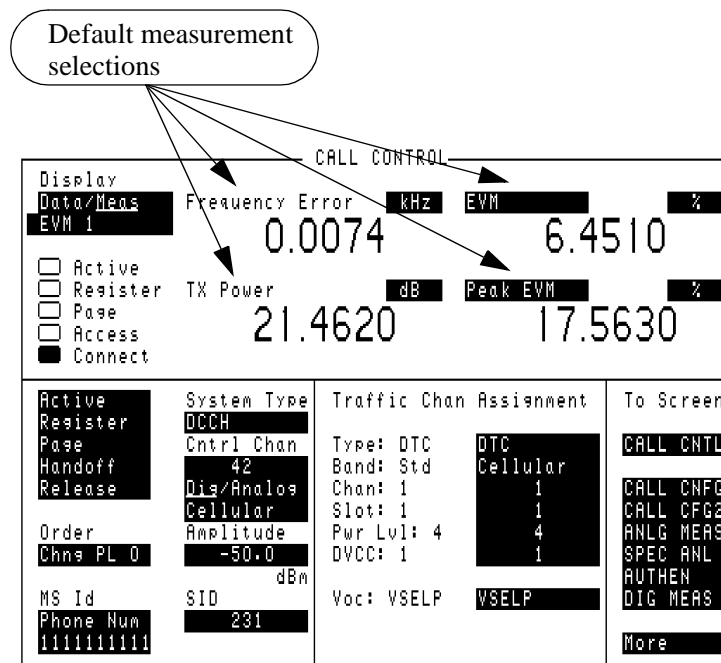

Figure 30 The Default Measurements Screen

Making changes to the Measurements display

In the Connect state, when Meas is selected for the first time, the default screen displays the EVM1 measurements. When making measurements on a digital traffic channel, there are four default selections for the EVM1 measurements:

- Frequency Error
- TX Power
- EVM
- Peak EVM



Cm-meas.tif

Figure 31

Default Measurement Selections

The Meas display for EVM 1 and EVM 10 can be configured to display different measurements. If it has already been modified, the last modified display will appear instead of the default. The displays for Adjacent Channel Power, Average Power, and MAHO are fixed.

CALL PROCESSING DURING MEAS MODE

If you select any of the call processing functions (**Active, Register, Page, Handoff, Release**) while in the Meas mode, the display will automatically change back to the Data mode.

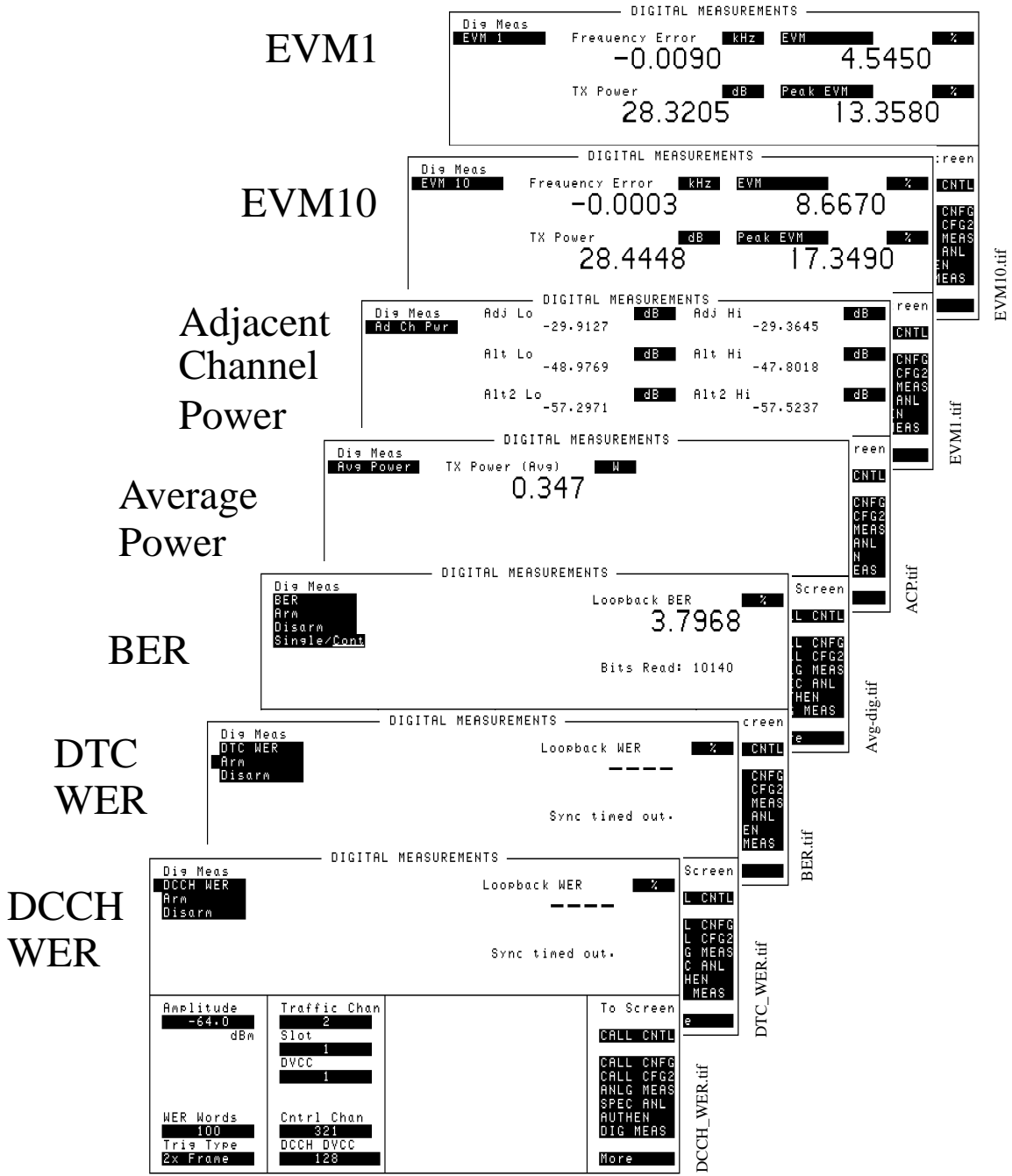

Figure 32 Test Mode Measurements Available (DIGITAL MEASUREMENT Screen)

Other changes you can make There are two other types of changes you can make to the Meas display:

1. the actual measurements displayed
2. the units of each measurement displayed

Changing the measurements displayed

When Meas is selected from the Data/Meas field, a new field appears under the Data/Meas field. The default is EVM1, and when selected, a list of choices appears. The list of choices allows more measurements such as EVM 10, Adjacent Channel Power, Average Power, and MAHO. EVM1 and EVM10 displays look similar. Each of the other measurements has a display tailored to its requirements.

To change between these screens, select any measurement from the list of choices.

The EVM1 and EVM10 screens have one more level of display capability. The two fields at the right of the screen can display any of the measurements from a new list of choices. Select either of these fields in order to show the list of choices. Then select the measurement to be displayed.

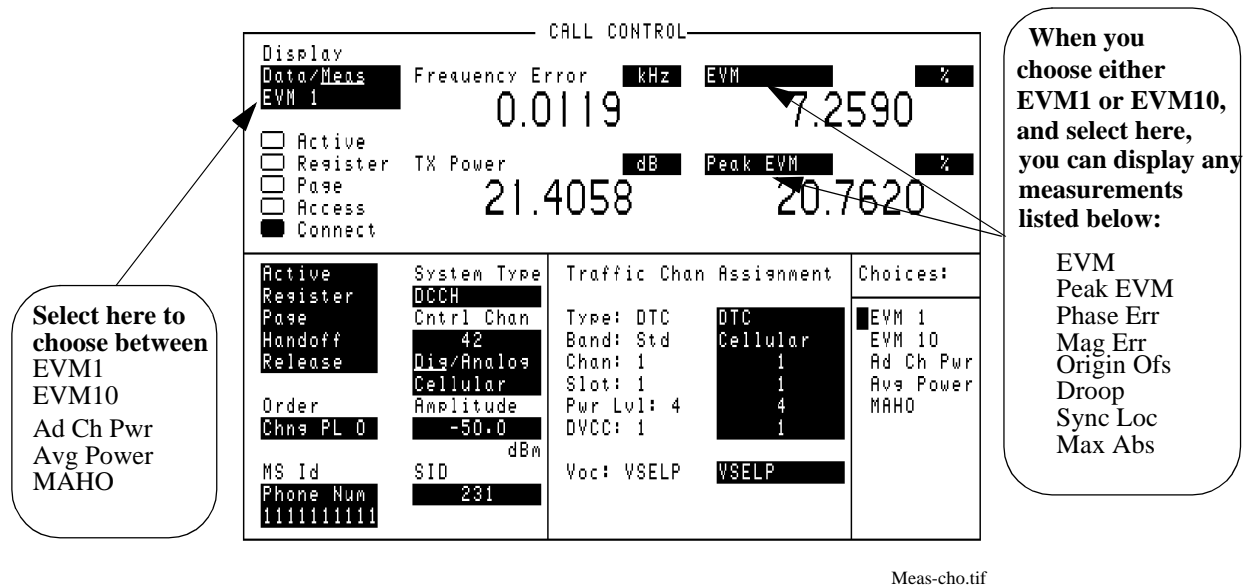
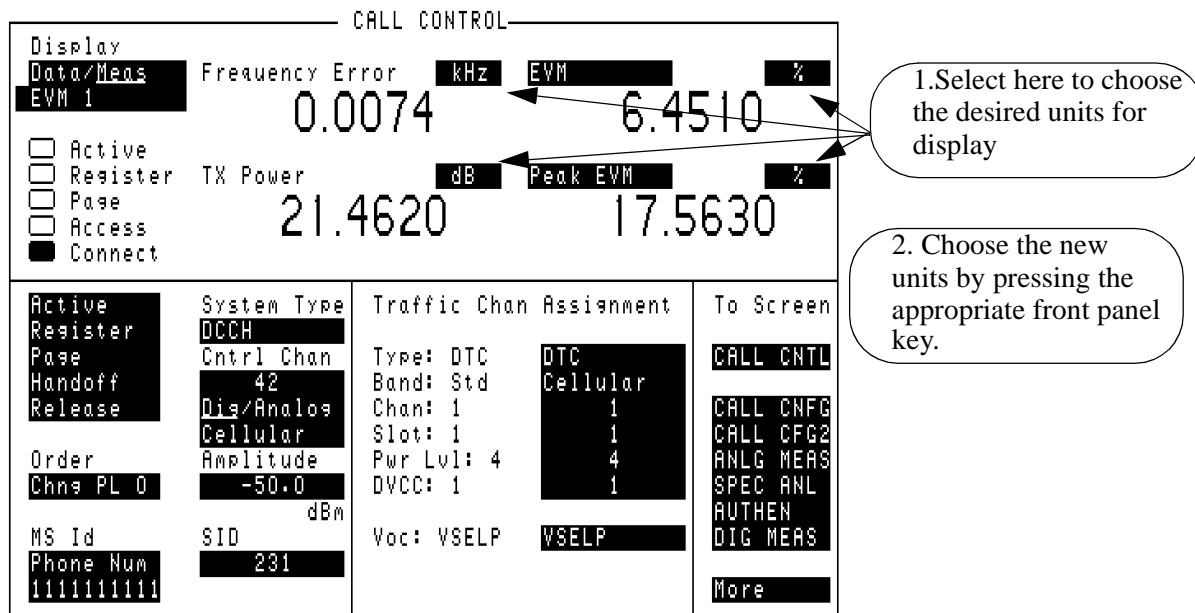

Figure 33 Choosing Measurements to Display

Changing the units displayed

The unit for a measurement is displayed to the right of the measurement name in the data display area. To change the unit, select the unit field, and then press the desired unit key on the front panel.



Cm-meas.tif

Figure 34 Changing Measurement Display Units

How to determine if a call is dropped There are several methods for using the Test Set to determine if a call has been dropped. Any of the following situations may occur.

Connect state ends

If the Connect annunciator goes off, and the Test Set returns to the Active state, the call has dropped or ended.

DTC is not detected

If communication fails on the Reverse DTC, a message will appear at the top of the screen: “No Reverse DTC is being detected, loss of Traffic Channel.” The Test Set will return to Active state.

Analog connection ends

If communication fails on the AVC, a message will appear at the top of the screen: “RF Power Loss indicates loss of Voice Channel.” The Test Set will return to Active state. If the **Display** field is set to Meas, the message “Analyzer is underdriven. Increase signal level or gain.” is displayed.

Adjacent Channel Power

Adjacent Channel Power is measured in either Connect state or test mode. The measurement procedure described below is for the Connect state. To measure in the test mode, see “[Test mode measurement procedure](#)” on page 118.

Adjacent Channel Power measures the power on six adjacent channels. These are the three nearest channels both below and above the designated channel.

Adjacent Channel Power is measured on each adjacent channel relative to the current channel.

Adjacent Channel Power measurement procedure

1. Make sure the Test Set is in Connect state. See “[Registration](#)” on page 93.
2. Select **Meas** from the **Data/Meas** field.
3. A field appears below the **Data/Meas** field. Select this field.
4. Select **Adj Ch Pwr** from the list of choices. The Adjacent Channel Power will be displayed. This measurement can take several seconds to complete.

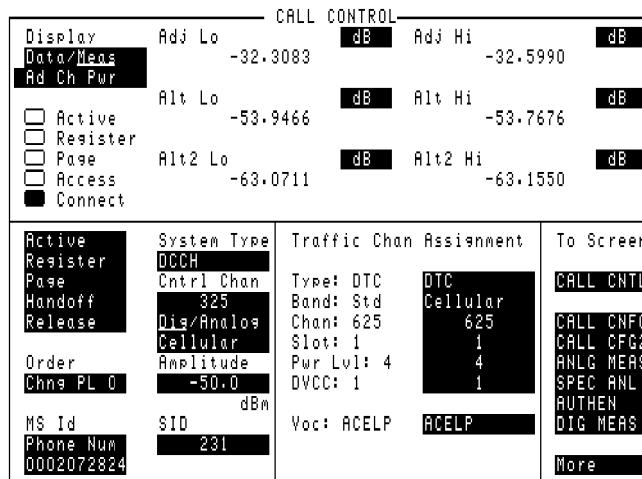

adjchpwr.tif

Figure 35 Adjacent Channel Power Display

Analog Parameters

Analog parameters are measured in either Connect state or test mode. The measurement procedure described below is for the Connect mode. To measure in the test mode, select the **ANLG MEAS** screen.

You can measure parameters of a TIA/EIA-136 mobile on its Analog Voice Channel (AVC). For measurements on this analog channel, use the following procedure.

The Test Set must be active on an AVC. If your mobile is active on a DTC, you must first either Originate, Page, or Handoff to an AVC.

1. Make sure the Test Set is in Connect state on an AVC. See “Registration” on page 93.
2. Select **Meas** from the **Data/Meas** field.
3. The analog measurements should be displayed.

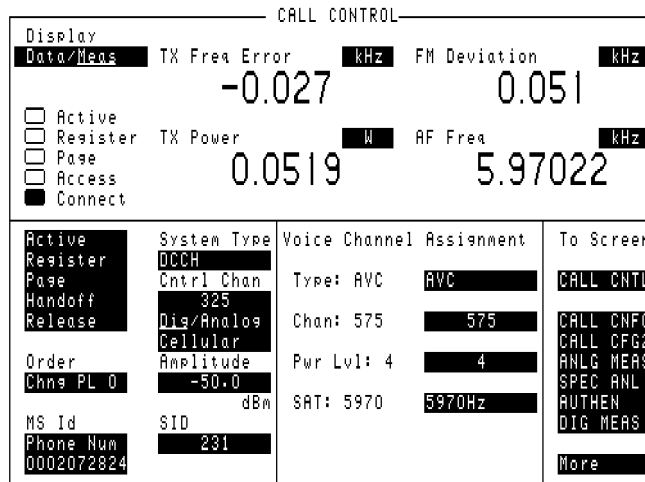

Scrn27.tif

Figure 36

Analog Measurements Display

Average Power

Average Power measures *absolute* transmitter power on a digital traffic channel (DTC), and requires the use of the special average power detector that is only available with Test Set Option 006 (50 μ W to 10W Power Measurement Range). Average Power measurements are limited to this power range. Refer to [“Power Measurements” on page 130](#) for more information.

BER

Loopback BER can only be measured while the Test Set is in Active mode, and the mobile is in its test mode. This measurement is for raw BER, measured on a traffic channel.

Each mobile manufacturer has their own method of enabling the test mode for their phones. Those methods will not be discussed here.

BER Measurement Procedure

1. Make sure the Test Set is in Active mode.
2. Select **DIG MEAS** from the **To Screen** menu.
3. Select the **Dig Meas** field to display a list of available tests.
4. Select **BER** from the list.
5. Enter the number of bits to be measured in the **BER Bits** field. (Note: the number of bits actually read will be calculated in whole frames.)
6. Put the mobile into its test mode.
7. Select **Arm**.
8. After the actual number of bits has been transmitted and received, the BER should be displayed.

If your tests require that you measure BER with a known inserted bit error rate, use the procedure, [“BER Measurement with Inserted Bit Errors”](#) on page 116.

BER Measurement with Inserted Bit Errors

1. Make sure the Test Set is in Active mode.
2. Select **CALL CNFG** from the **To Screen** menu.
3. Assign a global USER key to the % BIT ERROR field as follows:
 - a Select the % **BIT ERROR** field.
 - b Press the SHIFT key, then k4 (ASSIGN) key.
 - c Press the SHIFT key again, then the k1 key.
4. Select **DIG MEAS** from the **To Screen** menu.
5. Select the **Dig Meas** field to display a list of available tests.
6. Select **BER** from the list.
7. Set the **Single/Cont** field to **Cont** (continuous).
8. Enter the number of bits to be measured in the **BER Bits** field. (Note: the number of bits actually read will be calculated in whole frames.)
9. Set the **Amplitude** field to **-50 dBm**.
10. Put the mobile in loopback mode.
11. After the actual number of bits has been transmitted and received, the BER should be displayed. The BER should be 0% at **-50 dBm**.
12. Press the SHIFT key then the k1 key. The **Inserted DTC Bit Error Rate** field should be displayed at the top of the screen.
13. Enter a value between 0.00% and 20.00% in the **Inserted DTC Bit Error Rate** field. The Loopback BER measurement should return the value that you entered in this field. If this measurement is slightly off, increase the number of BER bits to 50,000 or more.

How the Test Set measures raw BER

BER is measured in the DIGITAL MEASUREMENT screen.

When the Test Set is in Active state (the Active annunciator is on), the Test Set is emulating a base station, but is not communicating with a mobile.

The mobile must be in loopback mode. That way, the Test Set receives the data without the data being decoded by the mobile.

Selecting Dig Meas while in Active state signals the Test Set to bring up a traffic channel. The data is then transmitted and received over that channel.

When you enter the BER Bits number, you are selecting the desired maximum number of bits to be transmitted. The actual number of bits transmitted is a multiple of 260 bits. The data is transmitted in a whole number of frames. One frame has 260 bits. For example, if you select 10000 bits to be transmitted, the actual number of bits transmitted is 10140 (10140 bits / 260 bits per frame = 39 frames).

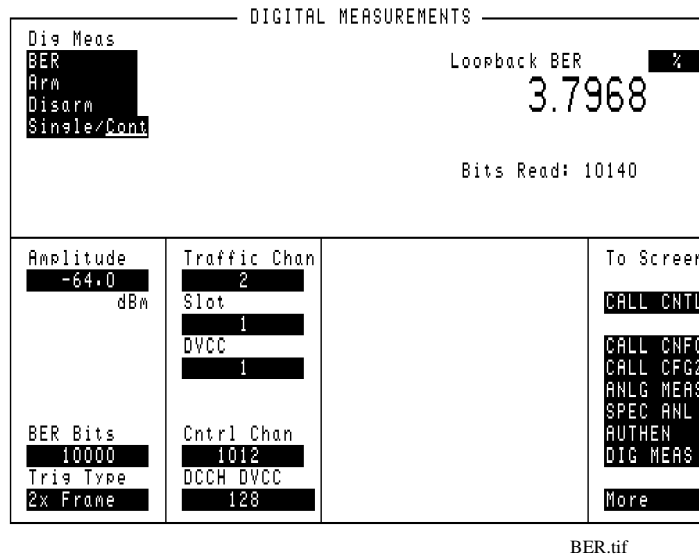

Figure 37 BER Display Indicating a Mobile with a High BER for the Specified Amplitude

Digital Measurement Screen Tests

This screen allows you to test the DTC without requiring that the mobile and the Test Set be in the Connect state. This is achieved by utilizing the Mobile Station Test Interface as described in the TIA/EIA Interim specification IS-137.

Basically, you start with the Test Set in Active state, display the DIGITAL MEASUREMENT screen, put your mobile into its IS-137 test mode, and test as usual.

Test mode measurement procedure

1. Make sure the Test Set is in Active mode.
2. Select **DIG MEAS** from the **To Screen**.
3. Select the **Meas** field. This shows the **To Screen** with a list of available tests.
4. Select your desired test from the To Screen.
5. Put the mobile into its test mode.
6. Make measurements as described in the individual measurement procedures.

DIGITAL MEASUREMENT SCREEN CAN ALSO DISPLAY CONNECT STATE MEASUREMENTS

This screen is the only screen in which you can make test mode measurements as per IS-137. However, it also allows measurements that are made in Connect mode.

To use this screen while in Connect state, select the **DIG MEAS** screen. All of the measurements will be available.

Note that you will not know if the call gets dropped while using this screen. You must return to the **CALL CONTROL** screen to determine the status of the call.

Note that if you change the **Traffic Channel number** field in the DIGITAL MEASUREMENT screen, the **RF Gen Frequency** field in the DUPLEX screen changes corresponding to the new channel number. However, if you change the **RF Gen Frequency** field in the DUPLEX screen, the Traffic Channel number does not change.

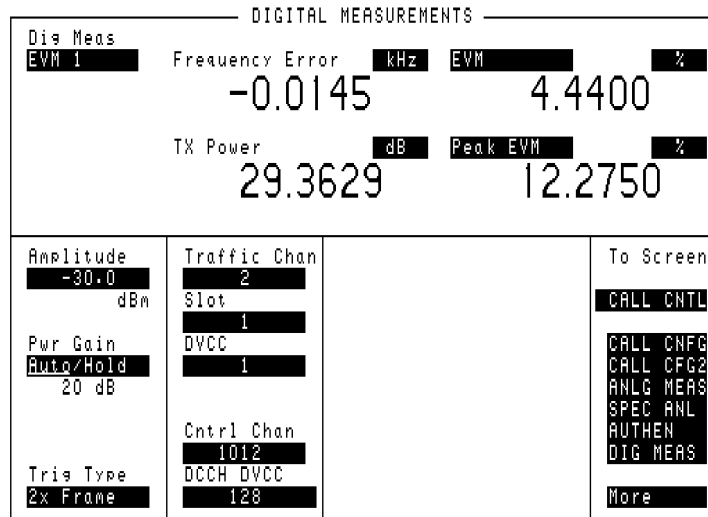

dig-meas.tif

Figure 38

DIGITAL MEASUREMENT Screen Display

Droop

Droop is measured in either Connect state or test mode. The measurement procedure described below is for the Connect state. To measure in the test mode, see “[Test mode measurement procedure](#)” on page 118.

Droop measures the difference between the level of the first symbol and the level of the last symbol captured by the analyzer.

Droop measurement procedure

1. Make sure the Test Set is in Connect state. See “[Registration](#)” on page 93.
2. Select **Meas** from the **Data/Meas** field.
3. Select one of the two measurement fields that can be modified.
4. Select **Droop** from the list of choices. The droop measurement will be displayed.

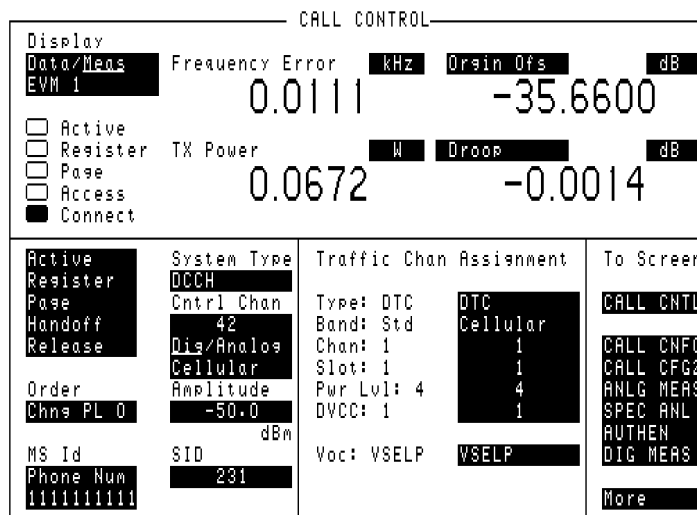

Con-00dp.tif

Figure 39

Droop Display

EVM

EVM is measured in either Connect state or test mode. The measurement procedure described below is for the Connect state. To measure in the test mode, see “[Test mode measurement procedure](#)” on page 118.

Error Vector Magnitude (EVM) measures the magnitude (rms) of the error vector between the measured and the ideal signal. EVM 1 measures over one burst. EVM 10 is the first 10 symbols of 10 bursts, averaged. Peak EVM is the peak value measured over the burst.

The procedure below describes the measurement for EVM 1. EVM 10 is listed below EVM 1 in the list of choices.

EVM measurement procedure

1. Make sure the Test Set is in Connect state. See “[Registration](#)” on page 93.
2. Select **Meas** from the **Data/Meas** field.
3. EVM 1 is displayed as default. If EVM is not displayed, continue with the next step.
4. A field appears below the **Data/Meas** field. Select this field.
5. Select **EVM 1** from the list of choices. The measurement will display.

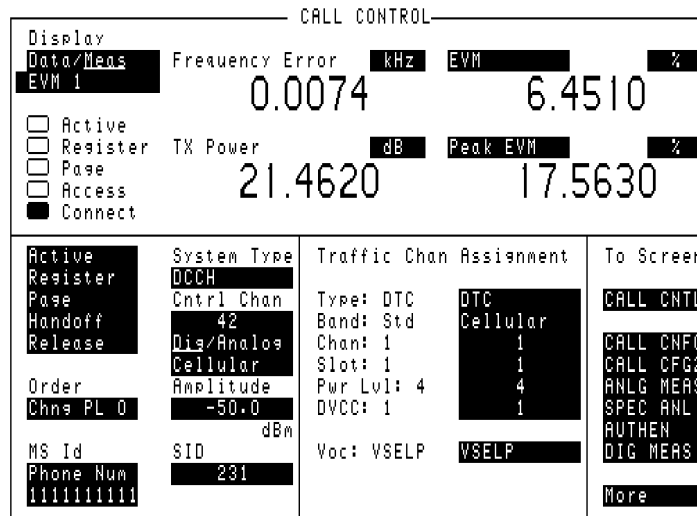

Cm-meas.tif

Figure 40

EVM Display

Frequency Error

Frequency error is measured in either Connect state or test mode. The measurement procedure described below is for the Connect mode. To measure in the test mode, see “[Test mode measurement procedure](#)” on page 118.

TX frequency error measures the difference between the measured frequency and the frequency that the Test Set is tuned to.

TX frequency error measurement procedure

1. Make sure the Test Set is in Connect state. See “[Registration](#)” on page 93.
2. Select **Meas** from the **Data/Meas** field.
3. Freq error is displayed.

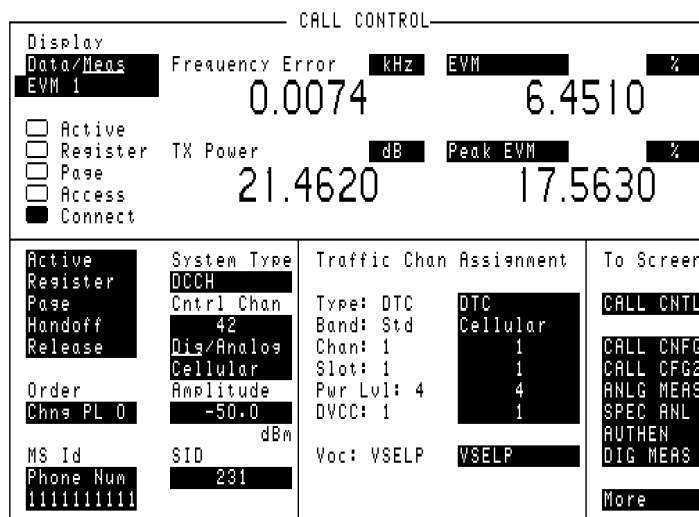

Cm-meas.tif

Figure 41 Frequency Error Display

Magnitude Error

Magnitude error is measured in either Connect state or test mode. The measurement procedure described below is for the Connect state. To measure in the test mode, see “[Test mode measurement procedure](#)” on page 118.

Magnitude error is the difference in amplitude at the detector point between the measured value and the ideal value.

This is an indicator of the quality of the signals’ amplitude. For example, a high magnitude error may indicate significant AM on the signal. This value is one of the components of EVM.

Magnitude error measurement procedure

1. Make sure the Test Set is in Connect state. See “[Registration](#)” on page 93.
2. Select **Meas** from the **Data/Meas** field.
3. Select one of the two measurement fields that can be modified.
4. Select **Mag Err** from the list of choices. The Magnitude error measurement will be displayed.

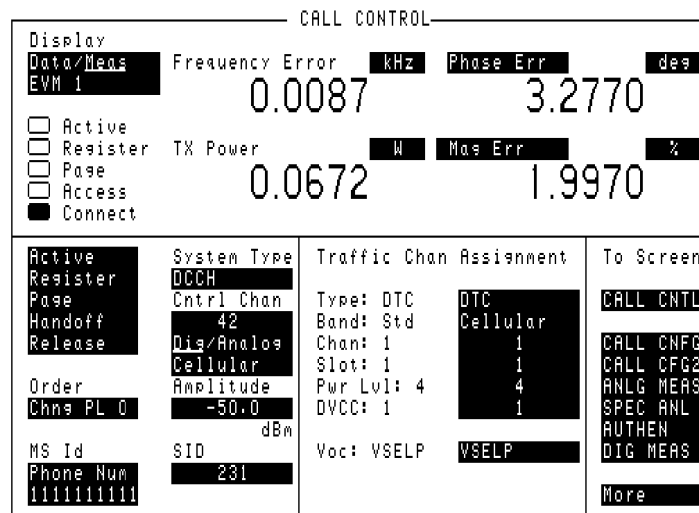

Con-phma.tif

Figure 42

Magnitude Error Display

MAHO

This measurement is available only from the CALL CONTROL screen in Connect state.

MAHO (Mobile Assisted HandOff) is actually a measurement, not a handoff. The reported results are used by a base station to select the channel for the handoff.

The mobile performs the measurements, and then reports the results back to the base station. The mobile measures the RSSI of neighboring channels, as instructed by the base station. It also measures and reports the RSSI and BER of the current channel.

You can select the number of neighbor channels from the CALL CNFG screen. You can also set up several parameters of the MAHO in the same screen.

Follow the procedure, [“Setting up the MAHO measurement” on page 125](#). Then make the measurement using the [“Measuring MAHO” on page 126](#), or [“Measuring MAHO BER with Inserted Bit Errors” on page 127](#) procedure.

Setting up the MAHO measurement

1. Select **CALL CNFG** from the CALL CONTROL's **To Screen**.
2. Set the number of neighbors (up to 6) with the field **# Neighbors**.
3. **Neighbor List Channel** fields appear below the **# Neighbors** field.
4. Set the channel number of each neighbor channel.

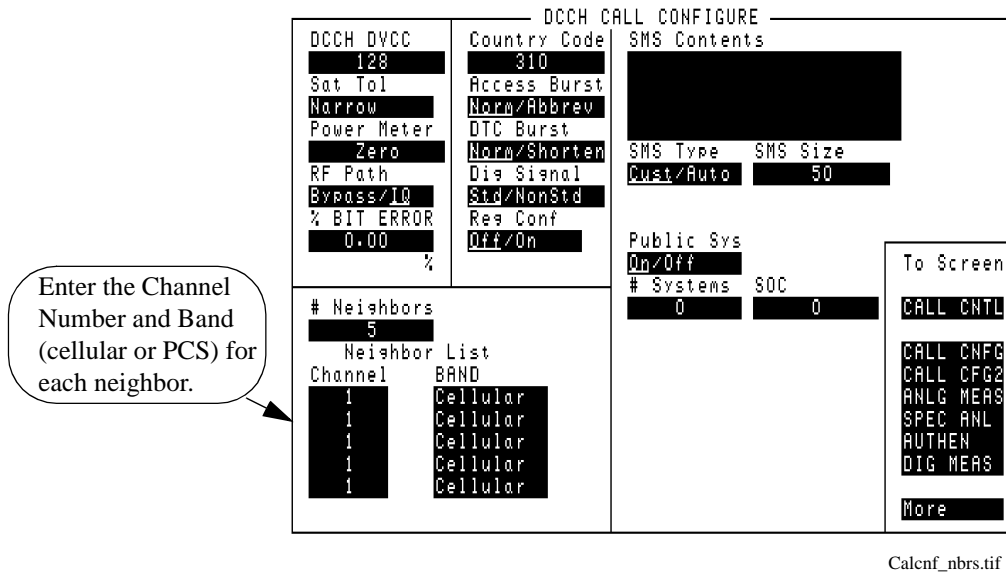
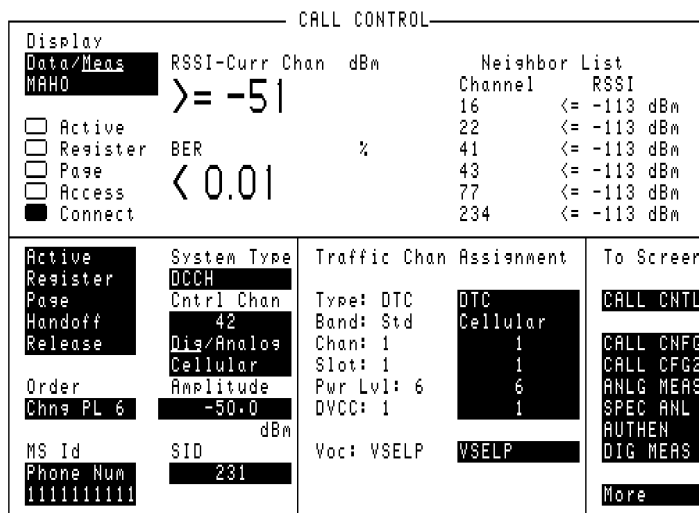

Figure 43 MAHO Setup

Measuring MAHO

1. From CALL CONTROL screen, set up a call (Test Set must be in Connect mode).
2. Select **Meas** from the **Data/Meas** field.
3. Select the field that has appeared below **Data/Meas**.
4. Select **MAHO** from the list of choices.
5. The RSSI and BER of the current channel are reported, as well as the RSSI of the designated neighbor channels.



scrn22.tif

Figure 44

MAHO Results

If your tests require that you measure MAHO BER with a known inserted bit error rate, use the procedure, [“Measuring MAHO BER with Inserted Bit Errors”](#) on page 127.

Measuring MAHO BER with Inserted Bit Errors

1. Select the CALL CONTROL screen.
2. Set the **Amplitude** field to -50 dBm.
3. Allow the mobile to camp on the DCCH.
4. Bring up a call on a DTC, either by paging or origination.
5. Select **CALL CNFG** from the **To Screen** menu.
6. Assign a global USER key to the % BIT ERROR field as follows:
 - a. Select the % **BIT ERROR** field.
 - b. Press the SHIFT key, then k4 (ASSIGN) key.
 - c. Press the SHIFT key again, then the k1 key.
7. Go to the CALL CONTROL screen.
8. Select **Meas** from the **Data/Meas** field.
9. Select the field that appears below **Data/Meas**.
10. Select **MAHO** from the list of choices.
11. After the actual number of bits has been transmitted and received, the BER should be displayed. The MAHO BER should be <0.01.
12. Press the SHIFT key then the k1 key. The **Inserted DTC Bit Error Rate** field should be displayed at the top of the screen.
13. Enter a value between 0.00% and 20.00% in the **Inserted DTC Bit Error Rate** field. The MAHO BER measurement results should change. For example, if you enter 2.35%, the MAHO BER should return $2.0 < 4.0$. If you enter 0.10%, the result should alternate between $0.01 < 0.1$ and $0.1 < 0.5$.

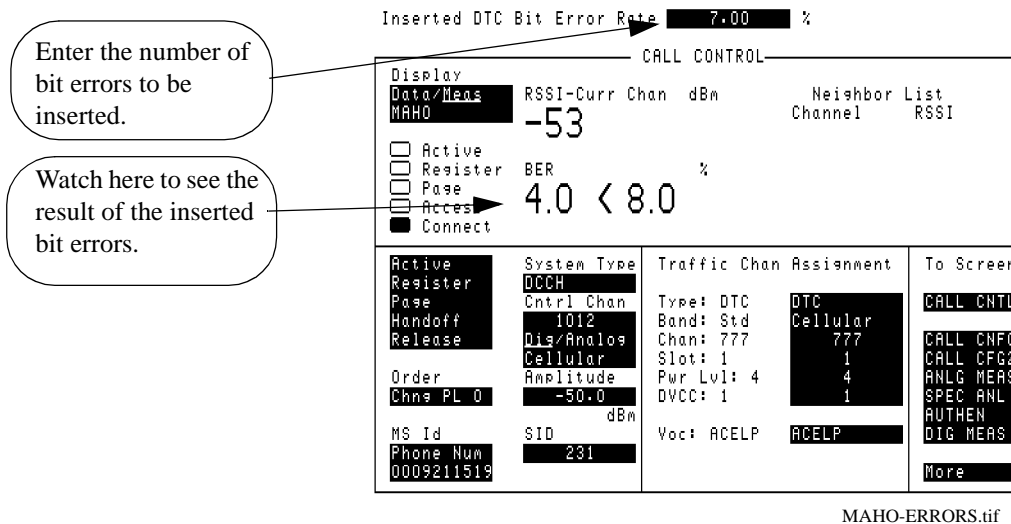

Figure 45

Maho Measurement with Inserted Bit Errors

Origin Offset

Origin offset is measured in either Connect state or test mode. The measurement procedure described below is for the Connect state. To measure in the test mode, see “[Test mode measurement procedure](#)” on page 118.

Origin offset measures the magnitude of the RF carrier leakage relative to the magnitude of the modulated carrier at the detection point.

Origin Offset measurement procedure

1. Make sure the Test Set is in Connect state. See “[Registration](#)” on page 93.
2. Select **Meas** from the **Data/Meas** field.
3. Select one of the two measurement fields that can be modified.
4. Select **Origin Ofs** from the list of choices. The Origin Offset measurement will be displayed.

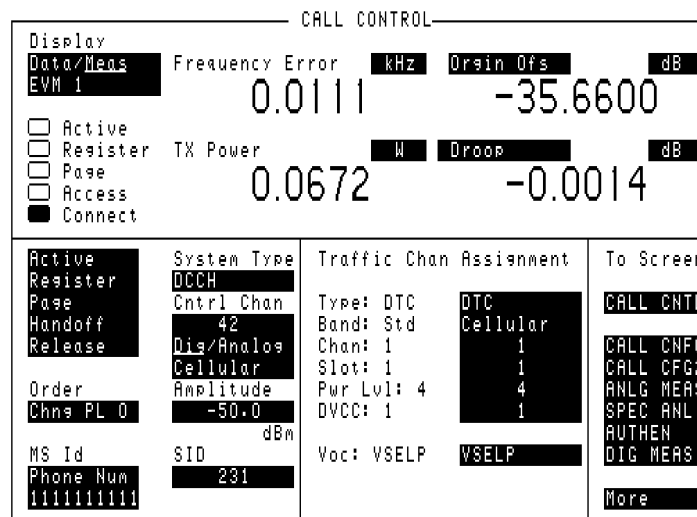

Con-00dp.tif

Figure 46 Origin Offset Display

Phase Error

Phase error is measured in either Connect state or test mode. The measurement procedure described below is for the Connect state. To measure in the test mode, see “[Test mode measurement procedure](#)” on page 118.

Phase error is the difference in phase at the detection point between the received signal and an ideal signal.

Phase Error measurement procedure

1. Make sure the Test Set is in Connect state. See “[Registration](#)” on page 93.
2. Select **Meas** from the **Data/Meas** field.
3. Select one of the two measurement fields that can be modified.
4. Select **Phase Err** from the list of choices. The Phase Error measurement will be displayed.

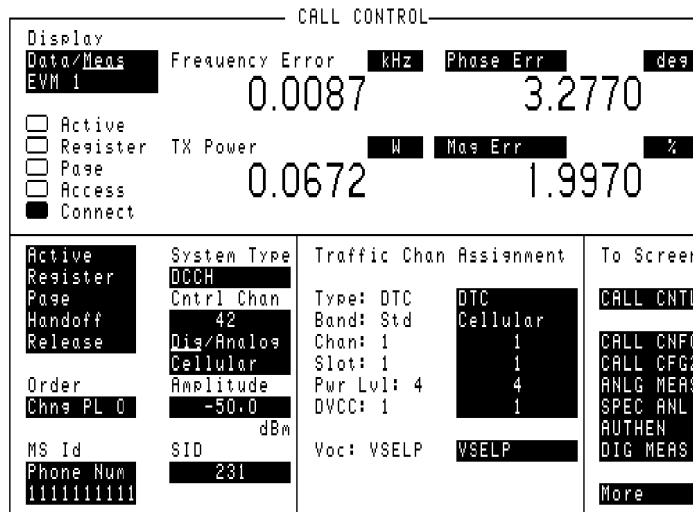

Con-phma.tif

Figure 47

Phase Error Display

Power Measurements

Transmitter power is measured when the Test Set is in the Connect state (the **Connect** annunciator is “lit” on the CALL CONTROL screen), or when the mobile is in its Test mode. Test Mode power measurements cannot be made on the CALL CONTROL screen, but can be made on the DIGITAL MEASUREMENTS, ANALOG MEAS, DUPLEX TEST, and RF ANALYZER screens.

The mobile’s transmitted RF power can be measured and displayed several ways. The power measurement type and method you use depends on several factors, including:

- The presence of a PCS Interface in your Test System.
- The presence of Option 006 in your Test Set.
- The level of the signal you are measuring.
- The availability of a “reference” signal: an RF carrier at a known signal level, and at the same frequency of the signal to be measured.
- The type of voice or traffic channel you are measuring: DTC or AVC

Power Measurements Descriptions

The following descriptions explain the types of power measurements that are available and when to use each of them. Table 3 indicates which power measurements are available on which screens for the different hardware configurations.

Table 3 Test Set Screens from which Average Power and TX Power of the DTC and AVC can be Measured

Power Measurement Type	With HP 83236B		Without HP 83236B	
	DTC	AVC	DTC	AVC
TX Power (Avg) and Average Power (Watts) Absolute	Screens: <ul style="list-style-type: none"> • Call Control • Analog Meas • Duplex Test • RF Analyzer 	Screens: <ul style="list-style-type: none"> • Call Control • Analog Meas • Duplex Test • RF Analyzer 	Screens:¹ <ul style="list-style-type: none"> • Call Control 	Screens: <ul style="list-style-type: none"> • RF Analyzer • Duplex Test • Analog Meas • Call Control • Digital Measurements
TX Power (Watts) Absolute				Screens: <ul style="list-style-type: none"> • Analog Meas • RF Analyzer • Duplex Test
TX Power (dB) Relative	Screens: <ul style="list-style-type: none"> • Digital Measurements 	Screens: <ul style="list-style-type: none"> • Digital Measurements 	Screens: <ul style="list-style-type: none"> • Call Control • Digital Measurements 	Screens: <ul style="list-style-type: none"> • Digital Measurements

1. Average power measurements on a DTC require Test Set Option 006 if a PCS Interface is not used.

TX Power [dB]

This is a relative measurement; measured in dB (not dBm or W). This is the only DTC power measurement available if your Test Set is not equipped with Option 006 and you are not using a PCS Interface. This is one of the measurements displayed when EVM1 or EVM10 is measured on the CALL CONTROL or DIGITAL MEASUREMENTS screens.

***CALIBRATING THE
RELATIVE
TX POWER
MEASUREMENT***

Two calibration routines must be run when the Cellular Adapter is first connected to the Test Set and any time the Cellular Adapter is serviced and re-attached. One of these routines specifically calibrates the relative TX Power measurement, and must be run to ensure measurement accuracy. See [“I/Q Modulator and Relative TX Power Calibration” on page 287](#).

The main benefit of using this measurement is its ability to measure very low level signals; typically <-80 dBm (10 pico Watts). Also, unlike the Average Power measurement, relative TX Power measurement can be measured through the ANT IN port to measure signals below 50mW (do not exceed 200mW on the ANT IN port). The Input Port is selected on the RF ANALYZER screen.

Power is measured directly by the Cellular Adapter’s Digital Signal Processing (DSP) circuitry. Because it is a relative power measurement, the user must first provide a reference signal at a known level to establish a power measurement reference point before testing the mobile. Subsequent measurements indicate the power level relative to the reference signal’s power. For example; if you used a 0dBm signal for the reference, a signal level from the mobile of -80dBm will be displayed as a TX Power of -80dB.

**Setting a
Measurement
Reference**

A measurement reference is typically established, and TX Power is measured, using the following steps.

1. Connect a reference TDMA signal to the Test System; preferably at a level of 0 dBm.
2. Go to the DIGITAL MEASUREMENTS screen and enter the channel number for the reference signal in the **Traffic Chan** field. Refer to [Figure 48 on page 133](#).
3. Position the cursor immediately in front of the **dB** units for the **TX Power** measurement.
4. Press SHIFT, REF SET, ENTER on the Test Set. The value should change to 0.000000 dB for an instant, and then indicate a changing level of <0.1dB.
5. Remove the reference signal and connect the mobile.
6. Set the mobile to transmit by either establishing a call using the CALL CONTROL screen or by putting the mobile in its test mode.
7. Read the mobile’s TX Power.

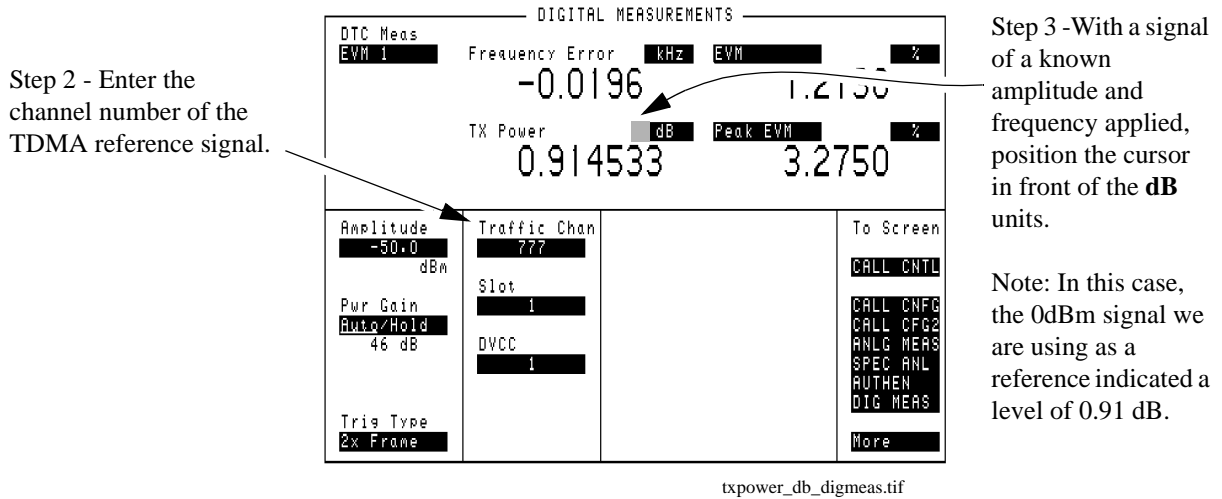

Step 4 - Press SHIFT, REF SET, ENTER to set the present signal level to be the measurement reference level. All subsequent power measurements are relative to the indicated value.

Notice that the Test Set now indicates that the displayed measurement is referenced to some other level.

The 0.004dB reading in this example indicates that the reference signal's level has changed very slightly since the reference level was first set.

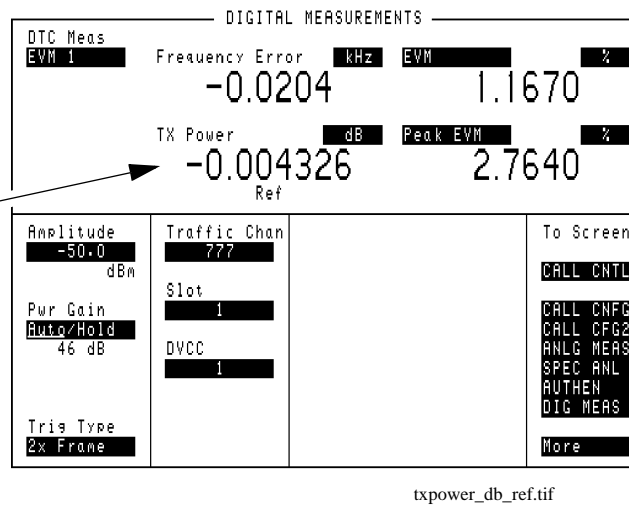

Figure 48 Setting a Relative TX Power measurement reference.

Average Power [W]

Average Power is measured using a special detector in Test Sets with Option 006. This detector provides a measurement range of 50mW to 10W. This is the only way to measure absolute power on a DTC if you are not using a PCS Interface. If you are using a PCS Interface, this measurement is disabled. The RF IN/OUT port of the Test Set must be used for this measurement.

Average Power is the average envelope power over a burst. Because the transmitter is only transmitting during two of the six timeslots in a TDMA frame (slots 1 and 4 in Figure 49), the power measurement must be synchronized to the transmitted bursts. If it was not synchronized, the measurement would include the transmitter's off time during the four "dead" timeslots, greatly reducing the accuracy of the measurement. This is the only way to measure the absolute (rms) power of a TDMA signal without using a PCS Interface. This measurement is not used if the HP 83236B PCS Interface is used.

Once a burst is detected, the cellular adapter starts measuring power when the sixth symbol is received. The measurement continues for at least 140 consecutive symbols; never to measure beyond the 162nd symbol in that burst (when the next timeslot is encountered). The result is a true average of the 140 (or more) received symbols. (This measurement is defined in TIA/EIA standard IS-137 as Digital RF Power Output.)

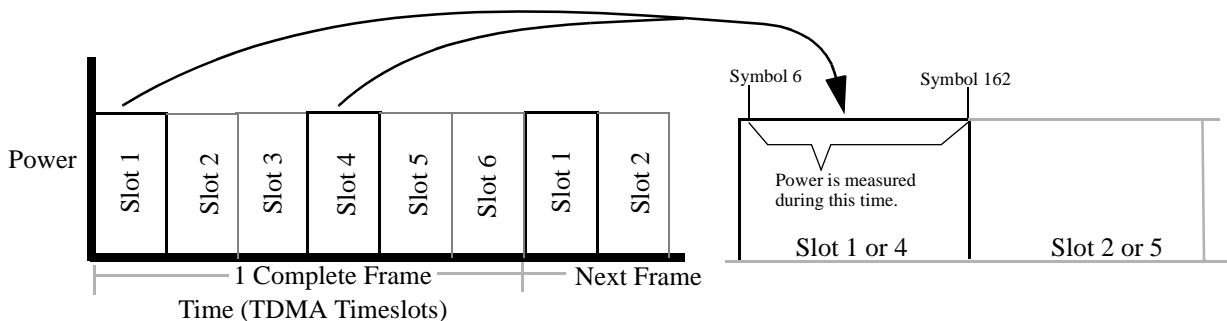

Figure 49 Measuring Average Power

Zeroing the Average Power Meter

Before establishing a call, zero the average power meter by selecting the **Power Meter - zero** field on the DCCCH CALL CONFIGURE screen. (See “Zeroing the Average Power Meter” on page 35). Once zeroed, measurement accuracy is typically $\pm 5\%$ or 0.2dB.

Understanding the Max Abs Measurement

Max Abs is a measure of the power into the analog to digital converter (ADC) at the input of the Cellular Adapter. It is displayed as an aid to troubleshoot measurement problems. If this level drops below -20dB , or goes above -1dB , the level into the ADC is too low or too high and will cause inaccurate measurements.

Max Abs is affected by the transmitter’s power into the Test Set and by the **Pwr Gain** setting. If you select **Pwr Gain - Auto**, then **Max Abs** will automatically remain within the proper limits if the transmitted level is high enough (but not too high). **Auto** is the recommended setting. If you select **Pwr Gain - Hold**, then you must adjust the gain by selecting a setting from the **Choices** menu. **Max Abs** must remain between -1 and -20 dB.

Measuring Average Power on an Active Traffic Channel

1. Access the CALL CONTROL screen.
2. Establish a call between the mobile and the Test System on a digital traffic channel. When established, the **Connect** indicator on the CALL CONTROL screen is “lit” and the **Traffic Chan Assignment - Type:** indicates DTC. See “Registration” on page 93.
3. Select **Meas** from the **Data/Meas** field.
4. Select **Avg Pwr** from the **Choices** menu.
5. The average power is displayed.

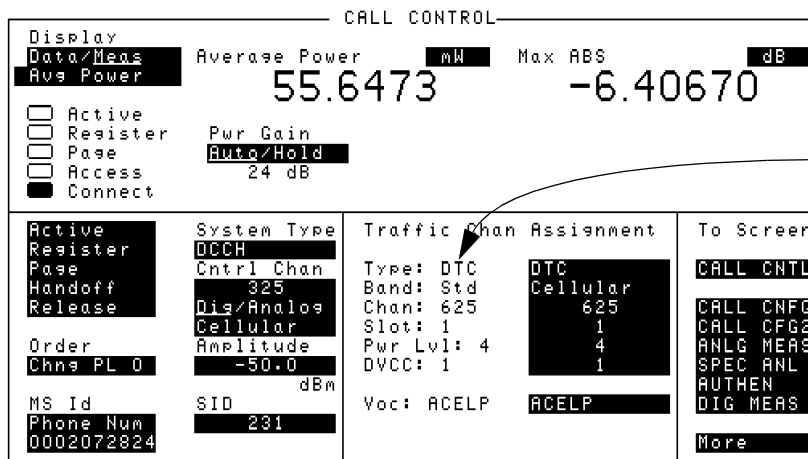

Indicates the type of traffic channel being received

Figure 50

Average Power Measured on the CALL CONTROL Screen

Measuring Average Power with the Mobile in Test Mode

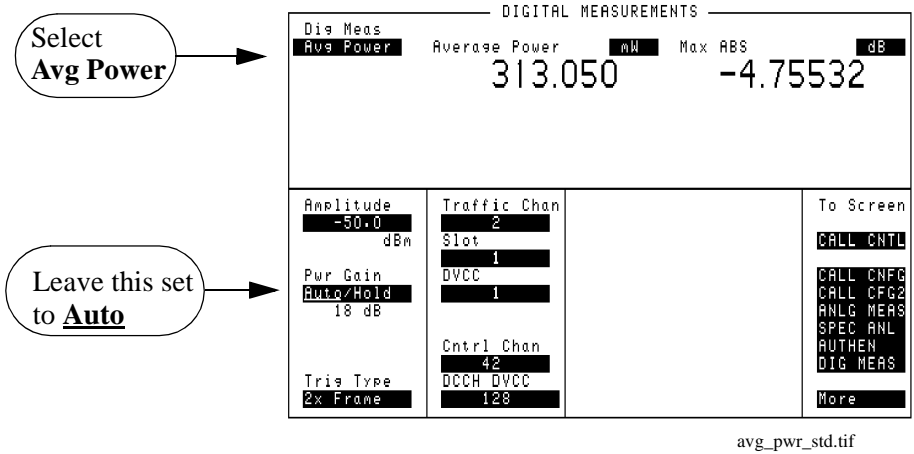

Figure 51 Average Power Measured on the DIGITAL MEASUREMENTS Screen with PCS Interface Disabled

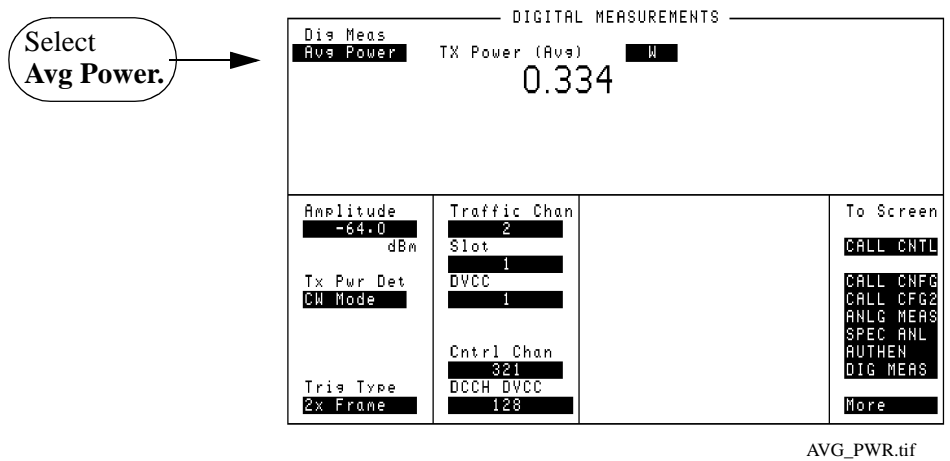

Figure 52 Average Power Measured on the DIGITAL MEASUREMENTS Screen with PCS Interface Enabled

TX Power (Avg) [W]

This is an rms power measurement. It is only available when an HP 83236B PCS Interface is used. This measurement is similar to the **Average Power** measurement. In fact, the Average Power measurement is disabled if the PCS Interface is used because the interface can measure power for both Cellular and PCS signals. Accuracy is typically $\pm 5\%$ or 0.2 dB.

TX Power [W]

This is the absolute (rms) power on an AVC. It is used when a PCS Interface is not attached. The detected signal is converted to an envelope signal voltage (power) and is digitized. The resulting power level is calculated using the following formula:
 $\text{peak power} - 2.95 \text{ dB} = \text{rms power}$

The RF IN/OUT port of the Test Set must be used for this measurement.

Sync Location

Sync location is measured in either Connect state or test mode. The measurement procedure described below is for the Connect state. To measure in the test mode, see “[Test mode measurement procedure](#)” on page 118.

Sync location measures the time in number of bit periods from the trigger to the beginning of the first sync word detected.

Sync location measurement procedure

1. Make sure the Test Set is in Connect state. See “[Registration](#)” on page 93.
2. Select **Meas** from the **Data/Meas** field.
3. Select one of the two measurement fields that can be modified.
4. Select **Sync Loc** from the list of choices. The Sync location measurement will be displayed.

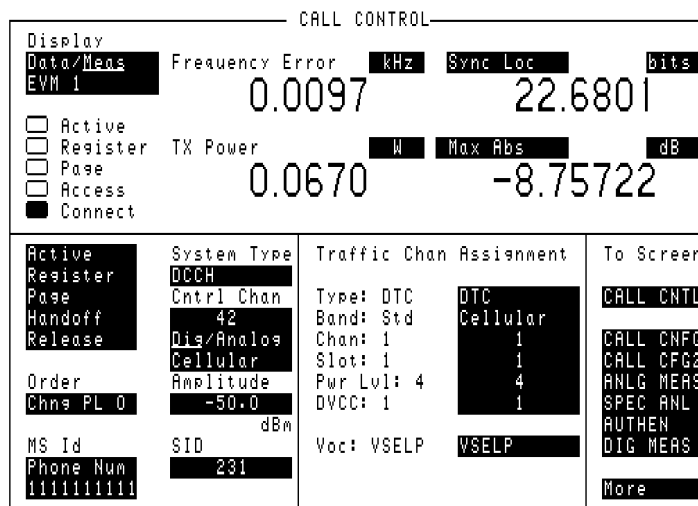

Sync-loc.tif

Figure 53

Sync Location Display

TX Power

Three types of Transmitter Power measurements are available:

- **TX Power [W]** - to measure the absolute power of an Analog Voice Channel (AVC).
- **TX Power [dB]** - To measure the relative power of a Digital Traffic Channel (DTC). This provides a way to measure transmitter power on a DTC when your Test Set does not have Option 006 (50 μ W to 10W Average Power Measurements) or a PCS Interface.
- **TX Power (Avg) [W]** - To measure the absolute power of a DTC or AVC using the PCS Interface.

See [“Power Measurements” on page 130](#) for information on making power measurements.

Measuring Absolute TX Power on an AVC

To measure absolute TX Power when a mobile is in the Connect state, use the following measurement procedure. To measure absolute TX Power when the mobile is in the Test mode, select **ANLG MEAS** (from the **To Screen** list) to display the ANALOG MEAS screen.

TX Power measurement procedure

1. Establish a call between the mobile and the Test System on an analog voice channel. When established, the **Connect** indicator on the CALL CONTROL screen is 'lit' and the **Traffic Chan Assignment - Type:** indicates AVC. See ["Registration" on page 93](#).
2. Select **Meas** from the **Data/Meas** field.
3. Absolute TX Power is displayed, along with other relevant analog measurements.

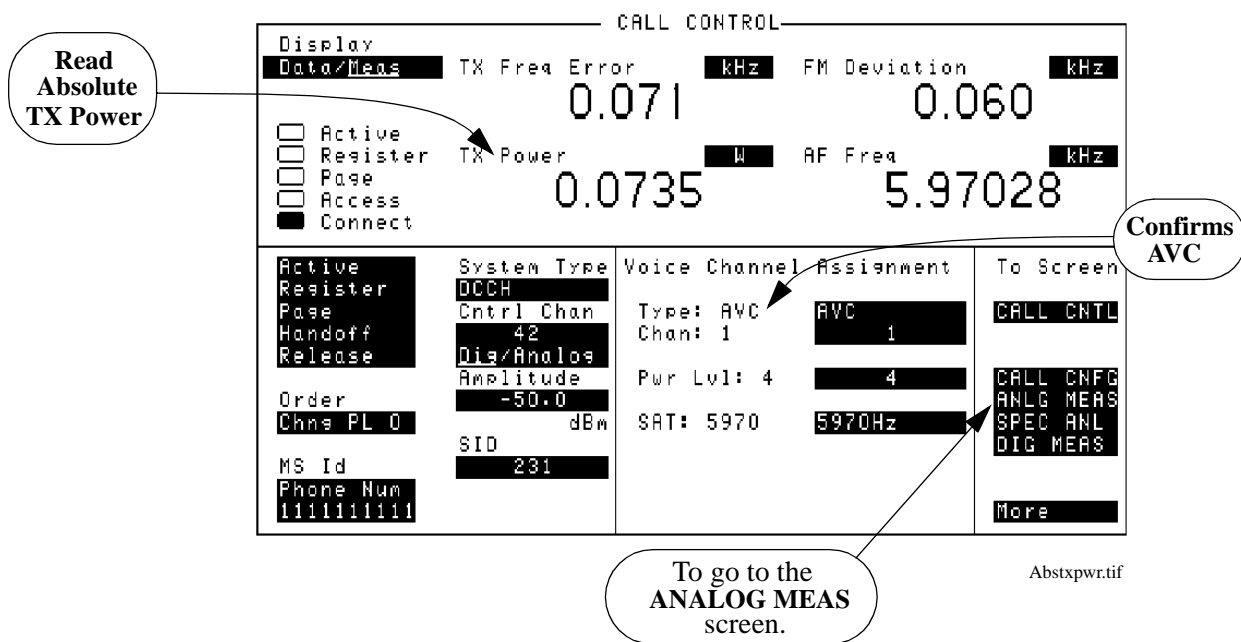

Figure 54 Measuring TX Power on an Analog Voice Channel (AVC)

Measuring Relative TX Power on a DTC

The following measurement procedure is for mobiles in the Connect state. Use the DIGITAL MEASUREMENTS screen to make measurements with the mobile transmitting in the test mode (see “Test mode measurement procedure” on page 118).

1. Access the CALL CONTROL screen.
2. Establish a call between the mobile and the Test System on a digital traffic channel. When established, the **Connect** indicator on the CALL CONTROL screen is ‘lit’ and the **Traffic Chan Assignment - Type:** indicates DTC. See “Registration” on page 93.
3. Select **MEAS** from the **Data/Meas** field.
4. Select **EVM 1** from the **Choices** menu.
5. Relative TX Power is displayed, along with relevant digital modulation measurements.

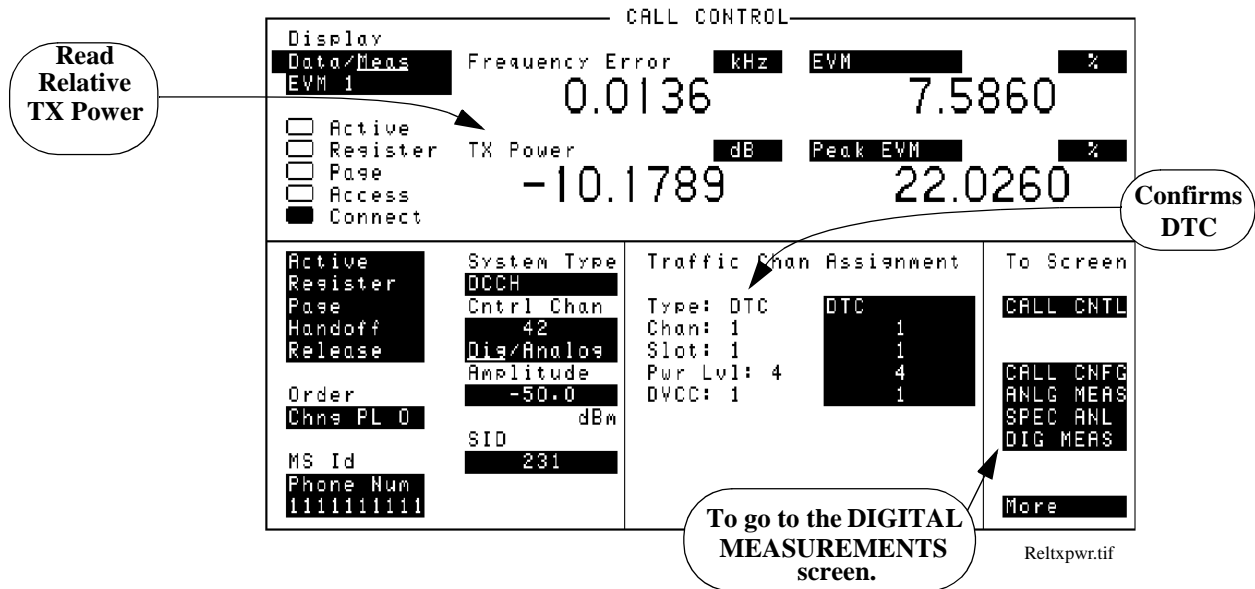

Figure 55

Measuring TX Power on a Digital Traffic Channel (DTC)

Measuring Average Power on an AVC or DTC with the PCS Interface

To measure average TX Power when a mobile is in the Connect state and a PCS Interface is configured and enabled, use the following measurement procedure.

Average TX Power with PCS Interface measurement procedure

1. Set up the PCS Interface as directed in the sections under “About the Cellular Adapter” on page 32.
2. Establish a call between the mobile and the Test System on a digital traffic channel (DTC) (or an analog voice channel (AVC) if you prefer). When established, the **Connect** indicator on the CALL CONTROL screen is ‘lit’ and the **Traffic Chan Assignment - Type:** indicates DTC (or AVC). See “Registration” on page 93.
3. Select **Meas** from the **Data/Meas** field.
4. Average TX Power is displayed, along with other relevant analog measurements.

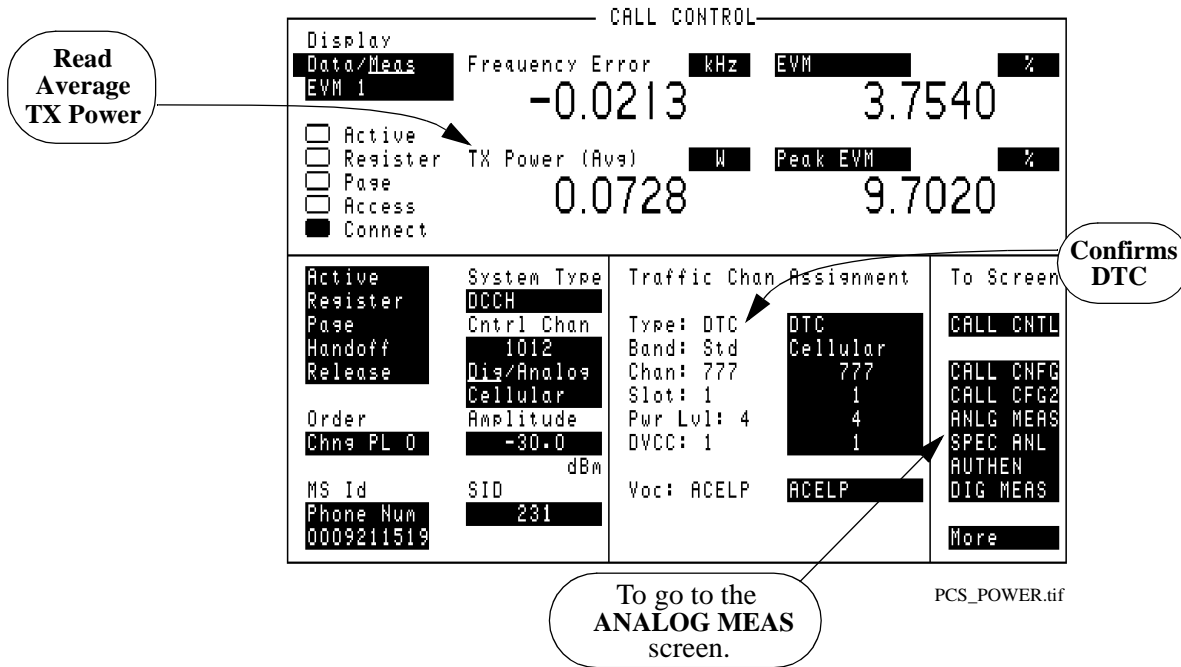

Figure 56

Measuring TX Power on a Digital Traffic Channel (DTC) with a PCS Interface

WER (DTC or DCCH)

DTC WER and DCCH WER can only be measured while the Test Set is in Active mode, and the mobile is in its test mode. The DTC WER measurement is for raw word error rate, measured on a traffic channel. DCCH WER measures word error rate on the control channel.

Each mobile manufacturer has their own method of enabling the test mode for their phones. Those methods will not be discussed here.

DTC WER Measurement Procedure

1. Make sure the Test Set is in Active mode.
2. Select **DIG MEAS** from the **To Screen** menu.
3. Set **Amplitude** to -50 dBm.
4. Select the **Dig Meas** field to display a list of available tests.
5. Select **DTC WER** from the list.
6. Enter the number of word to be measured in the **WER Words** field.
7. Put the mobile into loopback mode.
8. Select the **WER Type** field and choose **Speech**, **FACCH**, or **SACCH** data.
9. Select **Arm**.
10. After the actual number of words has been transmitted and received, the BER should be displayed. the measurements should all read 0.000% at -50 dBm.
11. Gradually reduce the signal's amplitude. You should notice and increase in WER.
12. Raise the signal level back to -50 dBm.
13. Go to the DCCH CALL CONFIGURE screen and enter a number in the **% BIT ERROR** field. This will insert bit errors onto the DTC. Note the response in the WER measurement results.

**How the Test Set
measures WER**

WER is measured in the DIGITAL MEASUREMENT screen.

When the Test Set is in Active state (the Active annunciator is on), the Test Set is emulating a base station, but is not communicating with a mobile.

Selecting Dig Meas while in Active state signals the Test Set to bring up a traffic channel. The data is then transmitted and received over that channel.

The mobile must be in loopback mode. For WER, the mobile demodulates the data, convolutionally decodes it, corrects errors, and then re-transmits the data. (This is different from loopback BER, where the mobile demodulates the data then immediately retransmits it without performing any error correction.)

A word in TDMA is anything that has a CRC calculated on it, such as a speech block, a FACCH, or a SACCH message. Speech and FACCH words are both interleaved over two timeslots. SACCH words are spread over 12 timeslots. The Test Set assembles blocks of data and computes the CRC which is sent to the mobile. The mobile loops the data back to the Test Set after convolutional decoding and error correction. The Test Set checks to see if the received CRC matches the CRC that was sent. If the CRCs do not match, the whole word is considered an error.

DCCH WER is measured differently than DTC WER. For DCCH WER, the mobile reads the DCCH bursts, including the CRC and the shared channel feedback (SCF) in the DCCH data stream. Then, instead of looping back all the DCCH data, the mobile sends back the CRC and SCF to the Test Set. The Test Set checks to see if the CRC and SCF match what was sent.

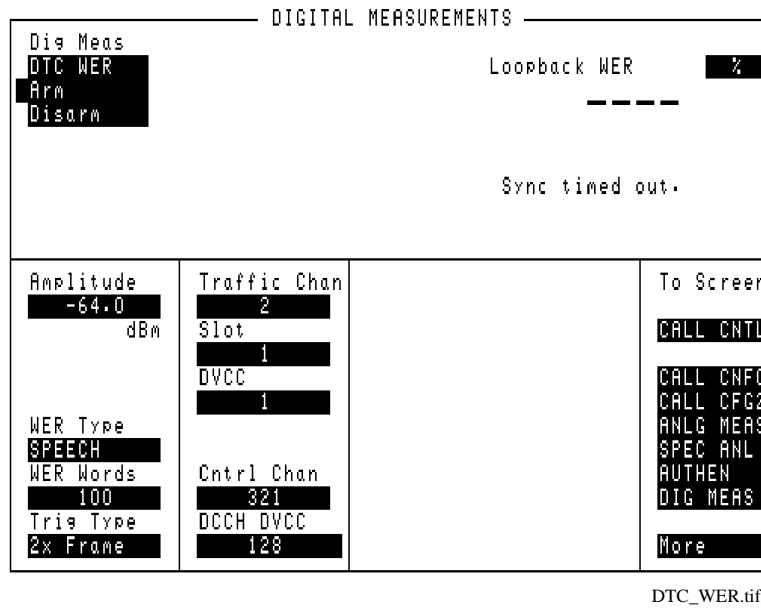

Figure 57 DTC WER Display

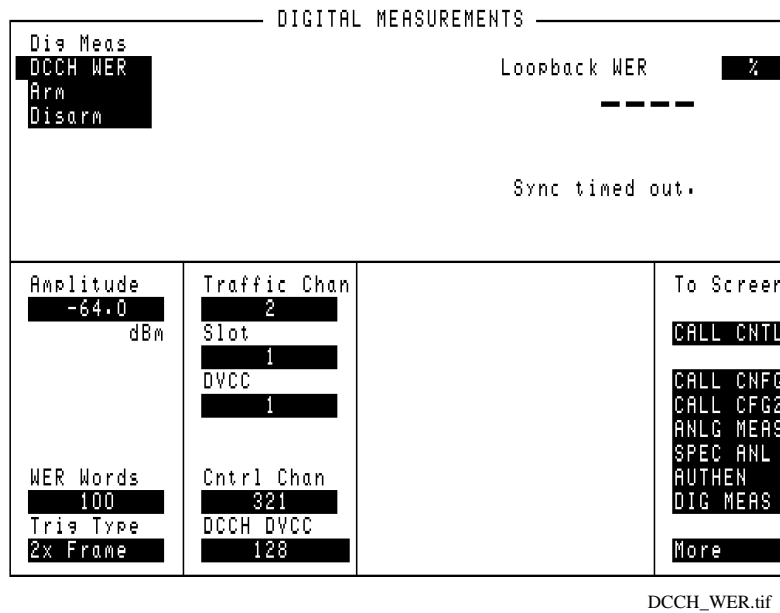

Figure 58 DCCH WER Display

Programming the Cellular Adapter

This chapter describes special features of the Cellular Adapter that are only available through programming.

Programming the Cellular Adapter

This Cellular Adapter cannot be used without a Test Set. Programming the Test Set is described in the *HP 8920B Test Set's Programmer's Guide*. Use the Test Set's programming information, along with information here and in [Chapter 6, "HP-IB Syntax Diagrams,"](#) on page 169 to program the functions you need for DAMPS and DCCH.

In order to program many of the analog measurements, you will need to refer to the *HP 8920B Test Set's Programmer's Guide*.

Programming in the Call Processing Subsystem

Any time you access the Call Control screen and its supported screens you are operating in the Call Processing Subsystem. Remote operation in this subsystem requires certain programming structures to help eliminate operating errors.

For example, it is very important to use the subsystem's status registers to monitor the call status annunciators to control program flow. Failure to use correct programming procedures could result in instrument lockup.

Therefore, it is important that you read and understand the information in the *HP 8920B Test Set's Programmer's Guide* entitled "Programming the Call Processing Subsystem".

Program Example

This section contains a program example using many of the most frequently needed commands. Excerpts from this program have been used to make more topic-specific program examples as used in [Chapter 3, “Processing Calls,”](#) on [page 61](#).

HP BASIC Program Example

```
100 ! re-save dcch_example
101 ! This program shows how to perform some of the basic
102 ! tasks of call processing for DCCH.
103 ! System type is DCCH
104 COM Testsys
105 CLEAR SCREEN
106 Testsys=714
107 ! Reset the Test System
108 OUTPUT Testsys;"*RST;*OPC?"
109 ENTER Testsys;Done
110 ! Display the Call Processing Screens and select system
111 ! type DCCH
112 OUTPUT Testsys;"DISP ACNT" !Displays analog call screen
113 OUTPUT Testsys;"CPR:CSYS `DCCH'" !System type DCCH
114 ! Make sure Test System is now in Active state
115 REPEAT
116 WAIT 3!Give Test System time to service other processes
117 OUTPUT Testsys;"STAT:CALLP:COND?"
118 ENTER Testsys;Active_status
119 UNTIL Active_status=1
120 PRINT "Test System is now emulating a DCCH base station."
121 PRINT "Active annunciator should be lit."
122 ! Change control channel number to 333
123 OUTPUT Testsys;"CPR:DCCH:CCH 333"
124 ! Make sure Test System is again in Active state
125 REPEAT
126 WAIT 2 !Give Test System time to service other processes
```

Chapter 5, Programming the Cellular Adapter

Program Example

```
127 OUTPUT Testsys;"STAT:CALLP:COND?"
128 ENTER Testsys;Active_status
129 UNTIL Active_status=1
130 PRINT "Test System is now emulating a DCCH base station, channel 333."
131 PRINT "Active annunciator should be lit."
132 ! Zero power meter
133 PRINT "Disconnect cables from RF In/Out port."
134 INPUT "Press ENTER when phone is disconnected.",A$
135 OUTPUT Testsys;"CPR:DCCH:ZPOW" !zero the power meter
136 PRINT "Re-connect phone now."
137 PRINT "Turn on phone now."
138 INPUT "Press ENTER when phone has camped on a control channel.",A$
139 ! Register phone. Check success by monitoring Register annunciator
140 ! turning off.
141 OUTPUT Testsys;"STAT:CALLP:PTR 0" !Don't latch positive transitions
142 OUTPUT Testsys;"STAT:CALLP:NTR 2" !Latch the Register annunciator
143 ! turning off.
144 OUTPUT Testsys;"*CLS" !Clear Status Event Registers
145 OUTPUT Testsys;"CPR:DCCH:REGisTer" !The Register command
146 REPEAT
147   OUTPUT Testsys;"*ESR?;:STAT:CALLP:EVENT?" !Check for errors or
148   ! Registration success
149   ENTER Testsys;Esr,Register
150   WAIT 2 !Give Test System time to service other processes
151   UNTIL Register OR Esr
152   IF Esr THEN
153     PRINT "Error with Registration"
154     STOP
155   ELSE !Registration should have completed
156     OUTPUT Testsys;"CPR:PNUM?" !Get the phone number of the mobile
157     ENTER Testsys;Phone_num
158     PRINT "Registration was successful!"
159     PRINT "Phone number is ";Phone_num
160   END IF
161   ! End Registration
162   ! Page Mobile
163   PRINT "When the phone rings, press SEND"
```

Chapter 5, Programming the Cellular Adapter
Program Example

```
164 OUTPUT Testsys;"STAT:CALLP:PTR 32" !Latch Connect annunciator
165 ! positive transition.
166 OUTPUT Testsys;"STAT:CALLP:NTR 0" !Don't latch negative transitions
167 OUTPUT Testsys;"*CLS" !Clears all Event Status Registers
168 OUTPUT Testsys;"CPR:DCCH:PAGE" !The Page command
169 REPEAT !Wait for the Test System and the mobile to connect
170   OUTPUT Testsys;"*ESR?;:STAT:CALLP:EVENT?"
171   ENTER Testsys;Esr,Connect
172   WAIT 2 !Give Testsys time to service other processes
173 UNTIL Connect OR Esr !Until mobile connects or an error occurs
174 IF Esr THEN
175   PRINT "Error with Page"
176   STOP
177 END IF
178 PRINT "Page was successful"
179 ! End Page
180 ! Since we used the DCCH default settings, we know that we are
181 ! on a DTC. Now we will query for some of the present parameters.
182 OUTPUT Testsys;"CPR:DCCH:CONN:TYPE?" !Queries for channel type
183   ENTER Testsys;Chan_type$ ! read the channel type (will be DTC)
184   PRINT "The channel type is ";Chan_type$
185 OUTPUT Testsys;"CPR:DCCH:CONN:SLOT?" !Queries for slot number
186   ENTER Testsys;Slot_num$ ! read the slot number
187   PRINT "The slot number is ";Slot_num$
188 OUTPUT Testsys;"CPR:DCCH:CONN:POW?" !Queries for power level
189   ENTER Testsys;Pow_level$ ! read the power level
190   PRINT "The power level is ";Pow_level$
191 OUTPUT Testsys;"CPR:DCCH:CONN:DVCC?" !Queries for DVCC value
192   ENTER Testsys;DVCC_val$ ! read the DVCC value
193   PRINT "The DVCC is ";DVCC_val$
194 ! End DTC parameter query
195 ! Change DTC Power Level (send an order)
196 OUTPUT Testsys;"CPR:DCCH:DTCH:DMAC?" !Queries for power level
197   ENTER Testsys;DMAC_lvl ! read the power level
198   PRINT "The power level is ";DMAC_lvl
199 OUTPUT Testsys;"CPR:DCCH:DTCH:ORD 'CHNG PL 8'" !Change to level 8
200 WAIT 2 !Give Testsys time to service other processes
```

Chapter 5, Programming the Cellular Adapter

Program Example

```
201 OUTPUT Testsys;"CPR:DCCH:DTCH:DMAC?" !Confirm new power level
202 ENTER Testsys;DMAC_lvl ! read the power level
203 PRINT "The new power level is ";DMAC_lvl
204 ! End DTC power level change
205 ! Make measurements on the DTC
206 OUTPUT Testsys;"CPR:DCCH:DMODE 'MEAS'" !Change to Measure mode
207 WAIT 2 !Give Testsys time to service other processes
208 OUTPUT Testsys;"MEAS:DCCH:EVMM:FERR?" !Measure frequency error
209 ENTER Testsys;Freq_err ! read the frequency error
210 PRINT "The frequency error is ";Freq_err
211 OUTPUT Testsys;"MEAS:DCCH:EVMM:TPOW?" !Measure TX power
212 ENTER Testsys;TX_power ! read the TX power
213 PRINT "The TX power is ";TX_power
214 OUTPUT Testsys;"MEAS:DCCH:EVMM:DR0op?" !Measure droop
215 ENTER Testsys;droop ! read droop
216 PRINT "The droop is ";droop
217 ! Change the measurement type to Average Power
218 OUTPUT Testsys;"CPR:DCCH:MTYPE 'AVG POWER'" !Measurement type
219 OUTPUT Testsys;"MEAS:DCCH:APOW?" ! Measure Average Power
220 WAIT 2 !Give Testsys time to service other processes
221 ENTER Testsys;Avg_power ! read Average Power
222 PRINT "The Average Power is ";Avg_power
223 ! End Average Power measurement
224 ! End measurements on the DTC
225 ! Set up AVC parameters in preparation for a handoff
226 OUTPUT Testsys;"CPR:DCCH:VTYPE 'AVC'" !Set channel type to AVC
227 OUTPUT Testsys;"CPR:DCCH:AVCH:VCH 995" !Set voice channel to 995
228 OUTPUT Testsys;"CPR:DCCH:AVCH:VMAC 4" !Set power level to 4
229 OUTPUT Testsys;"CPR:DCCH:AVCH:SAT '6030Hz'" !Set the SAT
230 ! Handoff to the AVC
231 OUTPUT Testsys;"STAT:CALLP:PTR 32" !Latch Connect annunciator
232 ! positive transition
233 OUTPUT Testsys;"STAT:CALLP:NTR 0" !don't latch negative transitions
234 OUTPUT Testsys;"*CLS" !Clear Event Status Registers
235 OUTPUT Testsys;"CPR:DCCH:HAND" !Handoff command
236 REPEAT !Wait until handoff has occurred and Test System is again in
237 ! Connect state.
```

Chapter 5, Programming the Cellular Adapter
Program Example

```
238  OUTPUT Testsys;"*ESR?::STAT:CALLP:EVENT?" !Check for Connect/
error
239  ENTER Testsys;Esr,Connect
240  WAIT 5 ! Give Testsys time to service other processes
241  UNTIL Connect or Esr !Until mobile has reconnected or an error
242  IF Esr THEN
243    PRINT "Error with Handoff"
244    STOP
245  END IF
246  PRINT "Handoff was successful."
247  ! Release call
248  PRINT "Releasing call..."
249  OUTPUT Testsys;"CPR:DCCH:REL" !Release command
250  ! Make sure Test System is again in Active state
251  REPEAT
252  WAIT 2
253  OUTPUT Testsys;"STAT:CALLP:COND?"
254  ENTER Testsys;Active_status
255  UNTIL Active_status=1
256  PRINT "Call has been released."
257  PRINT "Active annunciator should be lit."
258  PRINT "Program has finished."
259  END
```

Displaying the DCCH screens

Table 4 lists the command mnemonics for displaying the screens available in the Cellular Adapter. For other screens, refer to the *HP 8920 series Programmer's Guide*.

Note that to display the DCCH CALL CONTROL screen, you must display the CALL CONTROL screen (ACNT) and change system type to DCCH.

Table 4

DCCH Call Processing screen mnemonics

Screen	Mnemonic
Call Control	ACNT
Call Configure	DCON
Analog Measurement	CME
Digital Measurement	DME
Spectrum Analyzer	SAN

Sample syntax to display each DCCH Call Processing screen

```
! Display the Call Control screen
OUTPUT 714;"DISP ACNT"

! Change the system type to DCCH
OUTPUT 714;"CPR:CSYS `DCCH`"

! Display the Call Configure screen
OUTPUT 714;"DISP DCON"

! Display the Analog Measurement screen
OUTPUT 714;"DISP CME"

! Display the Digital Measurement screen
OUTPUT 714;"DISP DME"

! Display the Spectrum Analyzer screen
OUTPUT 714;"DISP SAN"
```

Status Registers for DCCH Call Processing

The status registers which can be queried for DCCH are the same as for AMPS. Refer to the *HP 8920 Test Set's Programmer's Guide* for more information.

The Status Register Group for Call Processing consists of four 16-bit registers:

- The Condition Register indicates the status of specific Test System conditions, such as whether it has successfully connected to the mobile. [Table 5](#) lists the conditions and values associated with the Call Control annunciators. (See [“Example program for the Condition Register” on page 156](#))
- Transition Filters are used to specify when changes to the Condition Register get passed to the Event Register (always, never, or by a high-to-low or low-to-high transition).
- The Event Register indicates what events have occurred since it was last cleared; it is a read-only register to track events.
- The Enable Register specifies what conditions in the Event register are allowed to be passed to the Status Byte.

There is also a Summary Message for this Status Register Group.

Table 5 Partial Description of Condition Register Bit assignments (Bits 0-5 only)

Bit Number	Binary Weighting	Condition	Comment
5	32	Connect state	bit state mirrors the condition of the annunciator on the display (1=ON, 0=OFF)
4	16	Access state	bit state mirrors the condition of the annunciator on the display (1=ON, 0=OFF)
3	8	Page state	bit state mirrors the condition of the annunciator on the display (1=ON, 0=OFF)
2	4	unused	
1	2	Register state	bit state mirrors the condition of the annunciator on the display (1=ON, 0=OFF)
0	1	Active state	bit state mirrors the condition of the annunciator on the display (1=ON, 0=OFF)

Example program for the Condition Register

```
100 ! re-save condreg_example
101 ! This program shows how to read the
102 ! Condition Register.
103 COM Testsys
104 CLEAR SCREEN
105 Testsys=714
106 ! Reset the Test System
107 OUTPUT Testsys;"*RST;*OPC?"
108 ENTER Testsys;Done
109 ! Display the Call Control screen
110 OUTPUT Testsys;"DISP ACNT"
111 ! Change the system type to DCCH
112 OUTPUT Testsys;"CPR:CSYS `DCCH`"
113 PRINT "Wait for the Test System to be in Active state"
114 PRINT "Wait for the phone to camp"
115 INPUT "Press ENTER when Active annunciator is lit.",A$
116 ! Query the Condition Register
117 OUTPUT Testsys;"STAT:CALLP:COND?"
118 ! Read and display the register's value
119 ENTER Testsys;Register_value
120 PRINT "Value of Condition Register during Active"
121 PRINT "state should be 1."
122 PRINT "Value of Condition Register is ";Register_value
123 ! Page a call
124 OUTPUT Testsys;"CPR:DCCH:PAGE"
125 ! Press SEND on the mobile when it rings
126 ! Wait for the call to connect
127 PRINT "Wait for the phone to ring, then press the SEND"
128 PRINT "button on the phone."
129 INPUT "Press ENTER when phone has connected.",A$
130 ! Query the Condition Register
131 PRINT "Value of Condition Register during Connect"
132 PRINT "state should be 32."
133 OUTPUT Testsys;"STAT:CALLP:COND?"
134 ! Read and display the register's value
```

Chapter 5, Programming the Cellular Adapter
Status Registers for DCCH Call Processing

```
135 ENTER Testsys;Register_value
136 PRINT "Value of the Condition Register is ";Register_value
137 PRINT "Program is finished."
138 END
```

Triggering and Remote to Local mode transitions

The Test Set switches from Local to Remote mode upon receipt of the Remote message. No instrument settings are changed, but triggering is set to its last state in Remote mode.

When the Test Set switches from Remote to Local mode, all currently active measurements are flagged as invalid, and in some cases, triggers are restarted.

For more information, see Triggering Measurements in the *HP 8920 Test Set's Programmer's Guide*.

FACCH and SACCH programming

This function can only be controlled through HP-IB. FACCH and SACCH have no equivalent display fields.

FACCH and SACCH description

The Reverse Digital Traffic Channel (RDTC) is a digital channel from the mobile to the base. It contains information about topics like connection, measurement orders, channel quality, DTMF, status, and SSD updates.

The RDTC has two separate control channels: Fast Associated Control Channel (FACCH), and Slow Associated Control Channel (SACCH). These are the two channels which can be programmed with messages.

The FACCH replaces the user information block whenever it is to be transmitted. The FACCH can consist of more than one word. User information blocks can be interspersed with the FACCH words.

The SACCH uses 12 coded bits per TDMA burst. This data stream is continuous.

Programming commands for FACCH and SACCH

HP-IB commands for the FACCH and SACCH follow.

CPOVerride:ENABLE
CPOVerride:DISable

Call Processing Override Action.

Enable this command when you want to control how much Layer 2 and Layer 3 DTC call processing occurs. When enabled, the only Layer 2 processing performed is calculation of the CRC of the Layer 2 word and filtering of Layer 2 SACCH frames. Layer 3 call processing is completely turned off.

Syntax

```
CALLP:DCCH:FSACch:CPOVerride:ENABLE  
CALLP:DCCH:FSACch:CPOVerride:DISable
```

FALog:ENABLE

FALog:DISable

DTC FACCH Word Log Action

Enable this command to send any received reverse FACCH Word message over HP-IB. The command RFSWord sends this information.

Syntax

CALLP:DCCH:FSACch:FALog:ENABle

CALLP:DCCH:FSACch:FALog:DISable

SALog:ENABle

SALog:DISABle

DTC SACCH Word Log Action

Enable this command to send any received non-NULL reverse SACCH Word message over HP-IB. The command RFSWord sends this information.

Syntax

CALLP:DCCH:FSACch:SALog:ENABle

CALLP:DCCH:FSACch:SALog:DISABle

BCount <Block Count>
BCount:UPDate
BCount?

DTC Block Count Field

This sets the internal block counter. This field must be updated before being queried. Maximum count is $2^{32} - 1$, after which the counter rolls over to zero. The block counter is automatically updated every 20 ms.

Syntax

CALLP:DCCH:FSACch:BCount <Block Count>

CALLP:DCCH:FSACch:BCount:UPDate

CALLP:DCCH:FSACch:BCount?

PERiod <Period>
PERiod:UPDate
PERiod?

DTC Period Field

If the period is set to a non-zero value, then the scheduled words will be transmitted starting at zero and repeating every “Period” blocks. Words scheduled in blocks greater than the Period will not be sent. If the period is zero, then no words are sent.

Syntax

```
CALLP:DCCH:FSACch:PERiod <Period>  
CALLP:DCCH:FSACch:PERiod:UPDate  
CALLP:DCCH:FSACch:PERiod?
```

FACCh:FFSWord <Forward Block>, <Default Flag Command string>, <Word Command string>

SACCh:FFSWord <Forward Block>, <Default Flag Command string>, <Word Command string>

Forward FACCH or SACCH Word Action

This is the command that creates the message to be sent. It instructs the Test Set to schedule the words to be transmitted at the Forward Block Count. You can send one to four words. Each word consists of a 13 digit hexadecimal string.

The Default Flag Command string: composed of one hexadecimal digit per word in the Word Command String. The first digit corresponds to the first word in the Word Command string, the second digit to the second word, and so on. If the digit is non-zero, the word will be transmitted each time the internal block count is equal to the block the word was assigned to. If the digit is zero, the word will be transmitted only once.

The Word Command string: one to four 13 digit hexadecimal strings. Each string separates a FACCH or SACCH word. The leftmost digit is the word header and the remaining 12 digits are the word contents.

Syntax

```
CALLP:DCCH:FACCh:FFSWord '<Forward Block>,<Default Flag Command string>,<Word Command string>'
```

```
CALLP:DCCH:SACCh:FFSWord '<Forward Block>,<Default Flag Command string>,<Word Command string>'
```

Sample

```
CALLP:DCCH:FACCh:FFSWord '300,10,0123456789ABC FEDCBA9876543'
```

0123456789ABC is the first word, and is repeated;

FEDCBA9876543 is the second word, and is not repeated.

In the string '10', the 1 indicates repeat, the zero indicates don't repeat. Two digits in this string indicate that there are two words to come in the Word Command string.

FACCh:SEND
FACCh:STOP
SACCh:SEND
SACCh:STOP
FSACCh:SEND
FSACCh:STOP

Send or stop the sending of the word sequence

These commands start and stop the sending of words. If a SACCH word has not been scheduled for a given block, the word for that block will contain filler bits. If a FACCH word has not been scheduled for a given block, a valid speech frame will be sent.

Note: if the Period has been set to zero, no words are sent.

Syntax

CALLP:DCCH:FSACCh:SEND

This command starts the sending of any FACCH or SACCH words previously scheduled.

CALLP:DCCH:SACCh:STOP

This command stops the sending of the SACCH words only.

FACCh:CLear <block>, <Num Words>
FACCh:CLear:ALL
SACCh:CLear <block>, <Num Words>
SACCh:CLear:ALL
FSACch:CLear <block>, <Num Words>
FSACch:CLear:ALL

Clear Forward FACCH/SACCH word sequence action

This command removes the words at the specific block counts.

Syntax

```
CALLP:DCCH:FACCh:CLear '<block count>,<Num Words>'  
CALLP:DCCH:FACCh:CLear:ALL
```

Sample

```
CALLP:DCCH:FACCh:CLear '302,7'
```

Clears the 7 consecutive FACCH words starting with the word at Block Count 302. That means words in blocks 302 - 308 are cleared.

HP-IB Syntax Diagrams

This chapter provides the syntax specific to the HP 83206A Cellular Adapter. To program the Test Set, refer also to the *HP 8920 RF Test Set's Programmer's Guide*.

Overview

This chapter identifies the DCCH subsystem's HP-IB syntax. It also identifies syntax additions made to the Measurement subsystem which occur when you use this Cellular Adapter.

The DCCH subsystem is an HP-IB subsystem and is similar to the CALL Process subsystem as described in the *HP 8920 RF Communications Test Set Programmer's Guide*. It contains many similar commands, but the commands described here apply to the DCCH portion of the Test Set.

Refer to "Diagram Conventions" on page 171 to understand the syntax structure.

Diagram Conventions

Use the following diagram to see the conventions used in the syntax diagrams.

Statement elements are connected by lines. Each line can be followed in only one direction, as indicated by the arrow at the end of the line. Any combination of statement elements that can be generated by starting at the root element and following the line the proper direction is syntactically correct. An element is optional if there is a path around it. The drawings show the proper use of spaces. Where spaces are required they are indicated by a hexagon with the word “space” in it, otherwise no spaces are allowed between statement elements.

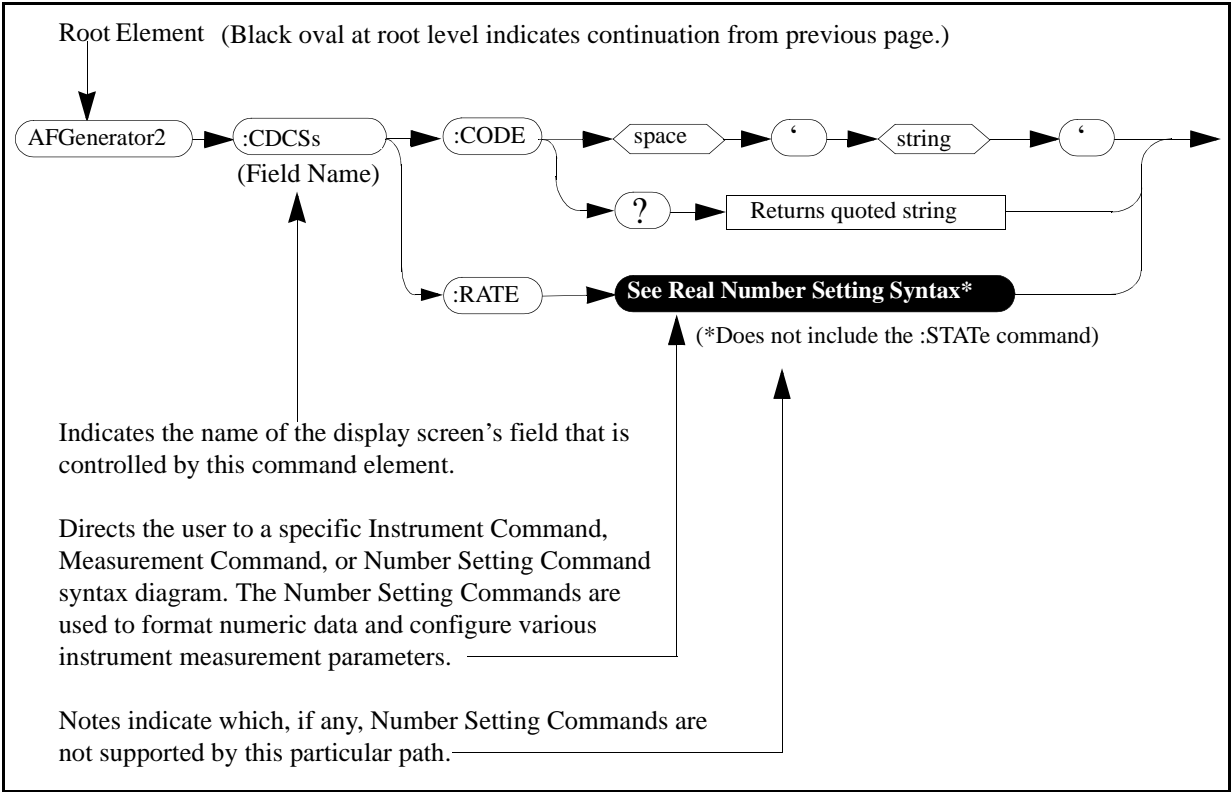

DCCH

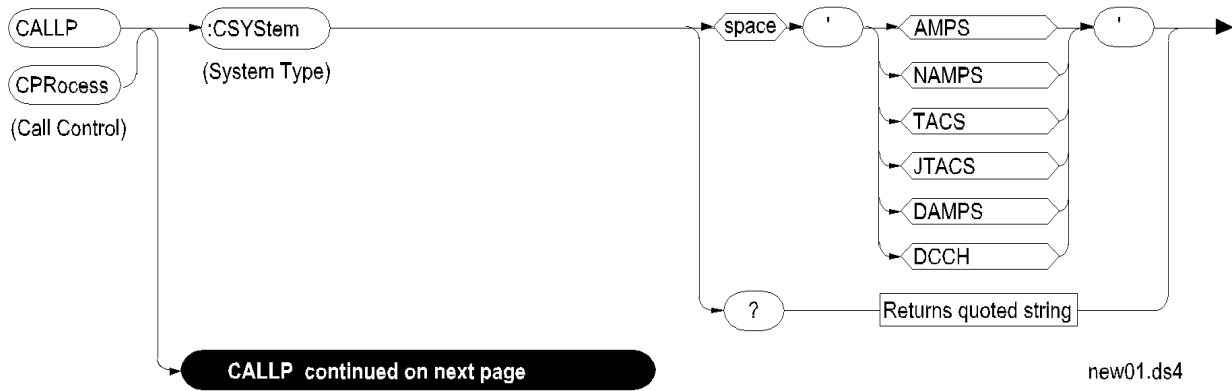

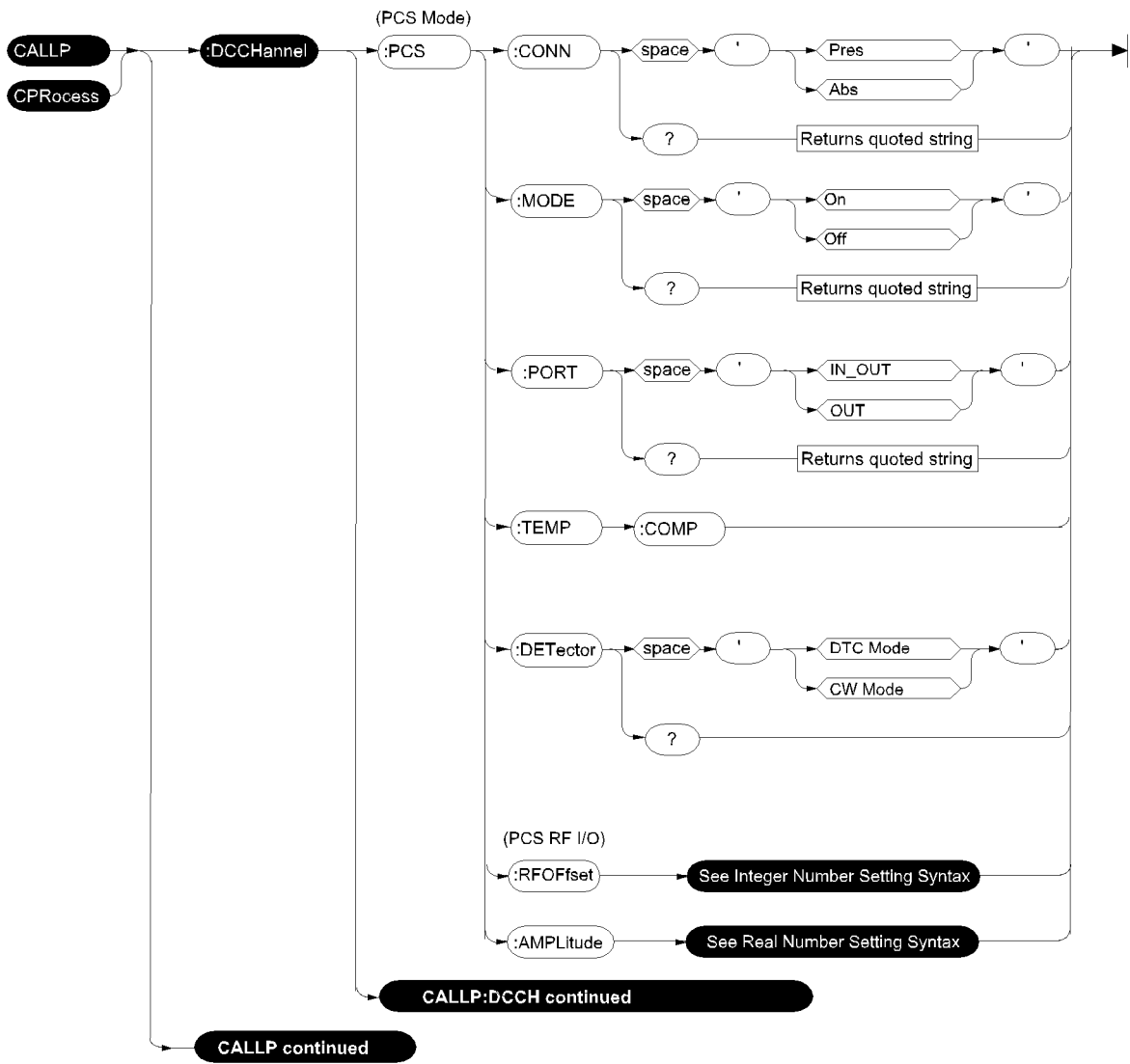

new43.ds4

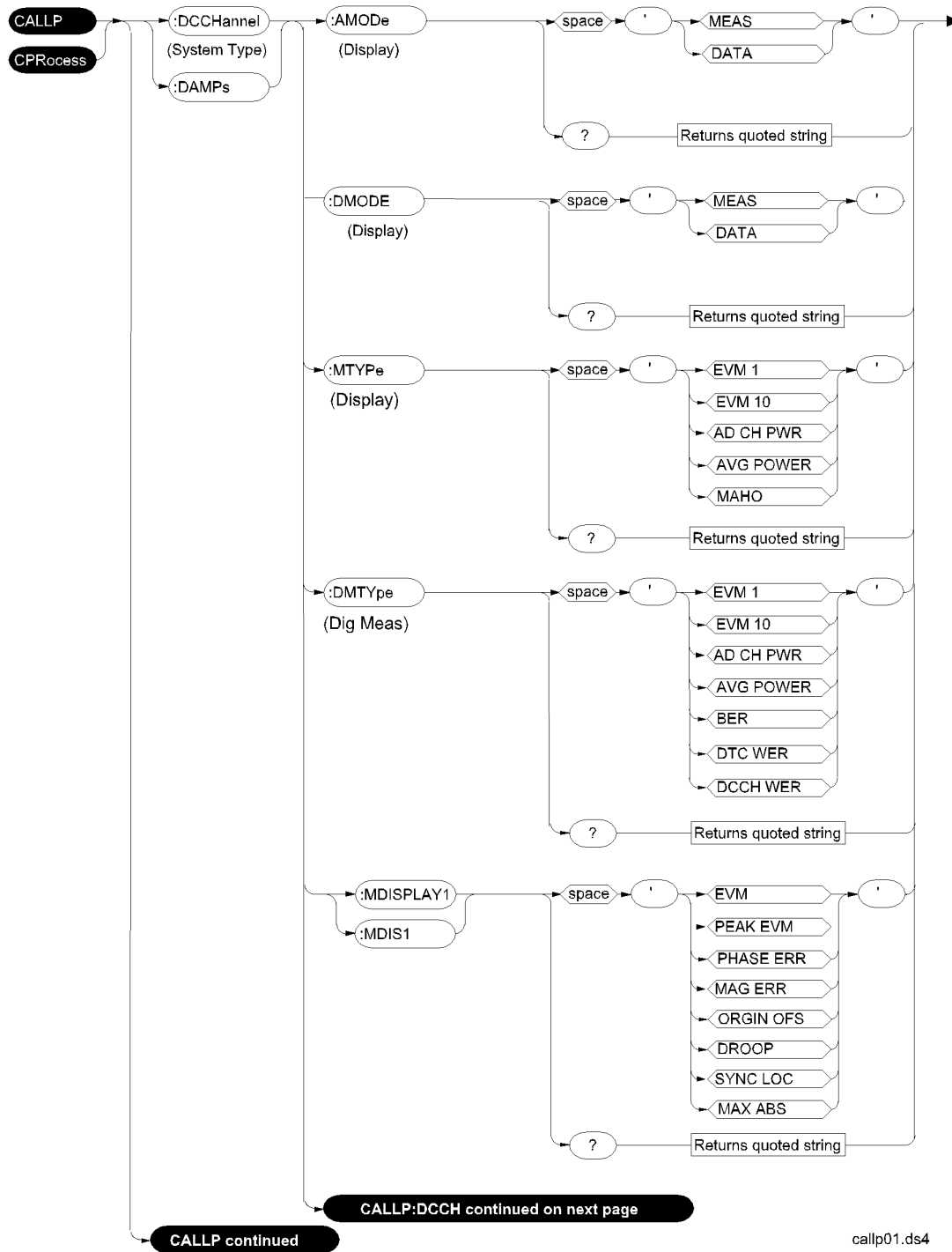

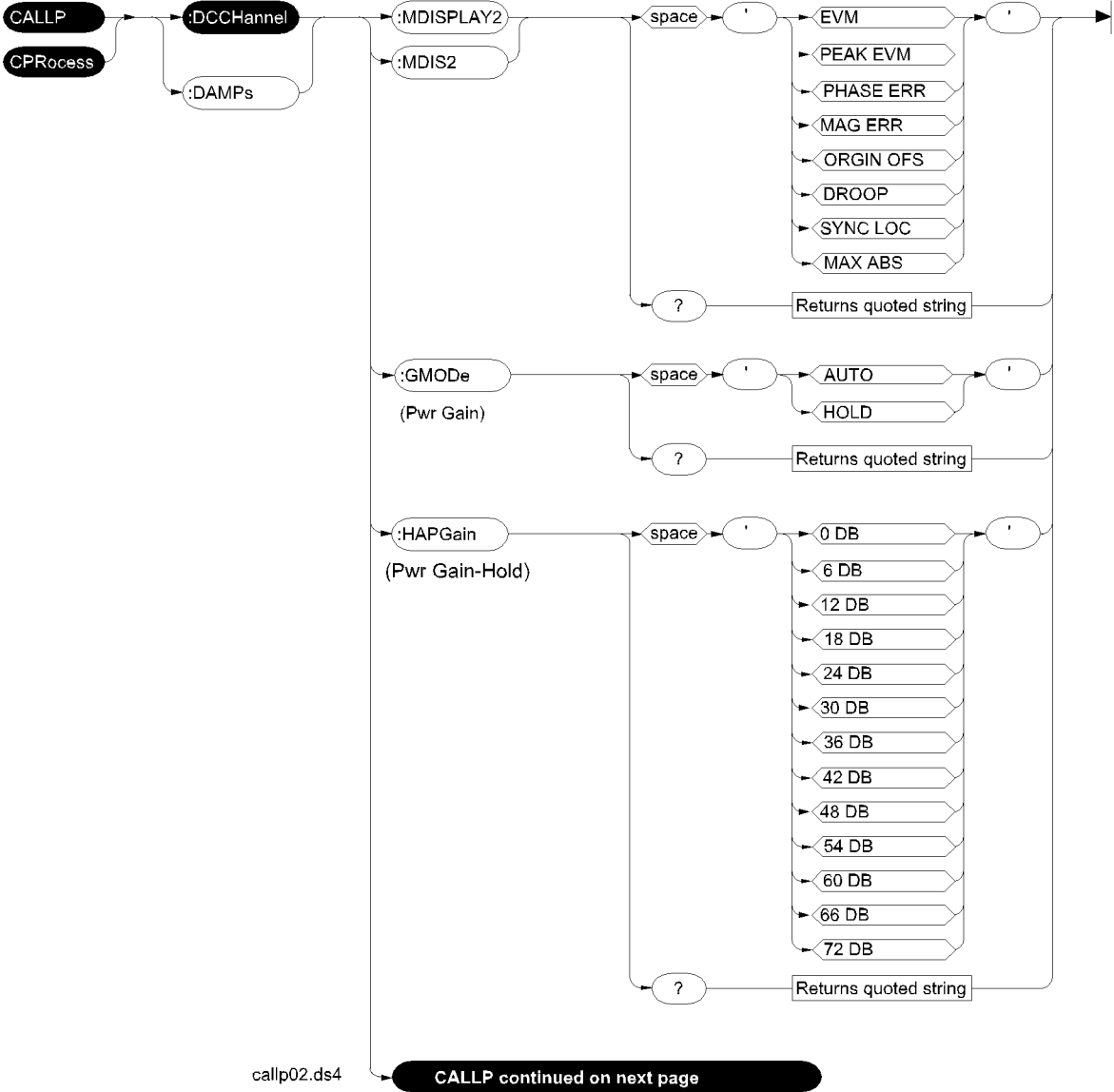

:HAPGain is used for setting gain for average power measurements. :HEGain is used for EVM measurements. :AGain is used for automatic power gain for digital measurements.

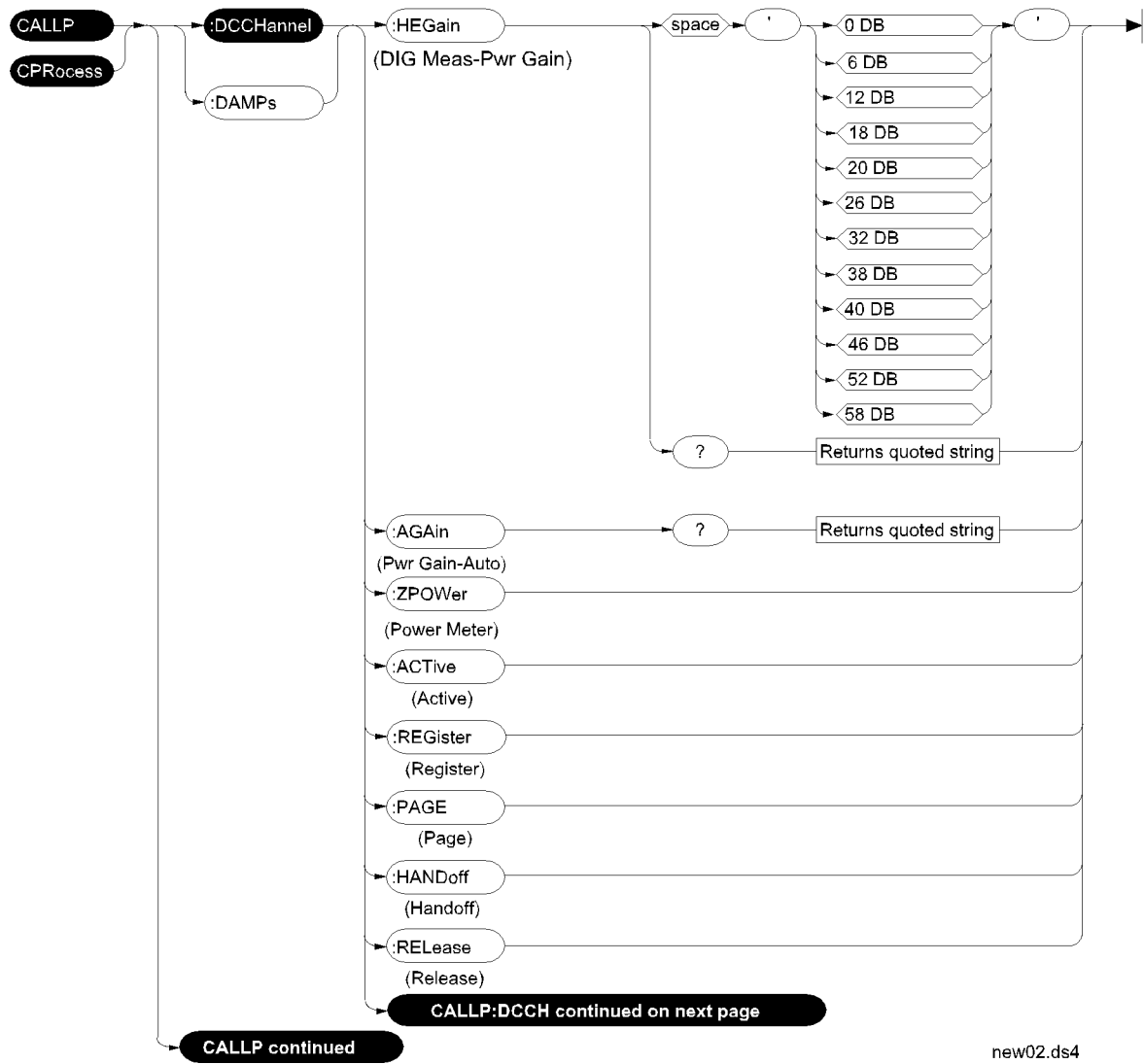

:HAPGain is used for setting gain for average power measurements. :HEGAIN is used for EVM measurements. :AGAIN is used for automatic power gain for digital measurements.

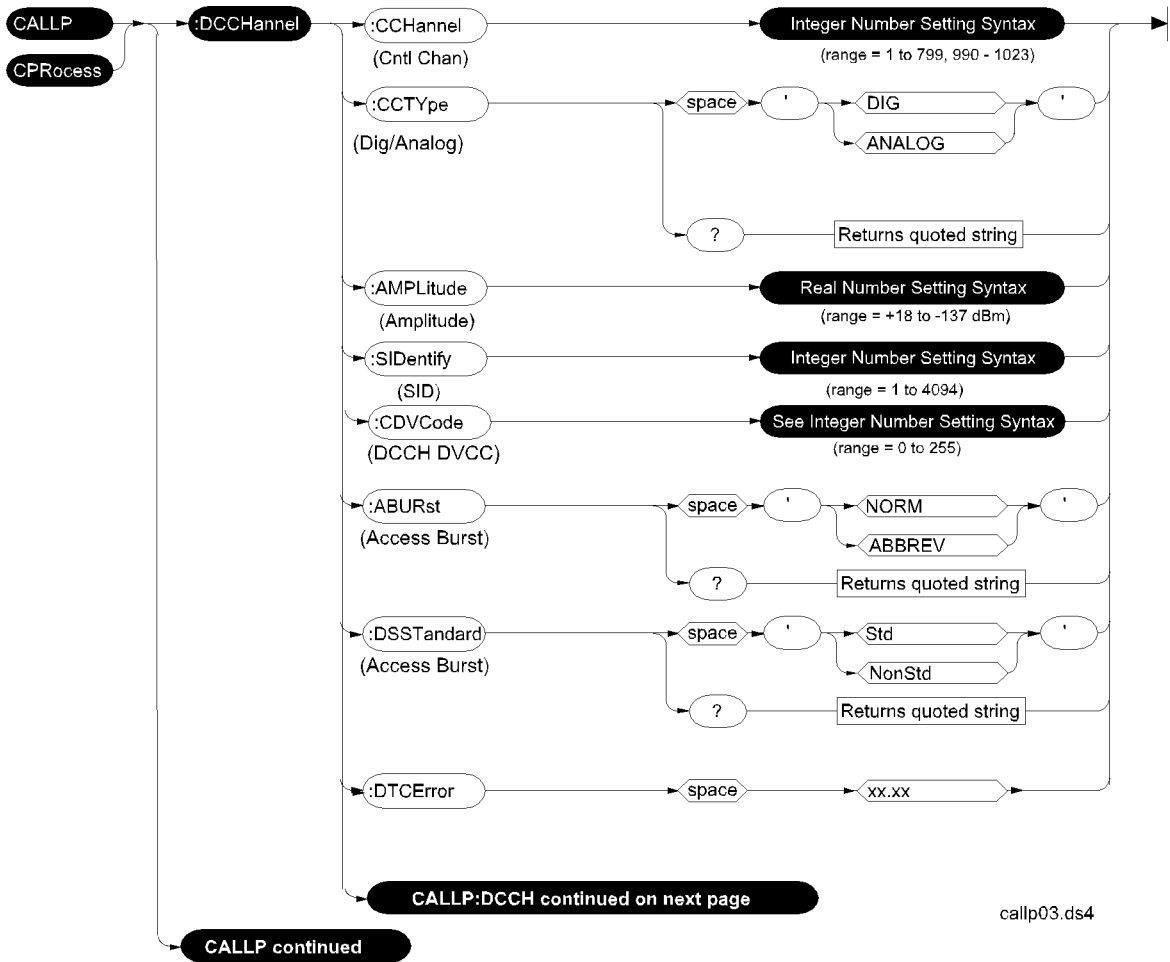

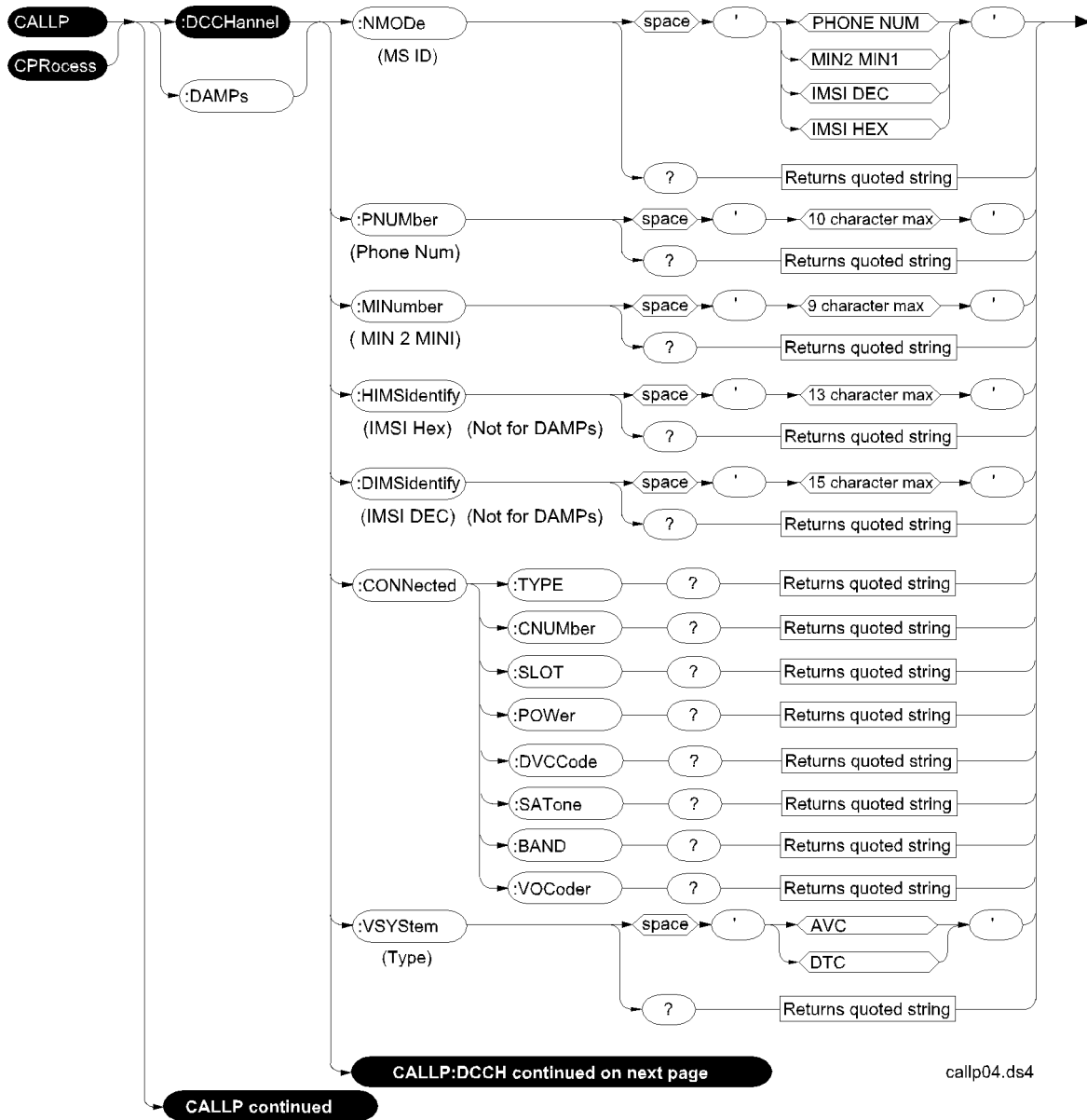

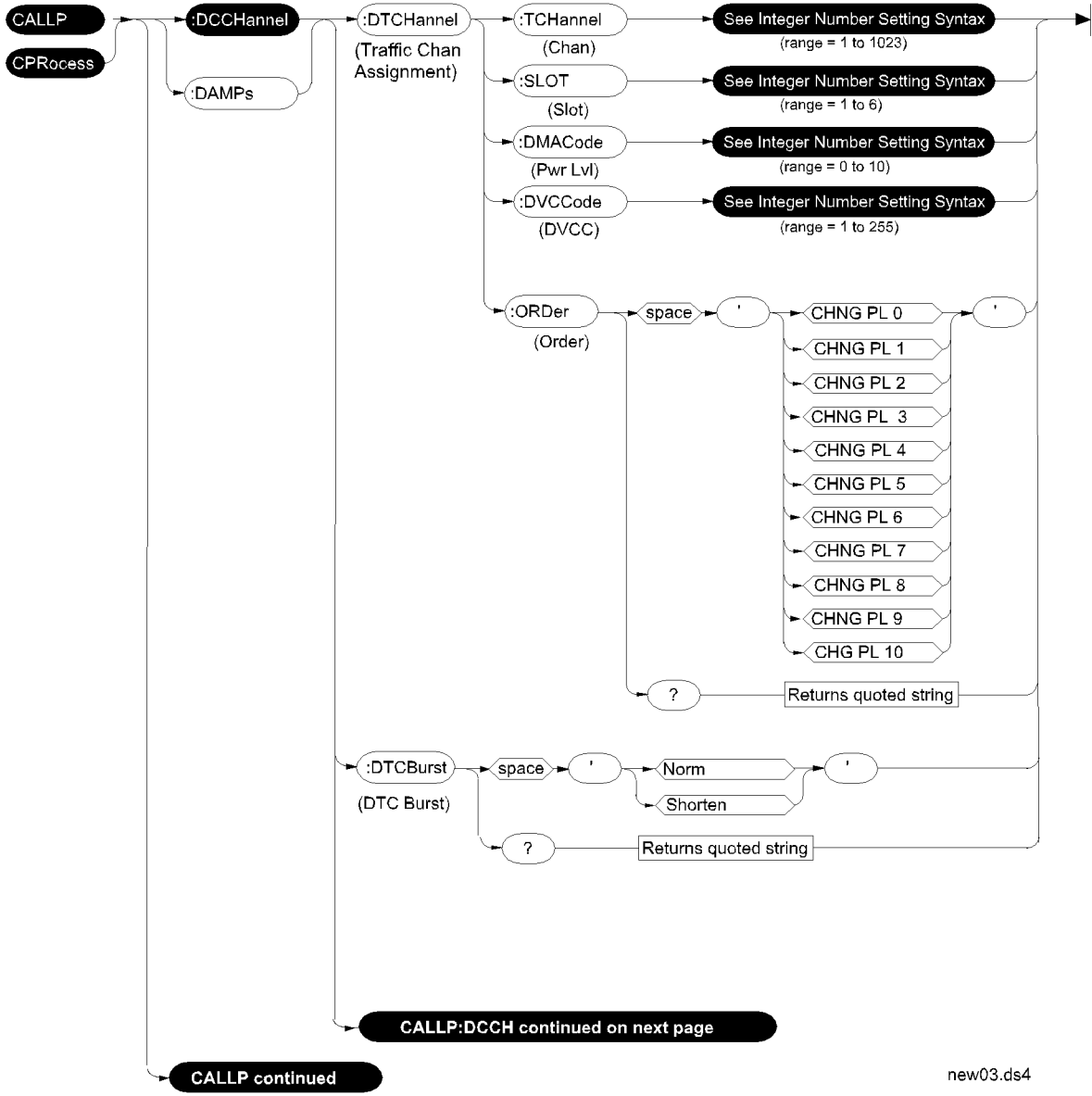

new03.ds4

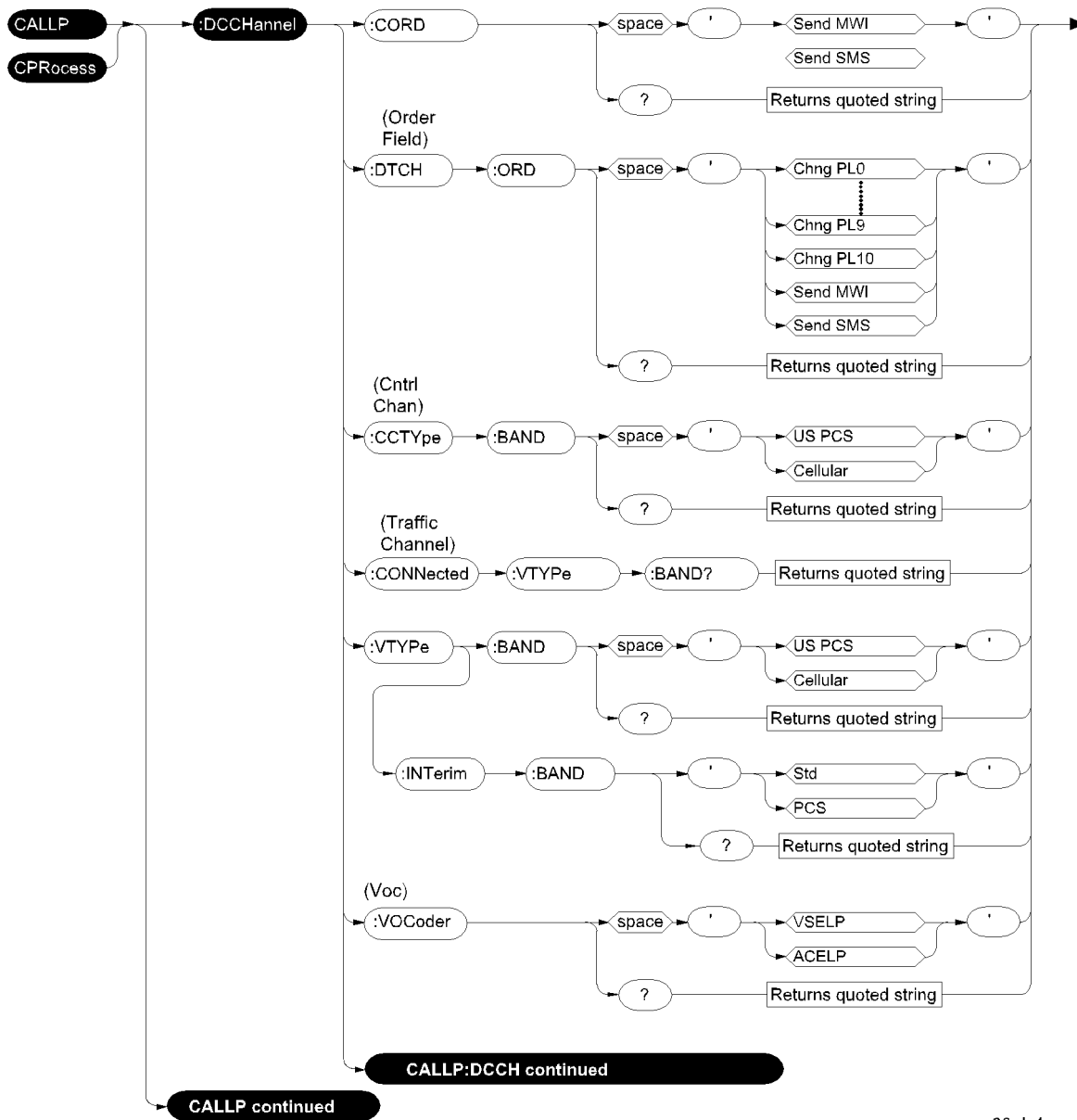

new38.ds4

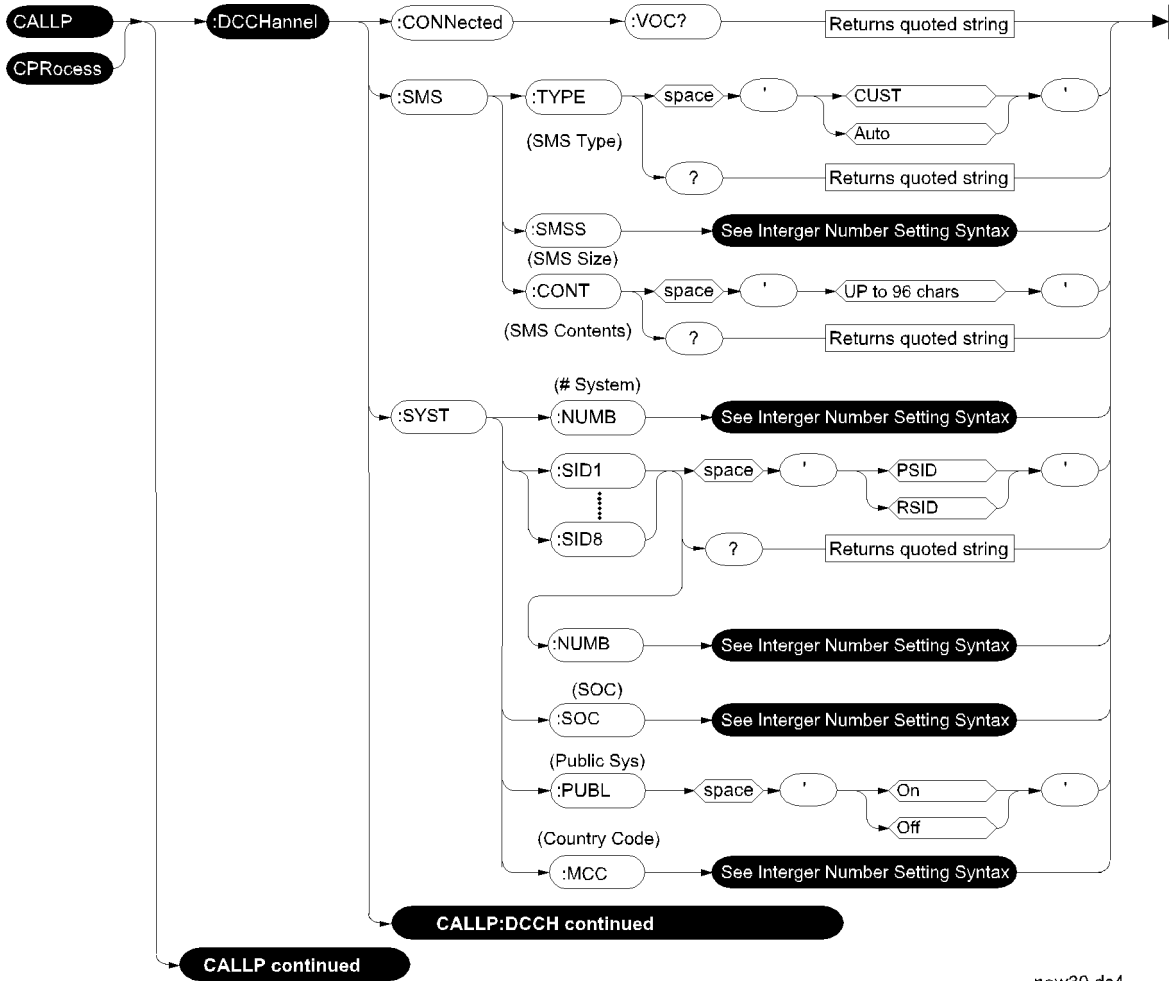

new39.ds4

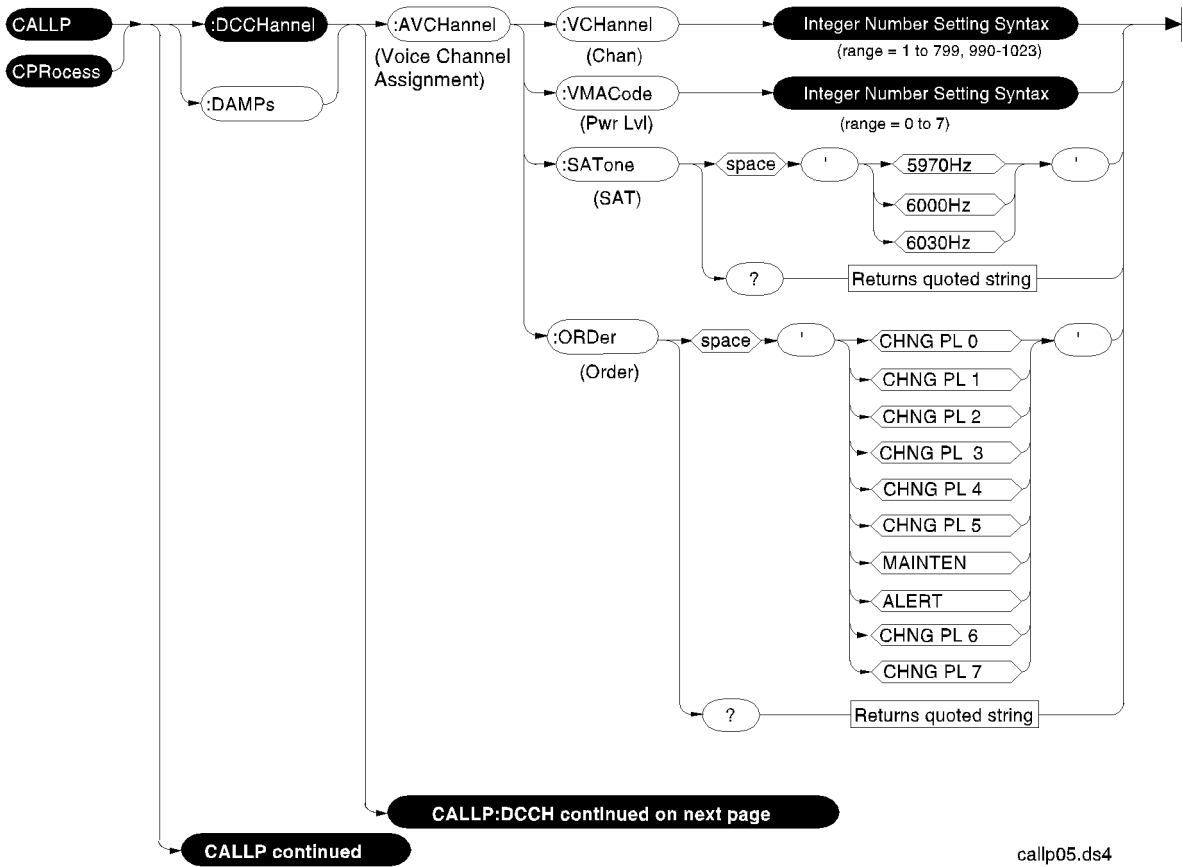

callp05.ds4

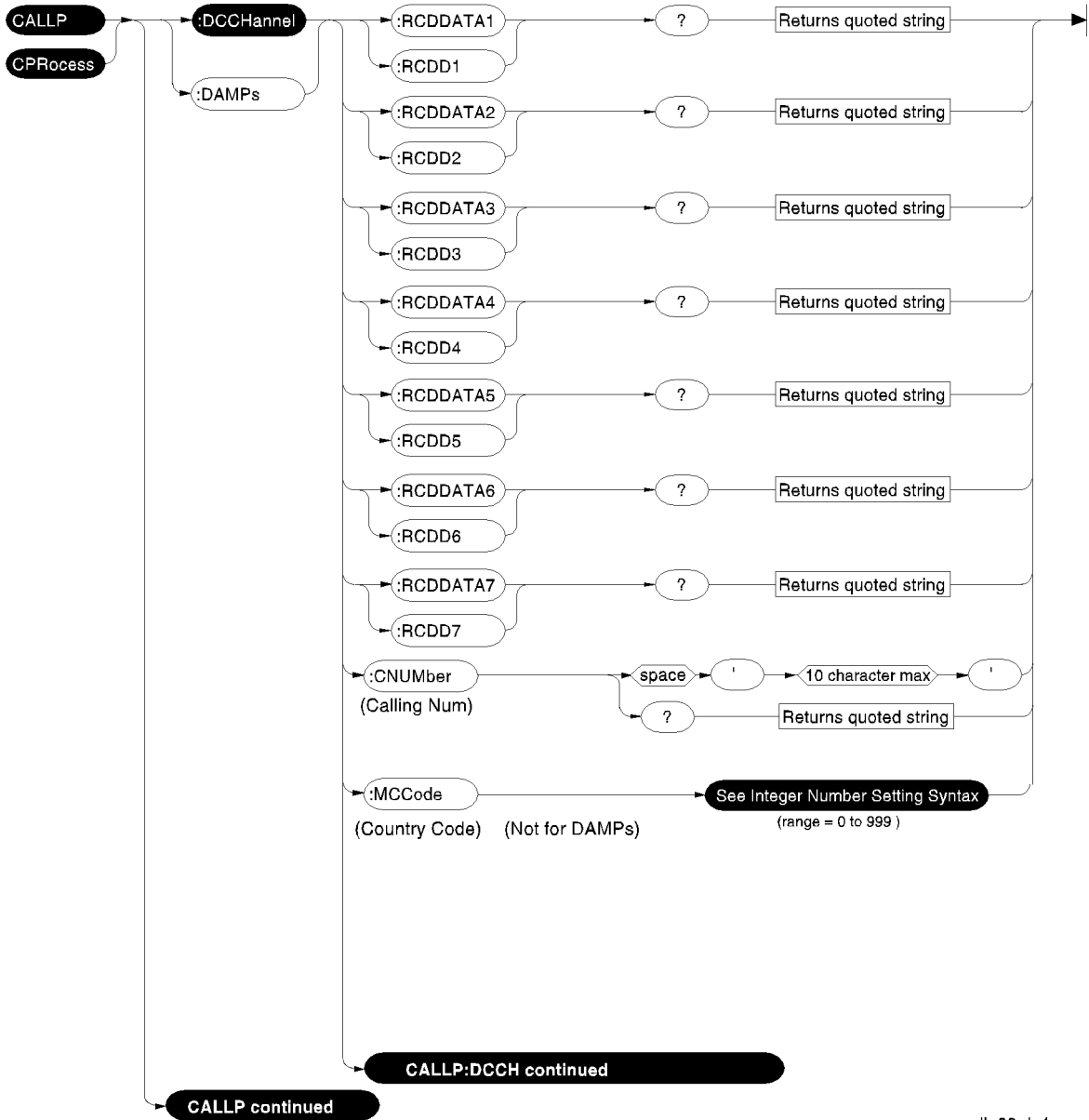

callp06.ds4

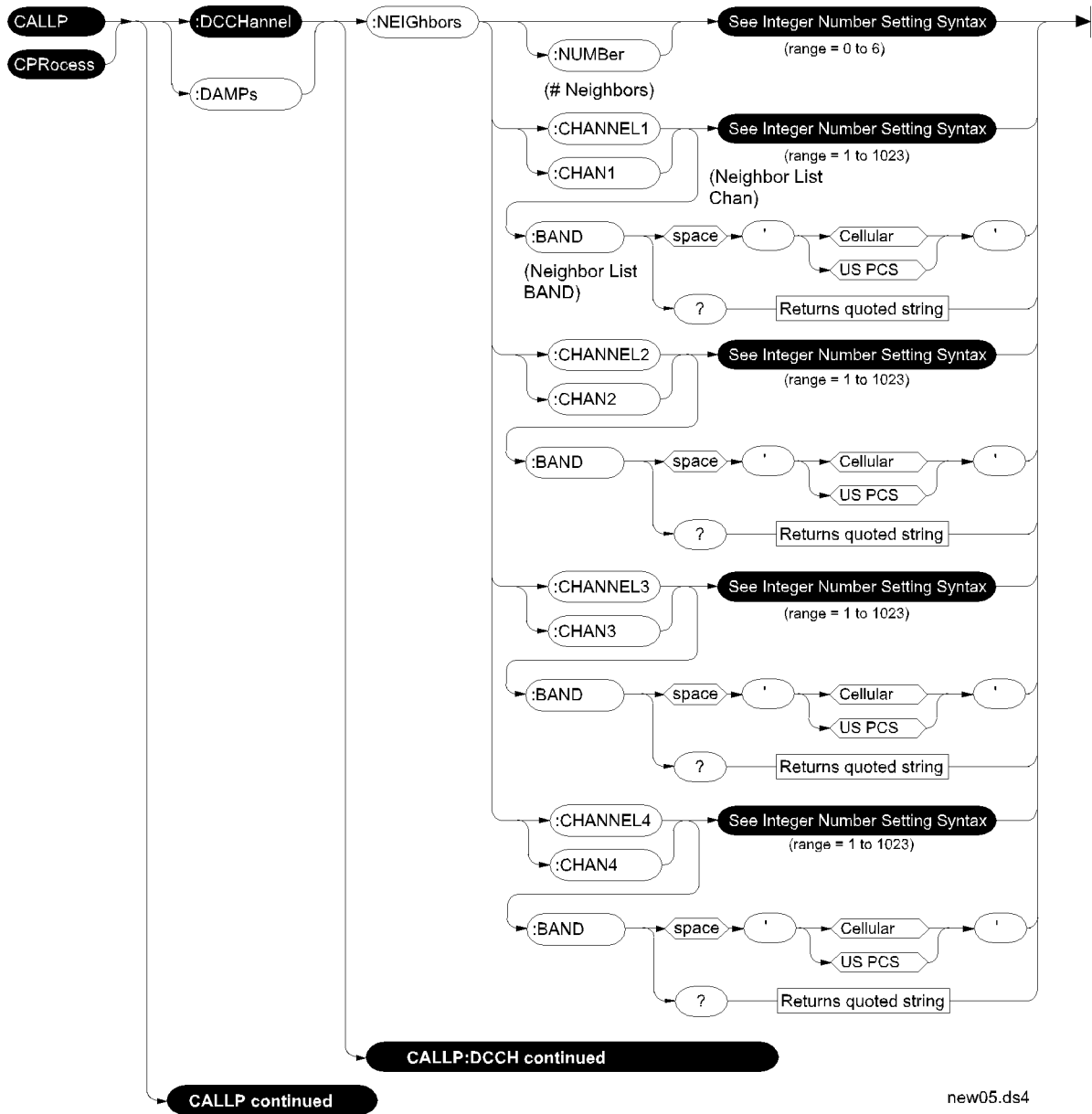

new05.ds4

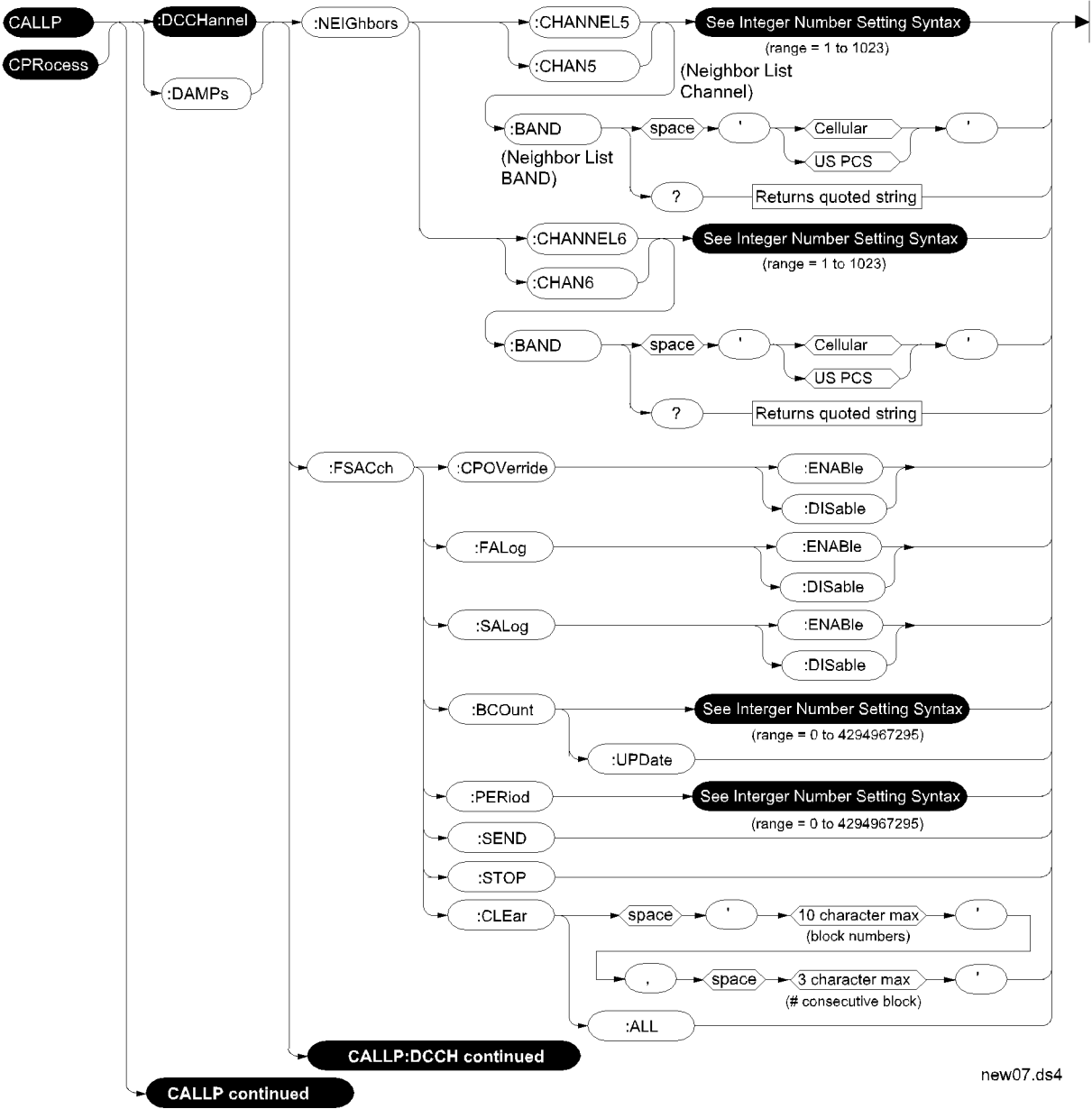

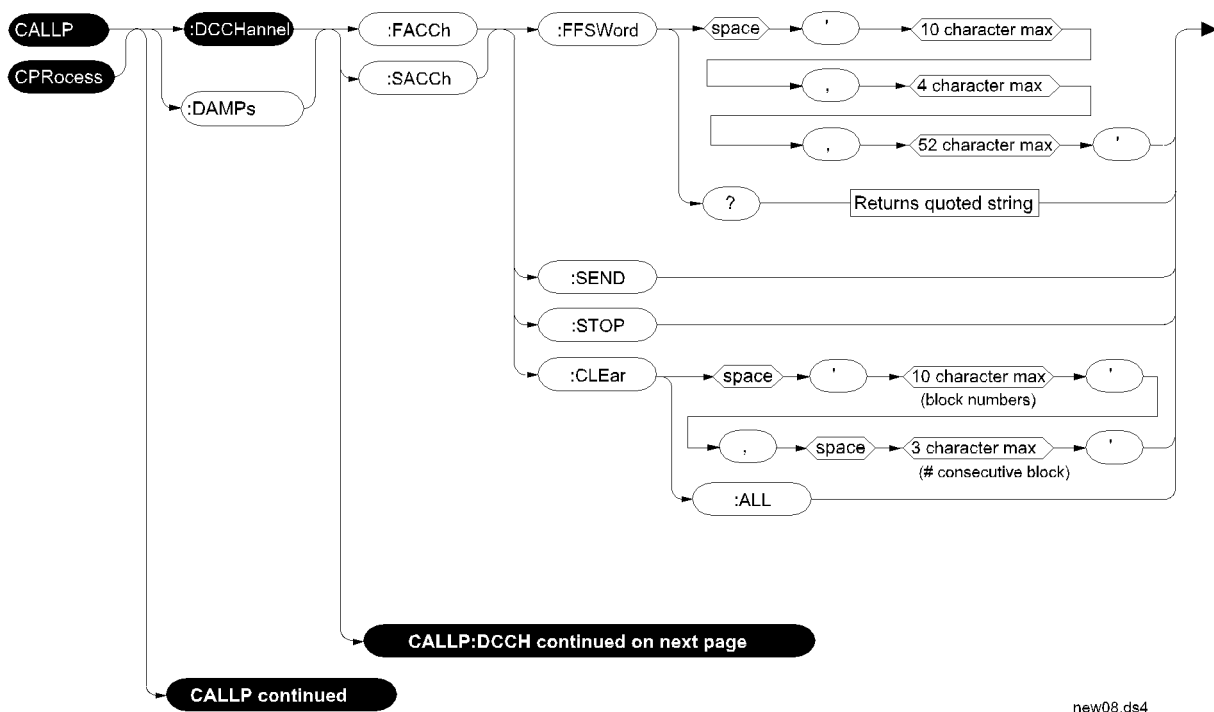

new08.ds4

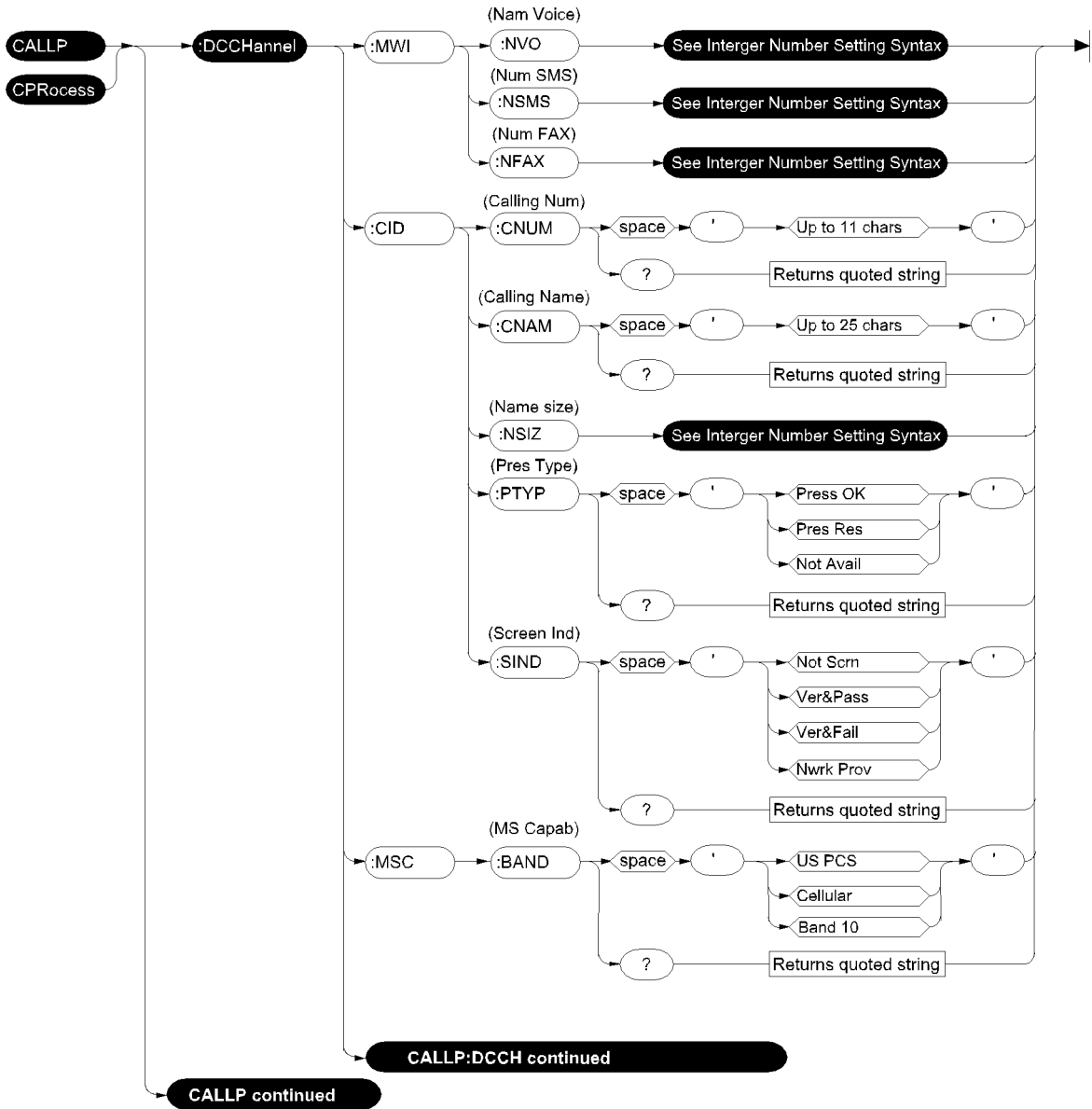

new42.ds4

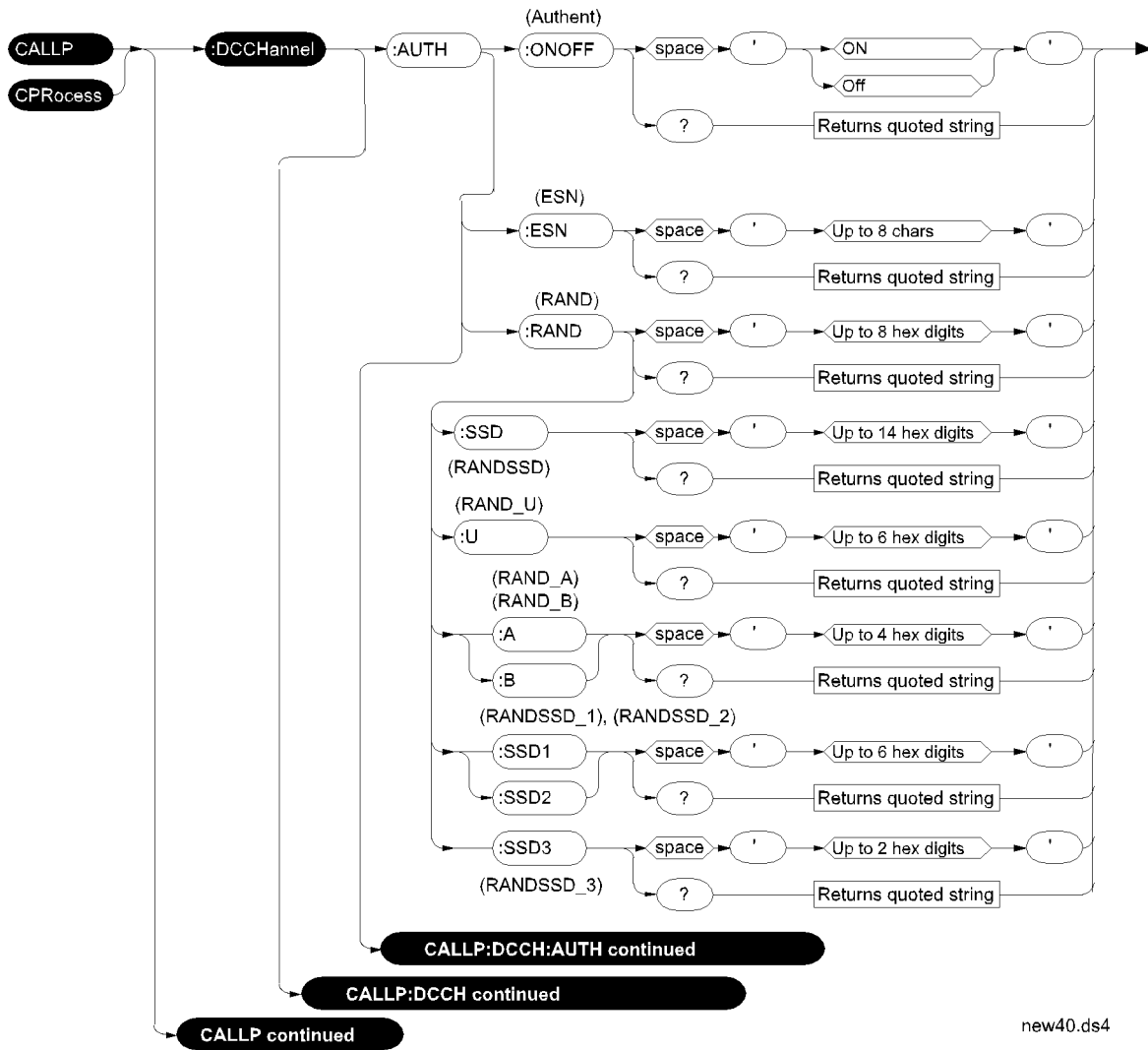

new40.ds4

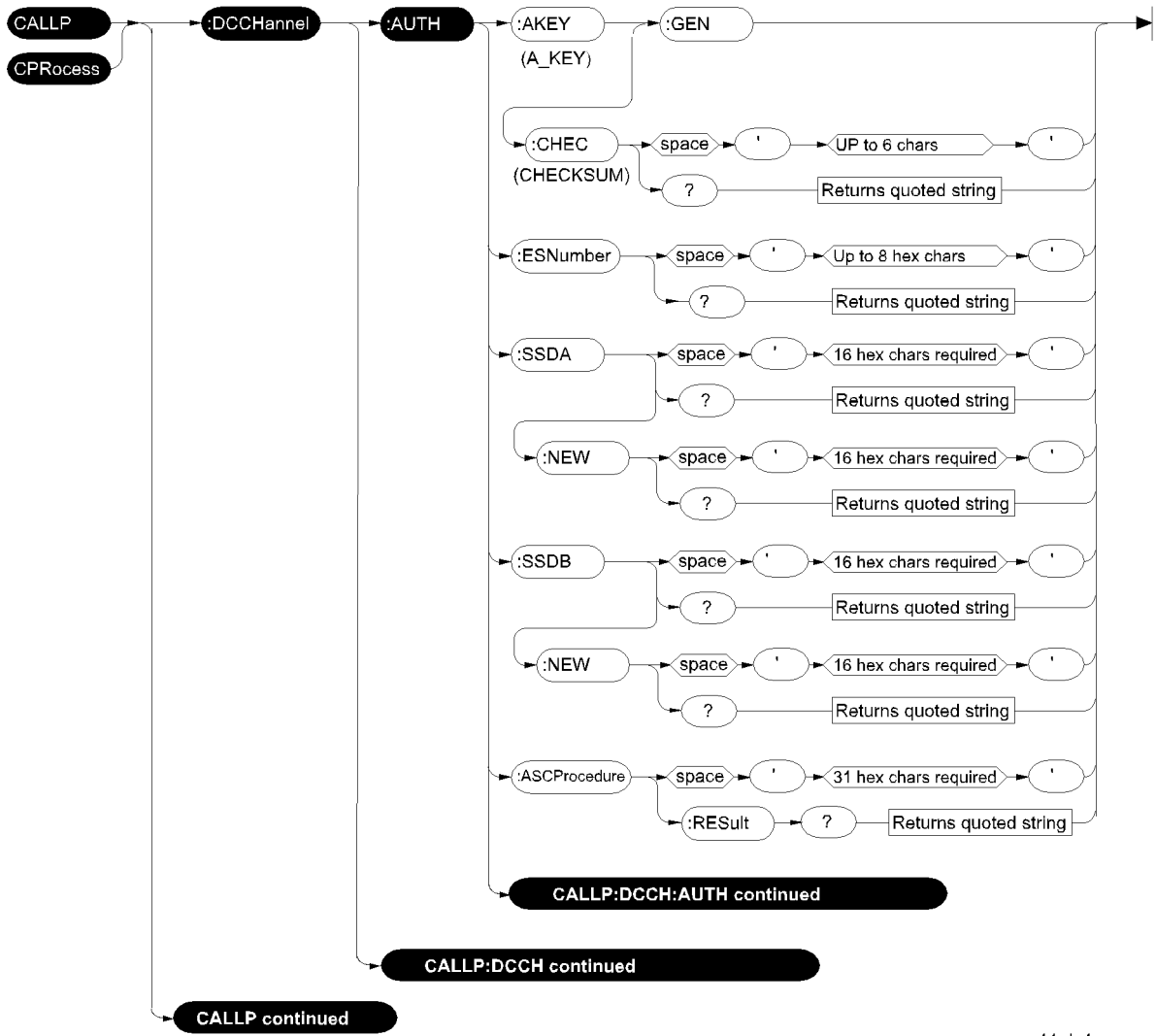

new41.ds4

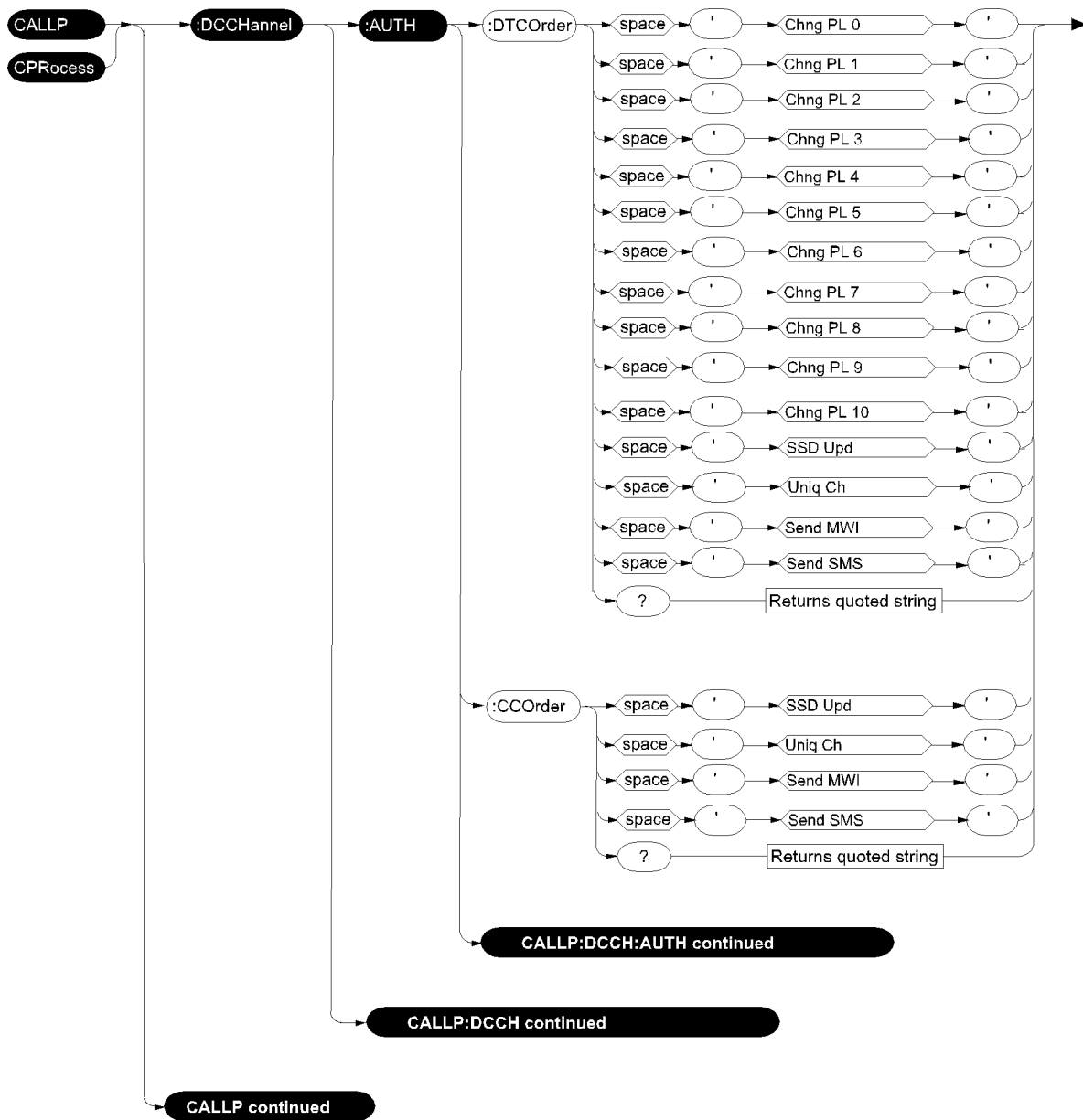

author:dr.ds4

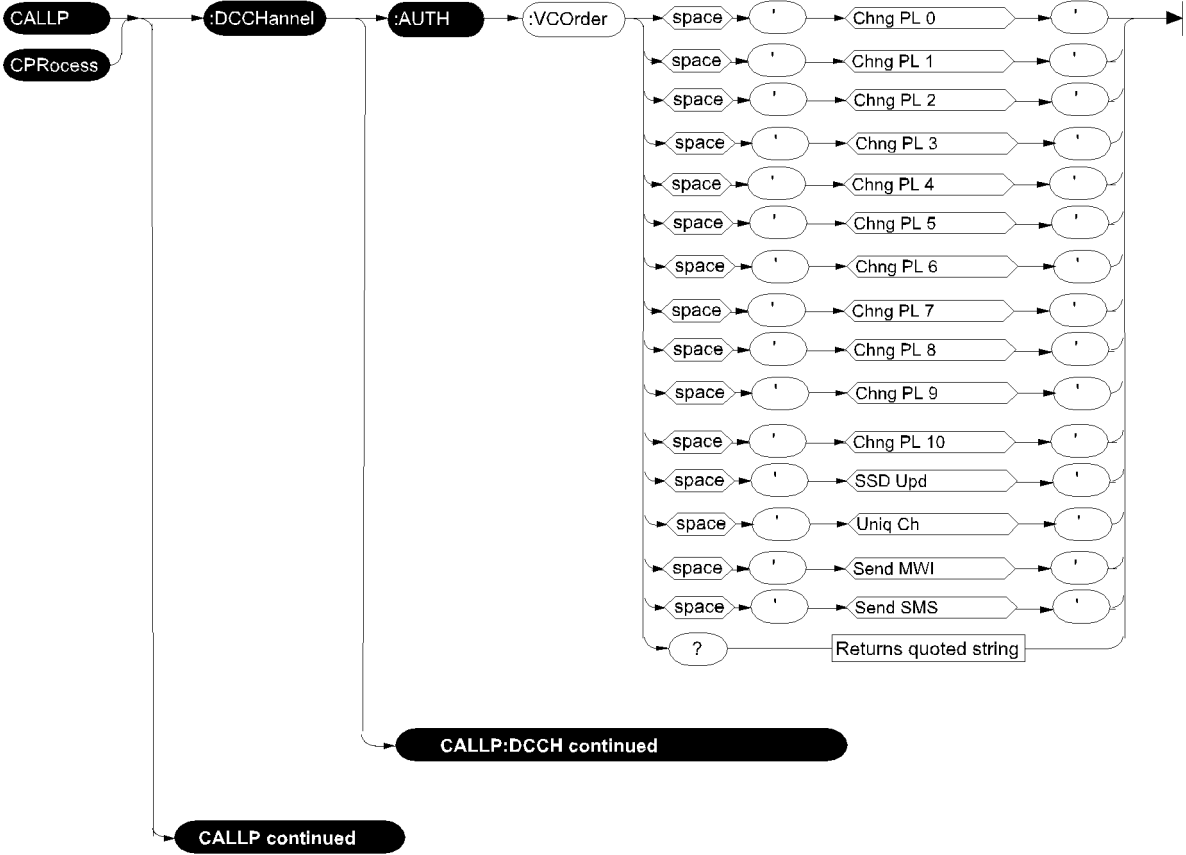

authord2.ds4

RF Path Control The syntax for the **RF Path** field (shown on the DCCH CALL CONFIGURE screen) uses a different root path than the other DCCH or DAMPs syntax. This field is used by several types of cellular adapters, and is therefore a more 'generic' control than the specific DCCH or DAMPs syntax.

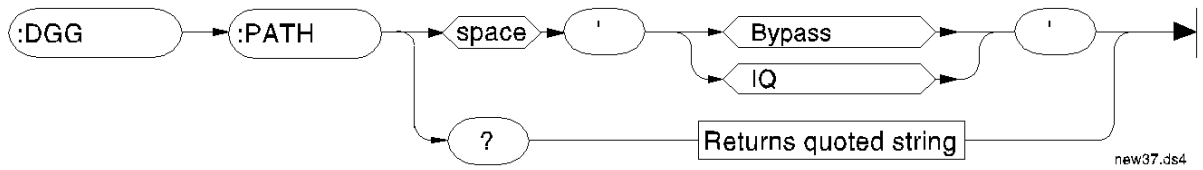

Meas

This subsystem has commands that are common to all Test Set applications. These are described in the *HP 8920 RF Communications Test Set Programmer's Guide*. Measurement commands that are specific to the testing of the TIA/EIA-136 system are shown in this section.

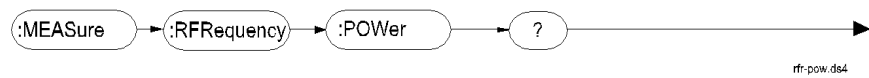

This command is used to measure RF power when a PCS Interface is connected and enabled.

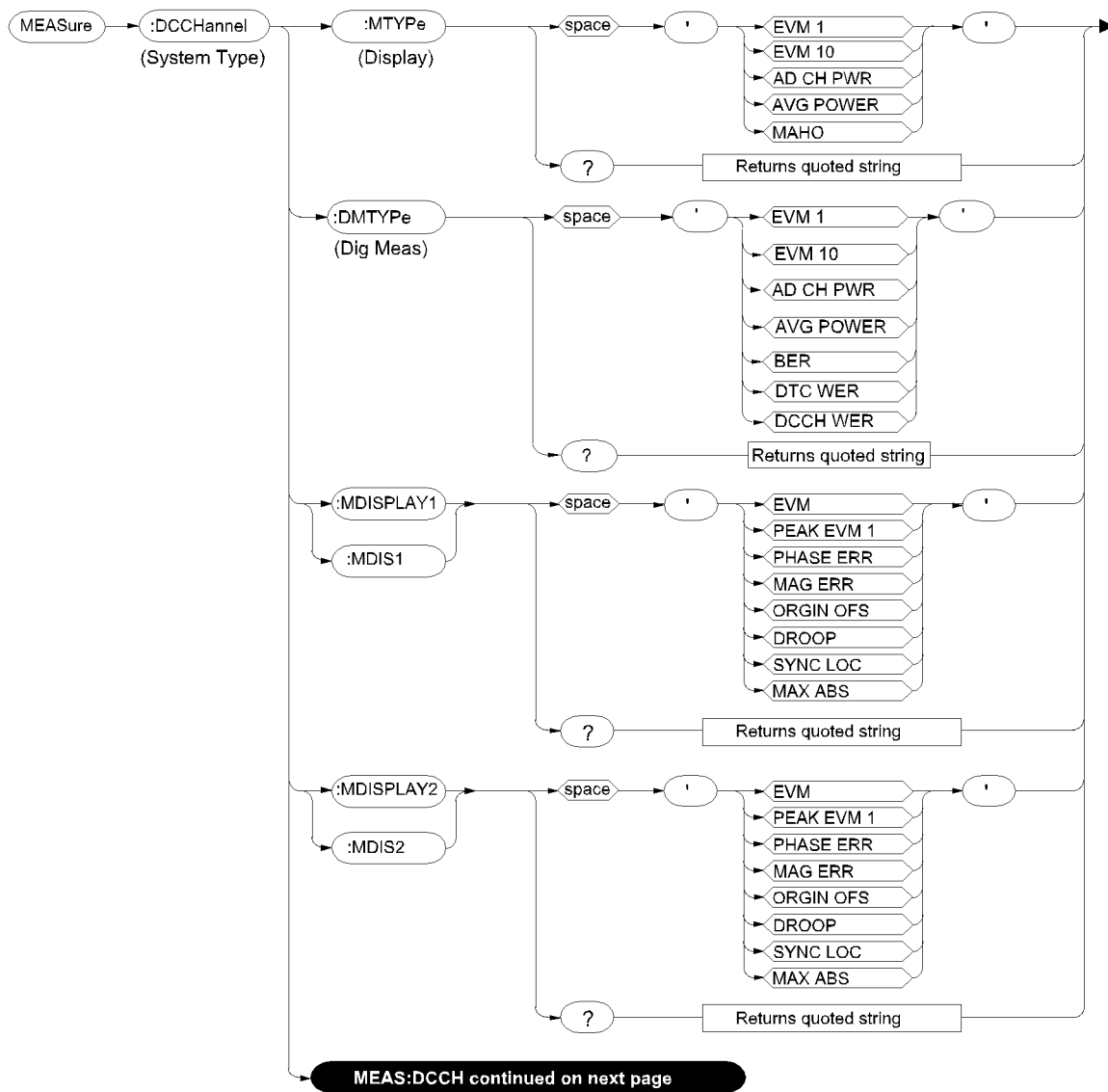

ch3drw34.ds4

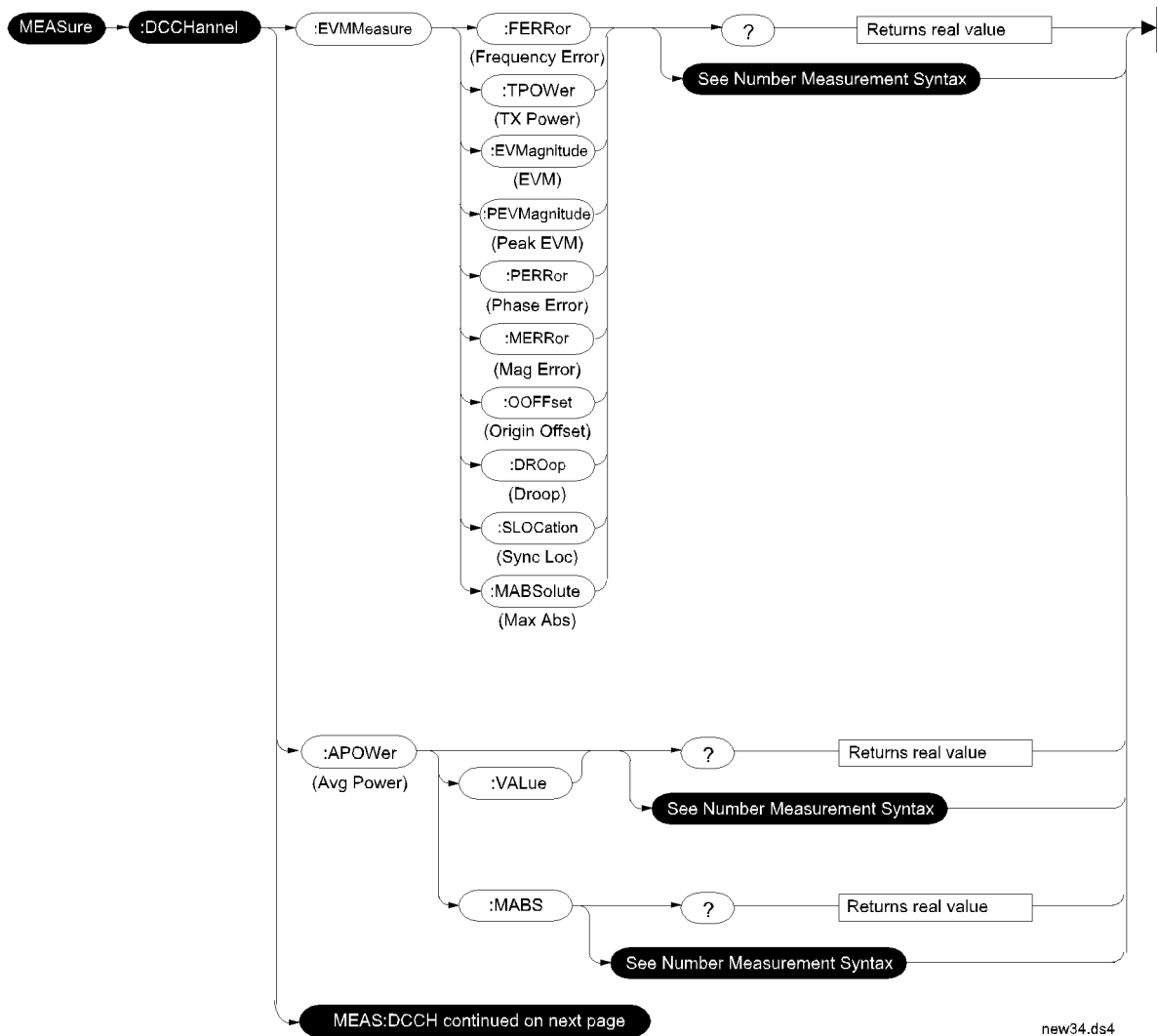

new34.ds4

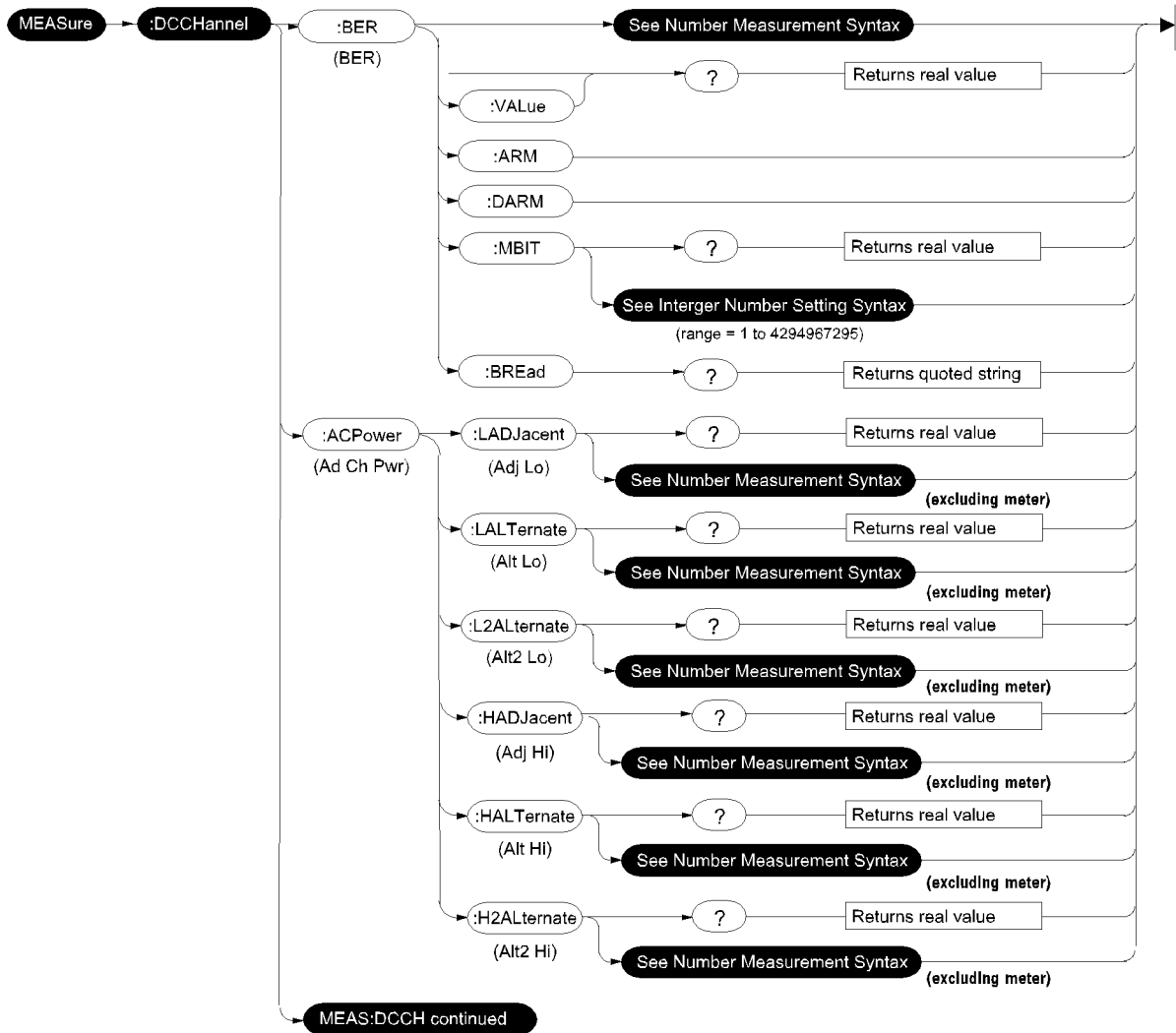

ch3drw35.ds4

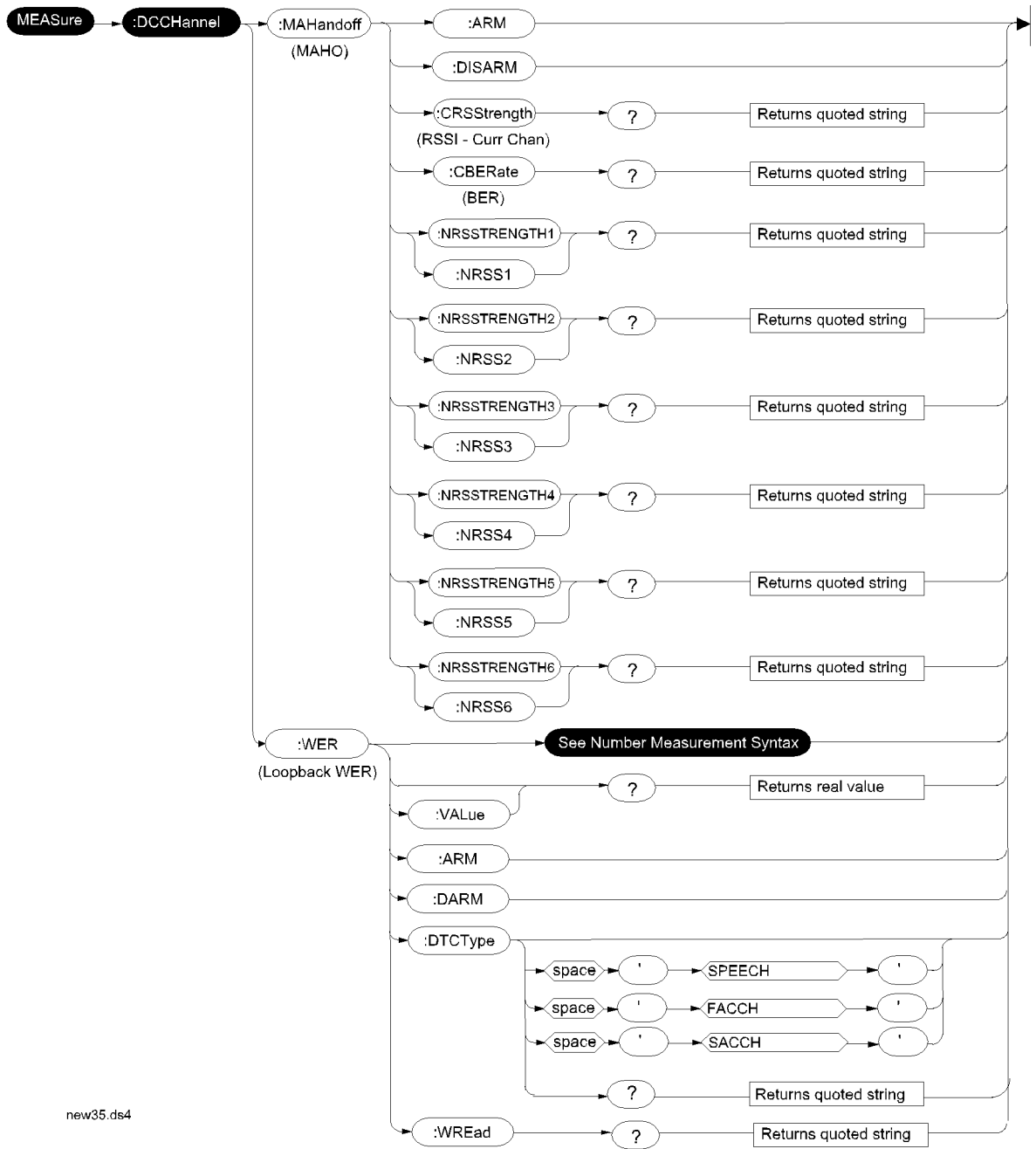

new35.ds4

SERV

The following commands are used to query some of the service latches in the test set. Not all of the latch commands are shown.

Querying the Timebase Out-of-Lock Indicator

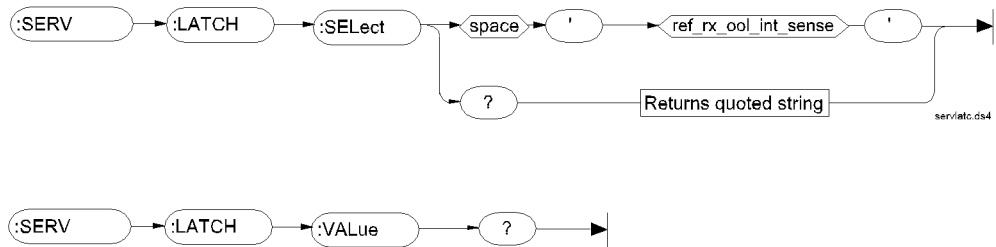

Issue the `:LATCH:SEL` command first, specifying the reference sense latch as shown above. Then use the `:LATCH:VAL?` query to see the status of the out-of-lock indicator. 0=locked, 1=out-of-lock.

Checking if Temperature Compensation is Necessary

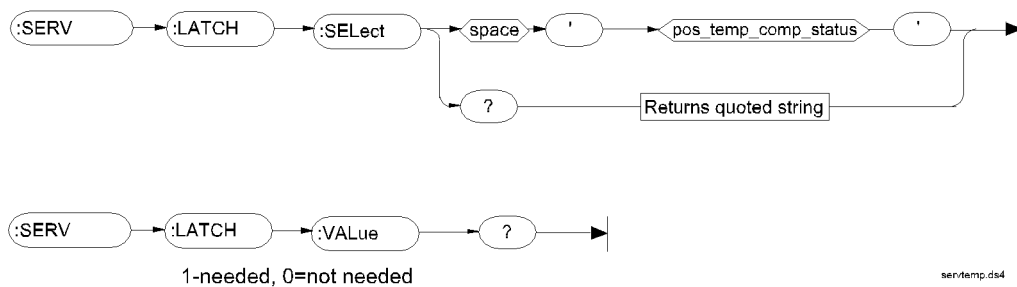

Integer Number Setting Syntax

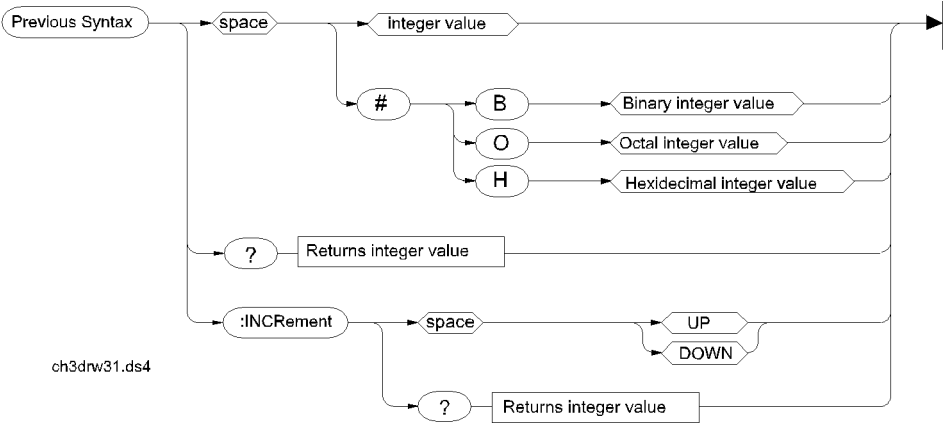

Real Number Setting Syntax

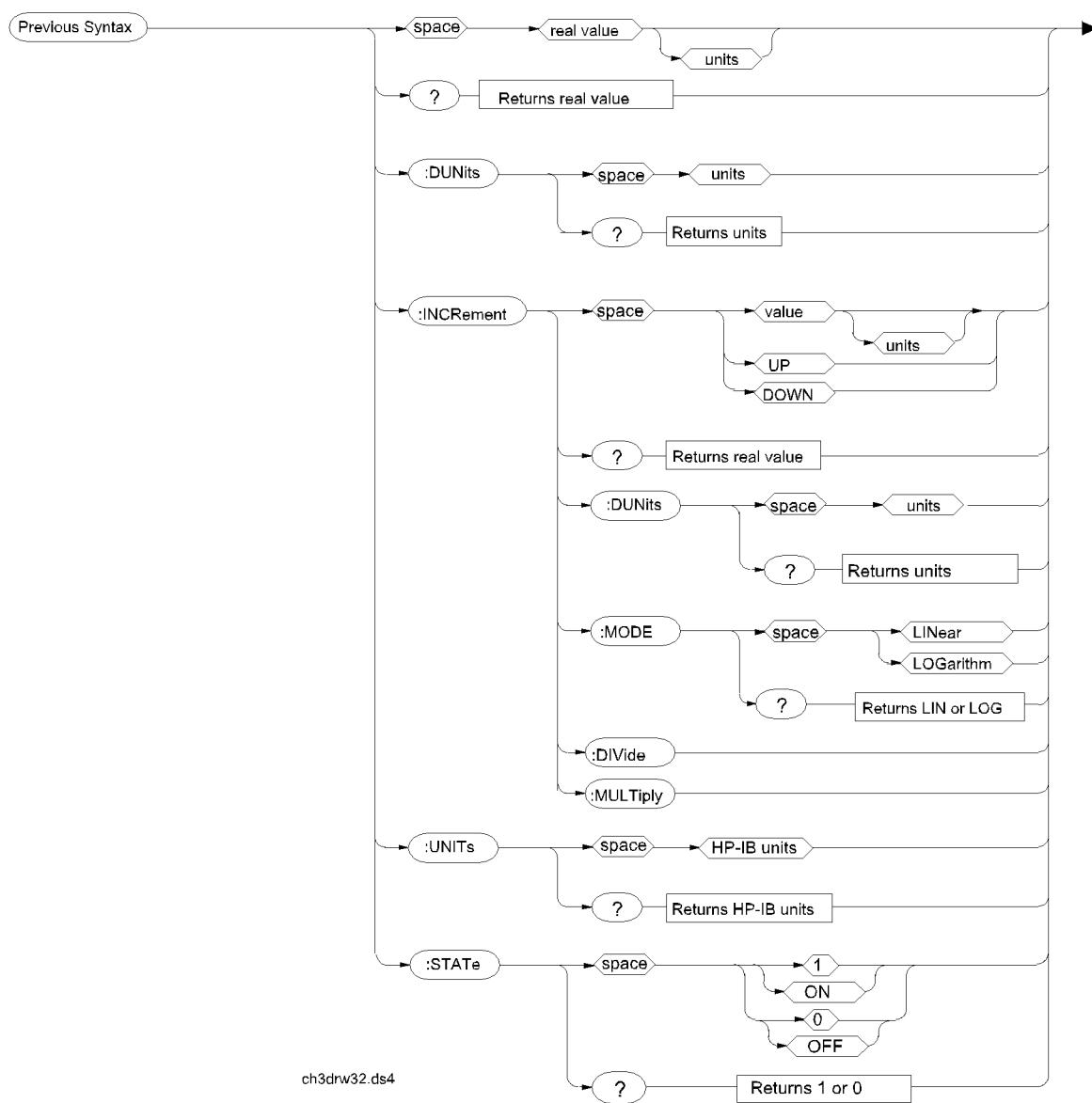

Multiple Real Number Setting Syntax

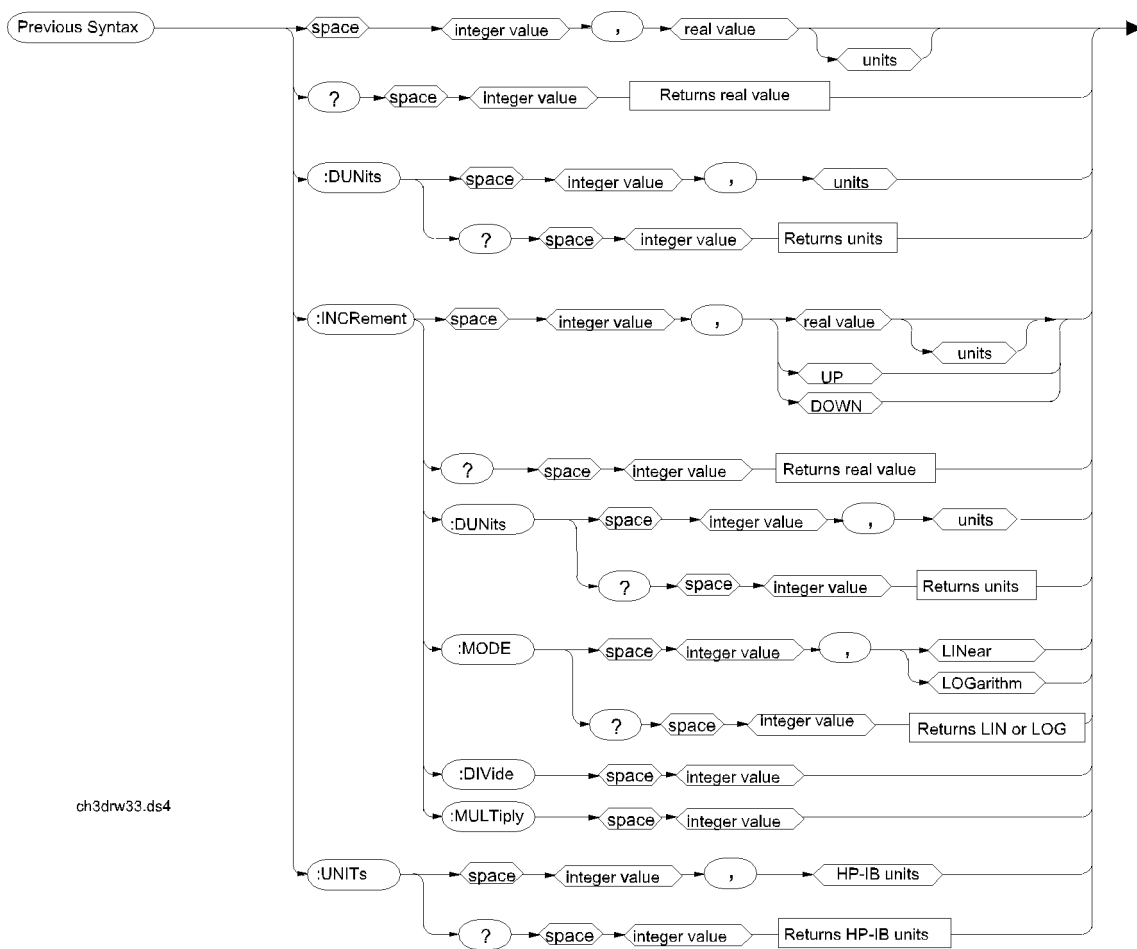

ch3drw33.ds4

Number Measurement Syntax

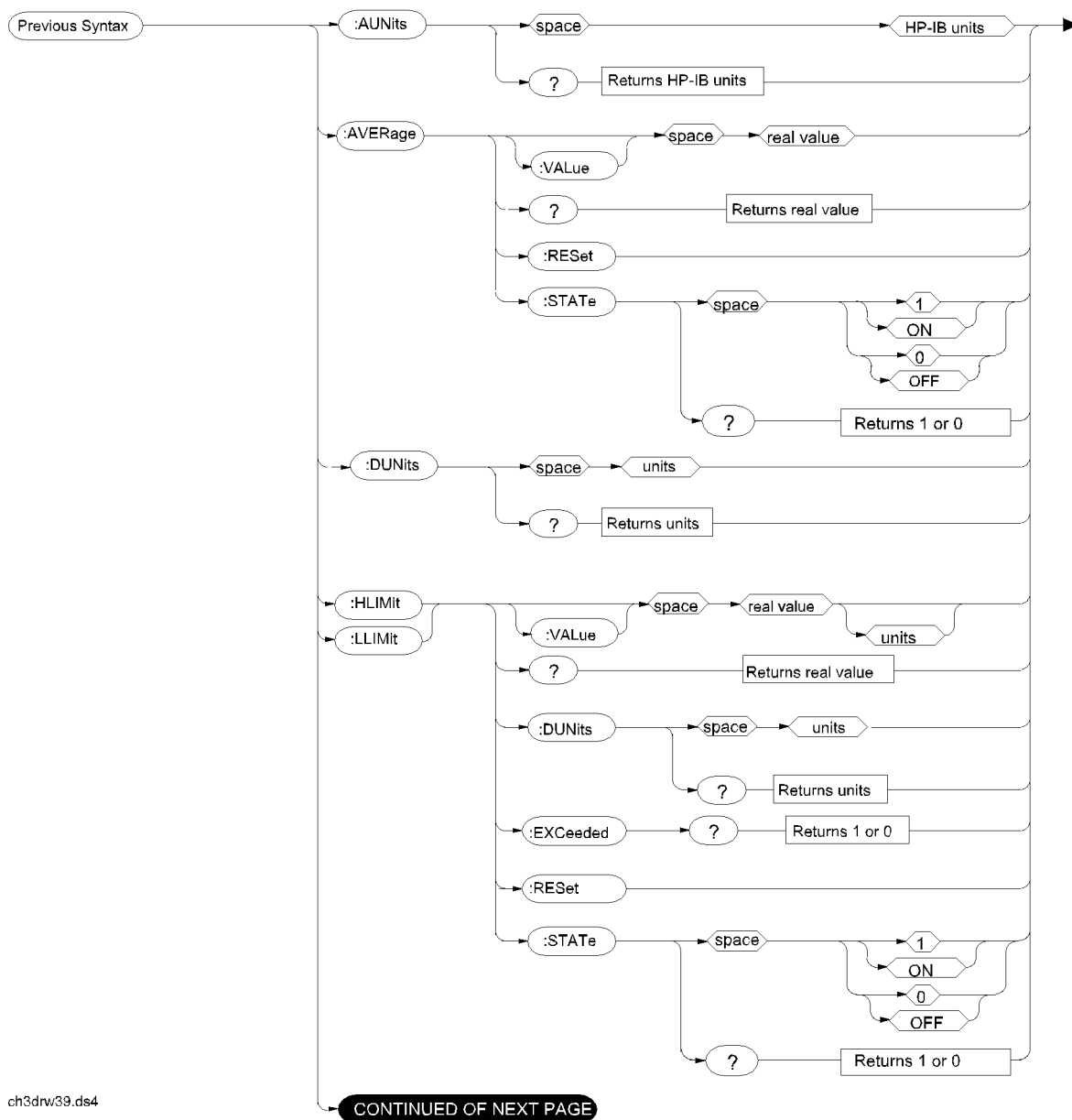

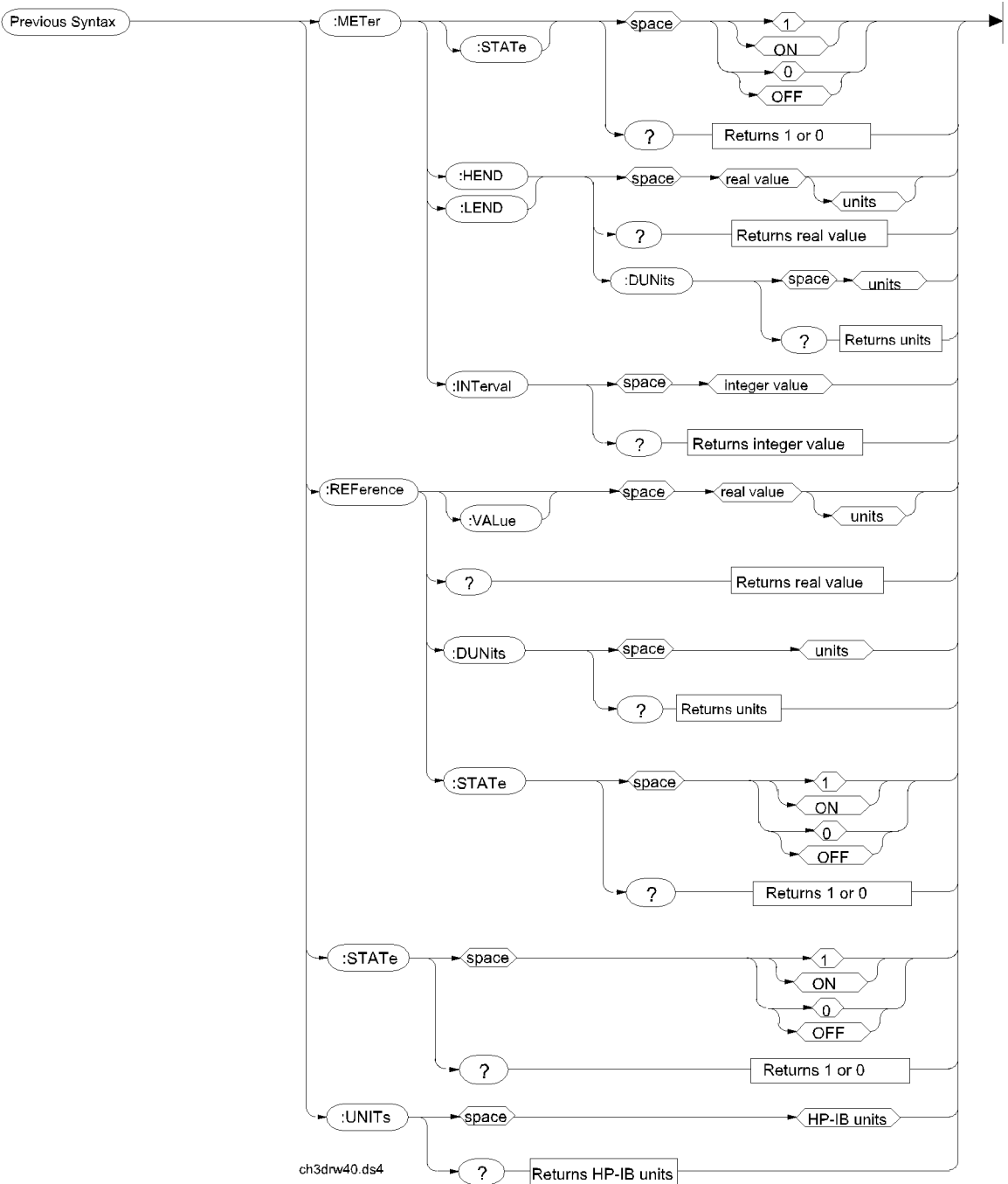

ch3drw40.ds4

Multiple Number Measurement Syntax

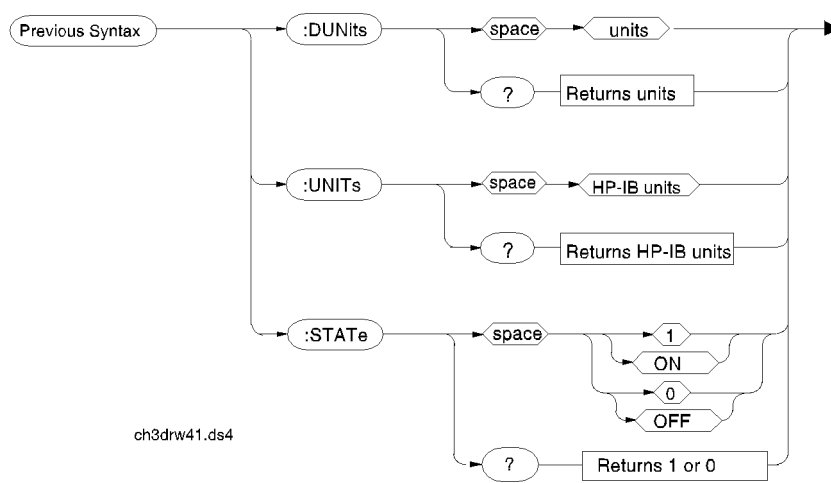

Screen and Field Descriptions

This chapter identifies each screen provided by this Cellular Adapter. It also provides detailed information on the fields within each screen. It is organized by screen, and the list of fields for each screen is organized in alphabetical order.

The DCCH Call Processing Screens

The main screen for this Cellular Adapter is the CALL CONTROL screen. You can access the CALL CONTROL screen from any of the main HP 8920 screens (RX Test, TX Test, and so on). You must be in the CALL CONTROL screen with System Type DCCH to access the other screens available for TIA/EIA-136.

The CALL CONTROL screen controls the TIA/EIA-136 call setup and maintenance functions. It also displays the data and measurements available. See [“About Call Processing Tasks and Measurements” on page 62](#) for more information.

The DCCH CALL CONFIGURE screen provides additional controls for TIA/EIA-136 features. See [“CALL CONFIGURE Screen” on page 54](#) for more information.

The DCCH CALL CONFIGURE II screen provides controls to define TIA/EIA-136 message waiting indicators and caller ID features.

The DIG MEAS and ANL MEAS screens are available for special measurements of TIA/EIA-136 mobiles. See [Chapter 4, “Making Measurements,” on page 4 99](#) for more information.

The AUTHENTICATION screen allows you to enter parameters for authentication into the Test Set. These parameters are used by the CAVE algorithm during Call Processing functions such as registration, page, and originate to verify a valid call.

DAMPS Call Processing

DAMPS call control is similar to DCCH call control; however, the DAMPS screen does not have a digital control channel selection, or vocoder selection, nor does it operate in the PCS band.

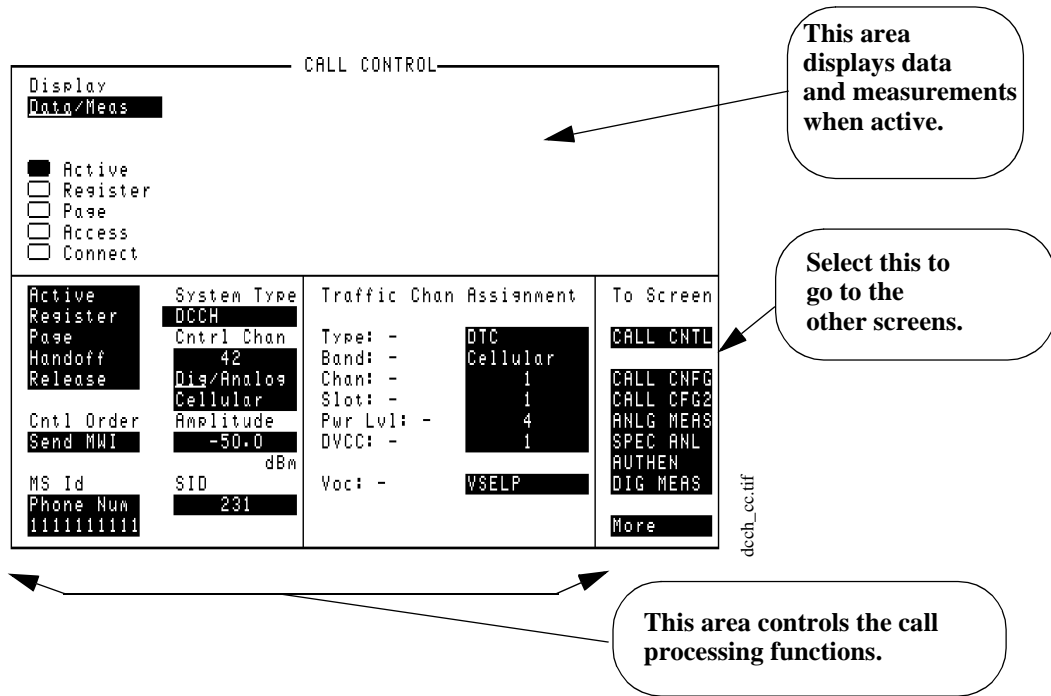

Figure 59 The CALL CONTROL Screen for the DCCH

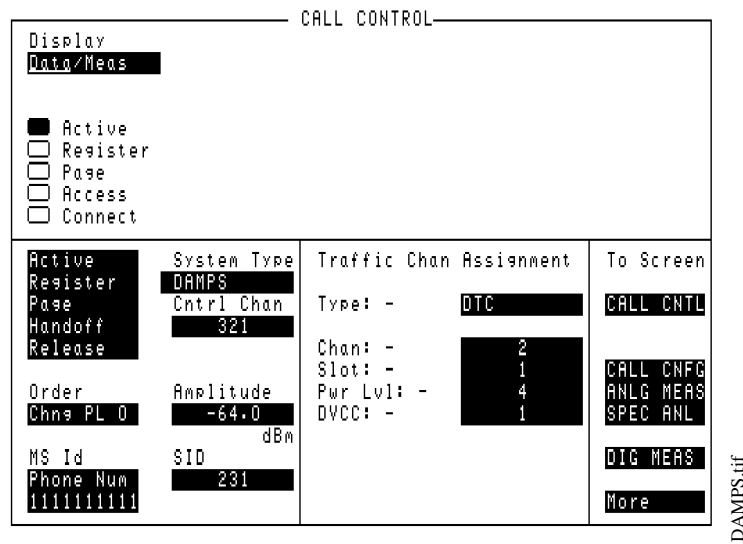

Figure 60 The CALL CONTROL Screen for DAMPS

Parameters of the CALL CONTROL Screen

Refer to “Programming the Call Processing Subsystem” in the *HP 8920B Programmer’s Guide* for detailed information on writing programs using the CALL CONTROL screen functions.

The following list describes the parameters available on the CALL CONTROL screen for DCCH. This list, which is in alphabetical order, has the following format:

- Parameter name** Settings:
 Units or number type (integer, real, and so on).
 Definition and description.

The CALL CONTROL screen

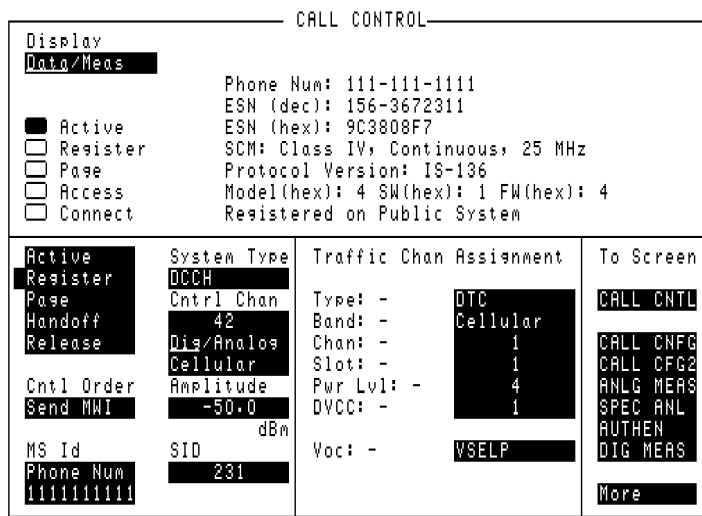

Registra.tif

Figure 61 **The CALL CONTROL Screen**

Access Settings: On or Off
Units: None.

Access is an annunciator. It indicates that the Test Set and the mobile are in communication, usually while setting up a call.

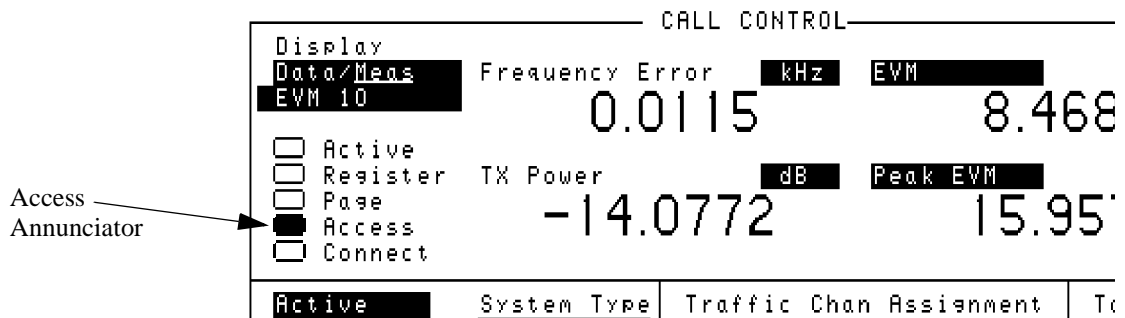

Figure 62 The Access Annunciator Display (CALL CONTROL Screen)

Active Settings: This is an immediate action field. Selecting it starts the action, an annunciator indicates On or Off status.

Units: None.

Active is both an annunciator and a command. This command instructs the Test Set to emulate a base station. The annunciator indicates that the Test Set is ready to perform base station functions.

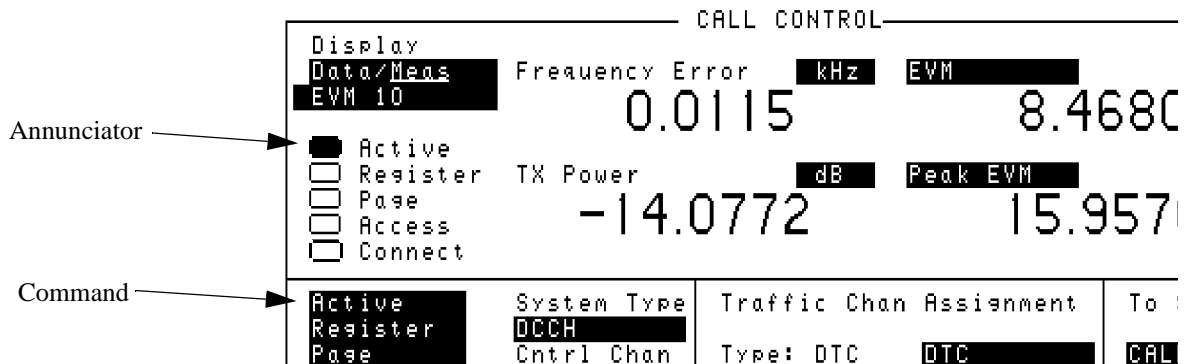

Figure 63 The Active Command and Annunciator Display (CALL CONTROL Screen)

Amplitude	Settings: -137.0 through +18.0 Units: dBm. The amplitude of the RF signal that the Test Set will transmit. Note that the available setting is greater than both the specified maximum output power of the Test System and the system specification as well. This is done to allow you to use the maximum output power of each individual Test Set.
Band	Settings: Cellular or US PCS Units: None The channel band assignment of the traffic channel.
CC Order	Settings: SSD Upd, Uniq Ch, Send MWI, Send SMS Units: None This field is only displayed when Authentication is turned on, and with the mobile <i>not</i> in the connect state. It allows you to send a shared secret data update, unique challenge, message waiting indicator, or short message services command to the mobile. See also, “Which Control Order Command Should I Use?” in the <i>HP 8920B Option 801 Condensed Programming Reference</i> .
Chan	Settings: 1 through 799, 990 through 1023 (Cellular); 1 through 1999 (US PCS) Units: None, Integer values. The channel number of the voice or traffic channel.
Connect	Settings: On or Off Units: None. Connect is an annunciator. It indicates that the Test Set and the mobile are in Connect state (a call is up).

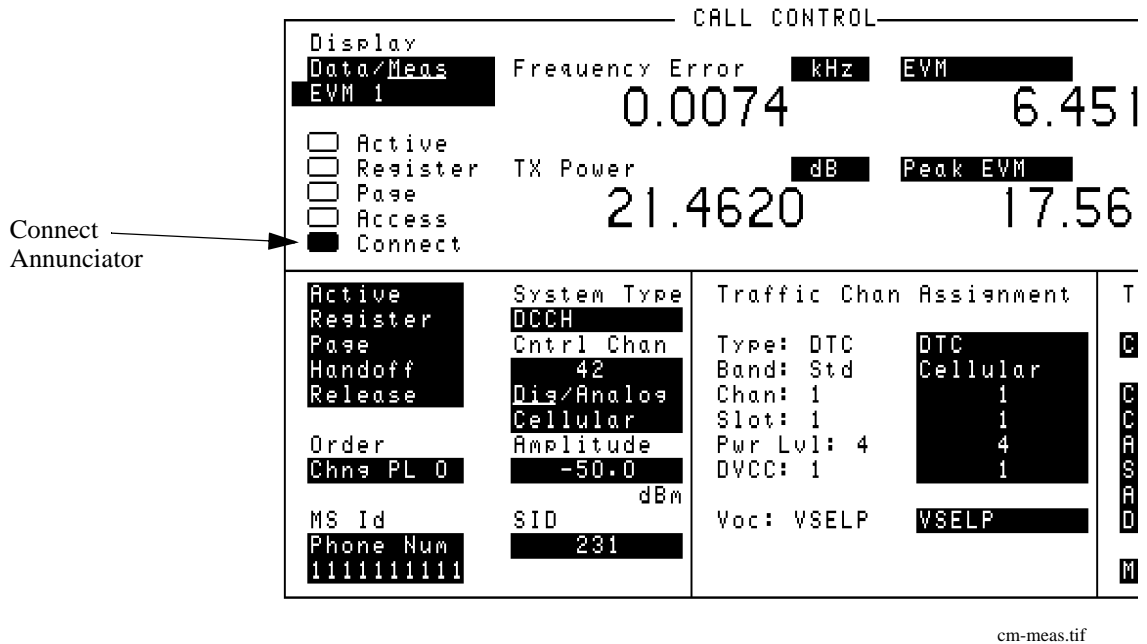

Figure 64 The Connect Annunciator Display (CALL CONTROL Screen)

Cntl Order

Settings: Send MWI (Message Waiting Indicator) or Send SMS (Short Message Services).

Units: None

Send a message waiting indicator or short message to the mobile when not in the connect state. The field name is changed to **CC Order** if Authentication is turned on. The field name is changed to **Order**, and the choices are changed, when the mobile is in the connect state.

See also, "Which Control Order Command Should I Use?" in the *HP 8920B Option 801 Condensed Programming Reference*.

Cntrl Channel

Settings: 1 through 799, 990 through 1023 (Cellular); 1 through 1999 (US PCS); Dig or Analog

Units: None, Integer values only

Screen and Field Descriptions

Display

Settings: Data, Meas (this is a toggle field)

Units: None.

This is a toggle field. When Meas has been selected, another field appears below the **Data/Meas** field. This new field provides a list of measurements which can be made.

Measurements available in this list are:

- EVM 1
- EVM 10
- Adjacent Channel Power
- Average Power
- MAHO

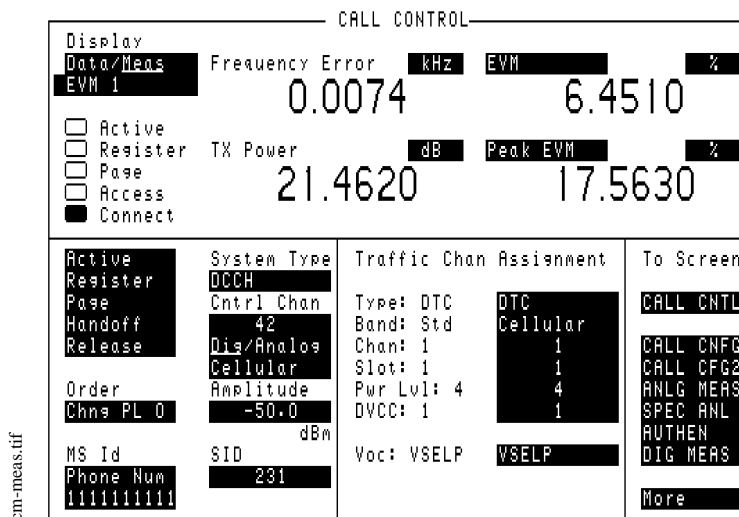

Figure 65 The Data/Meas Field Display (CALL CONTROL Screen)

DVCC

Settings: 1 through 255

Units: None, Integer values.

Digital Verification Color Code. This is for the DTC only. For the DVCC of the DCCH, see “Parameters of the DCCH CALL CONFIGURE Screen” on page 220.

Handoff

Settings: This is an immediate action field. Selecting it starts the action.

Units: None.

Handoff is a command. It instructs the Test Set to make a handoff, based on the new channel's parameters (determined in the **Traffic Chan Assignment** settings).

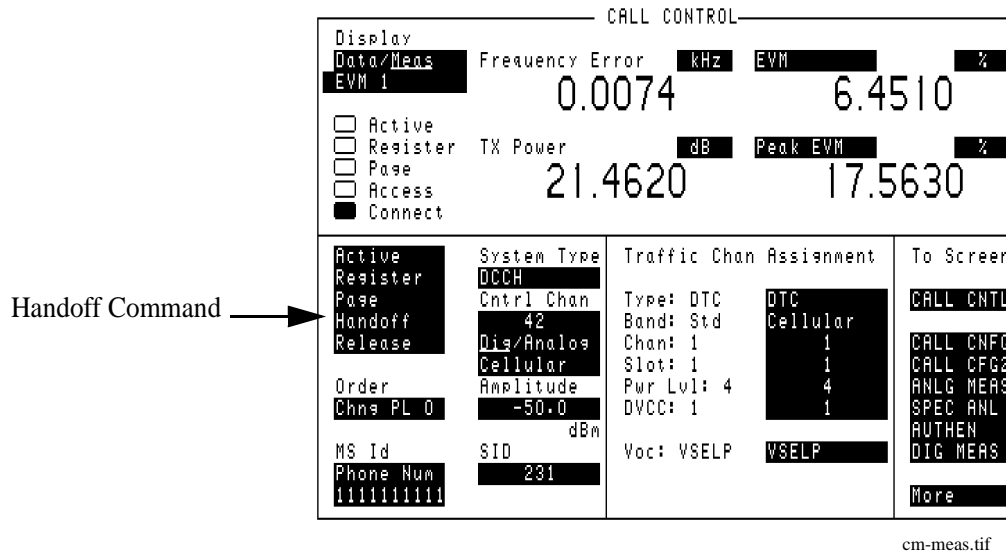

Figure 66 The Handoff Command Display (CALL CONTROL Screen)

MS ID

Settings: Phone Num, MIN2 MIN1, IMSI Dec, IMSI Hex

Units: Decimal or Hexadecimal values.

Mobile Station Identification. MSID is a two part field. The upper field determines what will be displayed, either Phone Num, MIN, or IMSI. The lower field is the value.

Phone Num Settings: 0 through 9999999999

MIN2 MIN1 Settings: 0 through FFFFFFFF

IMSI Dec Settings: 0 through 999999999999999

IMSI Hex Settings: 0 through FFFFFFFFFFFFFFFF

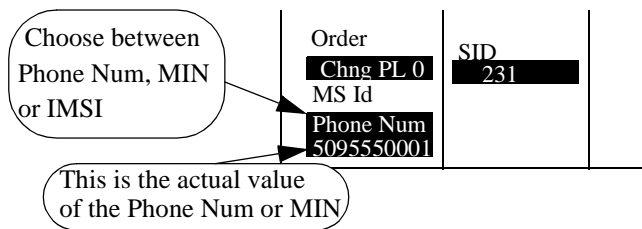

Order

Settings: Chng PL 0 through 10, Send MWI, and Send SMS for DTC; Chng PL 0 through 7, MAINTEN, and ALERT for AVC

Units: None.

These are the available orders that can be sent to the mobile when in the connect state. The field name is changed to **Cntl Order** or **CC Order** (when authentication is turned on), and the choices are changed, when the mobile is not in the connect state.

Note that the available choices in the **Order** field are valid choices for the current channel only.

See also, "Which Control Order Command Should I Use?" in the *HP 8920B Option 801 Condensed Programming Reference*.

Page

Settings: This is an immediate action field. Selecting it starts the action.

Units: None.

Page is both an annunciator and a command. This command instructs the Test Set to page the mobile identified in the **MS ID** field. The annunciator indicates the Test Set is sending the Page message.

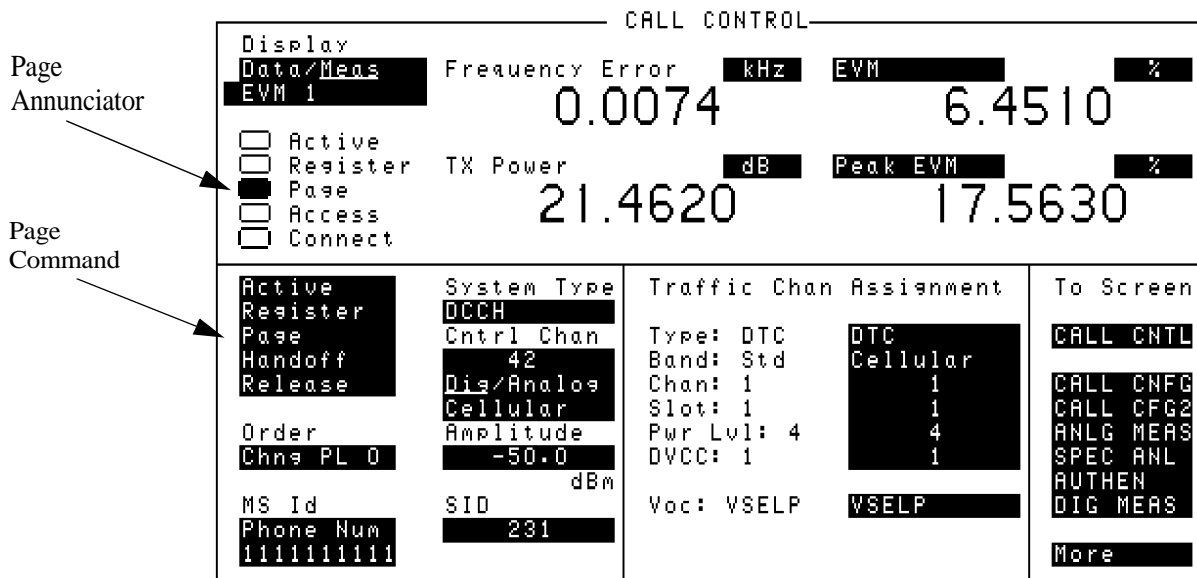

Figure 67

The Page Command and Annunciator Display (CALL CONTROL Screen)

Pwr Lvl Settings: 0 through 10 for DTC, 0 through 7 for AVC. Note that Power Level 0 is the maximum power.

Units: None, Integer values.

This is the power level that the mobile is to use.

CHANGING POWER LEVELS

This parameter will change the power of the mobile when a voice or traffic channel assignment is made. This includes whenever a handoff occurs. To send an order that will change the mobile's power, use the **Order** field in the lower left-hand corner of the screen.

Register

Settings: This is an immediate action field. Selecting it starts the action.

Units: None.

Register is both an annunciator and a command. This command instructs the mobile to register with the Test Set (emulated base station). The annunciator indicates the Test Set is sending the Register message.

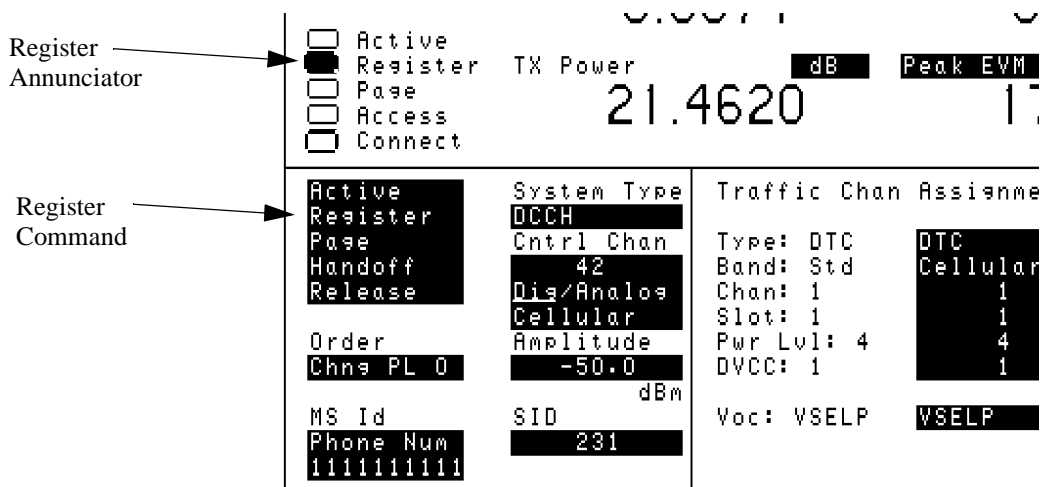

Figure 68 The Register Command and Annunciator Display (CALL CONTROL Screen)

Release

Settings: This is an immediate action field. Selecting it starts the action.

Units: None.

Release is a command. This command instructs the Test Set to release the call in progress.

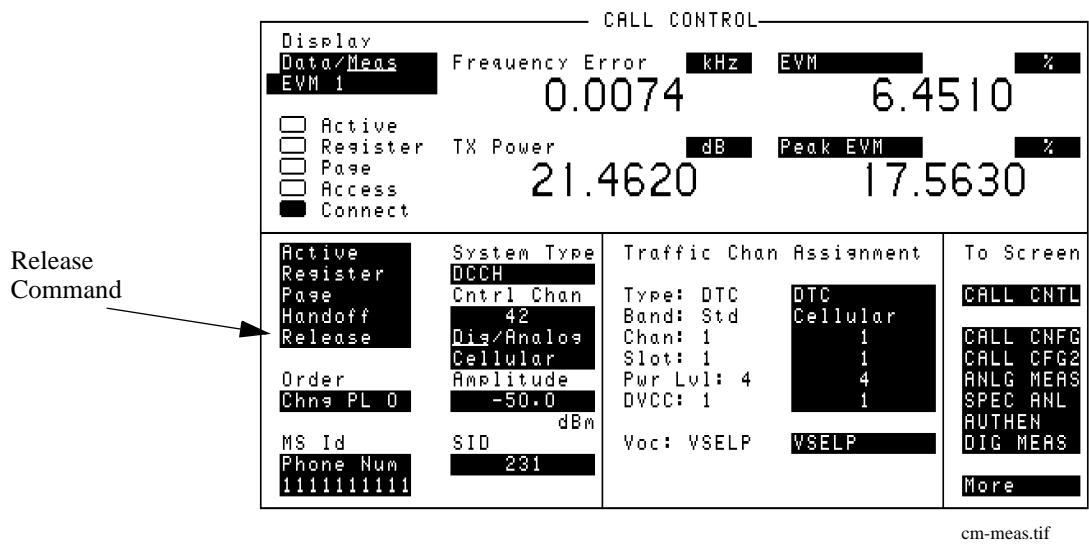

Figure 69

The Release Command Display (CALL CONTROL Screen)

SAT

Settings: 5970, 6000, 6030

Units: Hz.

This is the Supervisory Audio Tone. Used with AVC only.

SID

Settings: 1 through 32767

Units: None, Decimal or hexadecimal values.

This is the System Identification of the system which the Test Set is emulating.

Slot	<p>Settings: 1 through 6</p> <p>Units: None, Integer values.</p> <p>Slot is for the DTC only. The timeslot which the mobile is directed to use.</p> <p>During full-rate transmission, slots are paired in the following manner: 1&4, 2&5, 3&6.</p>
System Type	<p>Settings: select DCCH for testing TIA/EIA-136 mobiles, DAMPS for TIA/EIA-627 mobiles.</p> <p>Units: None.</p> <p>System Type lists the different systems which can be controlled with the appropriate Cellular Adapter. To test TIA/EIA-136 mobiles using the digital control channel, select DCCH.</p>
Traffic Channel Assignment	<p>Settings: this is a group of fields (Type, Band, Chan, Slot, Pwr Lvl, DVCC)</p> <p>Units: None.</p> <p>Traffic Channel Assignment is a group of fields associated with a Digital Traffic Channel. For the fields associated with the AVC, see Voice Channel Assignment.</p>
Type	<p>Settings: DTC or AVC</p> <p>Units: None.</p> <p>The channel type for the voice/traffic channel. DTC is the Digital Traffic Channel, AVC is the Analog Voice Channel.</p>

VC Order

Settings: Chng PL 0 through 10, Send MWI, SSD Upd, Uniq Ch, and Send SMS.

Units: None

These are the available orders that can be sent to the mobile when in the connect state when authentication is turned on. If authentication is not turned on, and the mobile is in the connect state, this field name is changed to **Order**.

The field name is changed to **Cnt1 Order** or **CC Order** (when authentication is turned on) when the mobile is *not* in the connect state.

See also, “Which Control Order Command Should I Use?” in the *HP 8920B Option 801 Condensed Programming Reference*.

Voc

Settings: VSELP or ACELP

Units: None

Select the type of vocoder used by the mobile. This field is displayed only when the system type is DCCH.

Voice Channel Assignment

Settings: this is a group of fields (Type, Chan, Pwr Lvl, SAT)

Units: None.

A group of fields associated with an Analog Voice Channel. See also Traffic Channel Assignment.

Parameters of the DCCH CALL CONFIGURE Screen

The DCCH CALL CONFIGURE screen allows you to modify features for TIA/EIA-136.

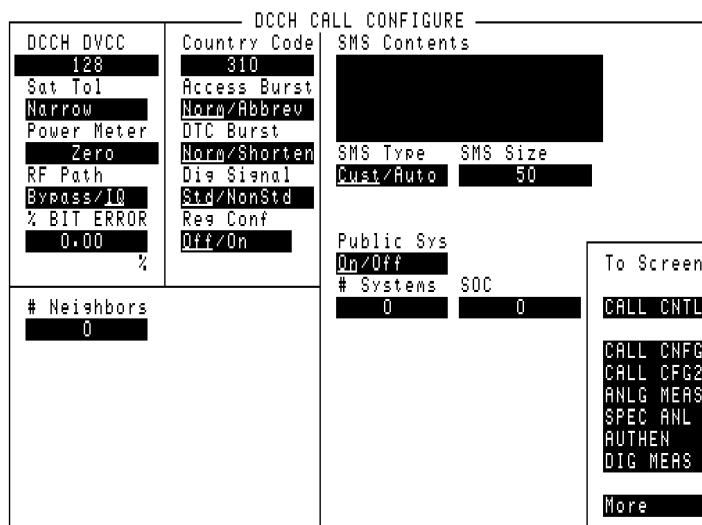

dcch_cc.tif

Figure 70 **The DCCH CALL CONFIGURE Screen**

Neighbors

Settings: 0 through 6

Units: None.

Neighbors selects the number of neighbor channels to be evaluated with the MAHO command. If the choice is non-zero, then a set of fields appears below this field. You can then select the channels to be evaluated. See [“BAND \(Neighbor List\)”](#), and [“Channel \(Neighbor List\)”](#) on page 221.

# Systems	Settings: 1 through 8 Units: None Specifies the number of residential or public systems and causes the PSID/RSID field to be displayed.
% BIT ERROR	Settings: 0.00 through 20.00 Units: %. This sets the percentage (%) of bit errors to be inserted when measuring BER, WER, or MAHO BER. To insert errors on a DTC, the mobile <i>must</i> be up on a call before the % bit error can be entered. To insert errors in test mode, set up the channel first, then enter the % bit error.
Access Burst	Choices: Norm or Abbrev Units: None. Access Burst selects between a normal burst or abbreviated burst.
BAND (Neighbor List)	Settings: Cellular or US PCS Units: None. This is the frequency band of the channels in the neighbor list. This field is displayed only when the # Neighbors field is set greater than 0.
Channel (Neighbor List)	Settings: 1 through 799 Units: None. This is the channel number of the channels in the neighbor list. This field is displayed only when the # Neighbors field is set greater than 0.
Country Code	Settings: 0 through 999 Units: None. This is the country code as per CCITT E.212

DCCH DVCC	Settings: 0 through 255 Units: None. This is the DVCC which applies to the DCCH only. For the DVCC of the DTC, see “Parameters of the CALL CONTROL Screen” on page 208.
Dig Signal	Settings: Std or NonStd Units: None. Dig Signal specifies if the received signal should conform to standard DCCH or DAMPS protocol. NonStd causes the Cellular Adapter’s DSP to ignore protocol discrepancies and only report an error condition if the signal level is too high.
DTC Burst	Settings: Norm or Shorten Units: None. DTC Burst selects between a normal burst or shortened burst. The shortened burst is usually transmitted as part of time alignment to help avoid collisions between the mobile’s burst and the burst in an adjoining time slot.
Power Meter	Settings: This is an action field. Selecting this field automatically zeros the power meter within the Test Set. Units: None.
PSID/RSID	Settings: PSID or RSID, and 1 through 65,535 Units: None Lists the private or residential systems and the associated system number for each system. This field is only displayed if the value of the # systems field is ≥ 1 .

Public Sys

Settings: On or Off

Units: None

This enables or disables the Non-Public System operation. It is used in conjunction with the # **Systems**, **MCC**, **PSID/RSID**, and **SOC** fields.

RF Path

Settings: Bypass or IQ

Units: None

This switches the RF Generator's IQ modulator in or out of the generator's path. This function is normally switched automatically, depending on the System Type and/or Cntrl Chan selected. The Bypass setting is used for creating analog signals, such as standard AMPS voice channels. This field overrides the automatic setting if necessary (such as when you want to calibrate TX Power with an analog signal while displaying the DIGITAL MEASUREMENTS screen).

Reg Conf

Settings: On or Off

Units: None

The Registration Confirmation field is used when sending a registration command to the mobile. When set to **On**, this field causes the Test System to automatically send a confirmation message to the mobile after the Test System correctly receives the registration information from the mobile.

Sat Tol

Settings: Narrow or Wide

Units: None

This sets the allowed frequency error for the mobile's supervisory audio tone (SAT) when connecting to an AVC. The **wide** setting can be beneficial when processing a call where a large amount of noise is present with the SAT tone.

- **Narrow** - requires the sat tone to be within ± 10 Hz of the frequency specified in the CALL CONTROL screen **SAT** field when connected on an AVC.
- **Wide** - accepts a sat tone in the range of 0 Hz to 7 kHz.

SMS Contents

Settings: Up to 96 characters.

Units: None

This allows you to enter a custom Short Message Services (SMS) message to transmit to the mobile. The message is sent when **send SMS** is selected from the CALL CONTROL screen's **Order** or **Cnt1 Order** field. The number of characters that are transmitted is determined by the **SMS size** field.

SMS Msg

Settings: 243 factory-defined characters.

Units: None

A 243-character message is automatically placed in this field when the SMS Type is set to Auto. You can edit the first 96 characters if desired, but the remaining characters cannot be changed or viewed.

The message is sent when **send SMS** is selected from the CALL CONTROL screen's **Order** or **Cnt1 Order** field. The number of characters that are transmitted is determined by the **SMS size** field.

SMS Size

Settings: 1 through 243.

Units: characters (implied)

This setting defines the number of characters in the **SMS Contents** field that are used when an SMS message is sent. The factory-defined character string "Auto" uses the full 243 characters allowed.

SMS Type

Settings: Custom or Auto.

Units: None

This setting selects the SMS message to send:

Cust uses the characters you enter in the **SMS Contents** field.

Auto automatically enters a factory-defined message into the **SMS Contents** field.

The number of characters sent in the message is controlled by the **SMS size** field.

SOC

Settings: 0 through 4096

Units: None

Enter the System Operating Code when using Non-public System functions.

Parameters of the DCCH CALL CONFIGURE II Screen

The DCCH CALL CONFIGURE II screen is used to define information sent to the mobile for testing message waiting (MWI) and caller ID functions.

The screenshot shows the 'DCCH CALL CONFIGURE II' screen with the following fields and values:

Num Voice	0	Temperature	Compensate
Num SMS	0	MS Capab	Cellular
Num Fax	0		
Calling Num			
Calling Name			
Name Size	0		
Pres Type			
Pres OK			
Screen Ind			
Not Scrn			
		To Screen	CALL CNTL
			CALL CNFG
			CALL CFG2
			ANLG MEAS
			SPEC ANL
			AUTHEN
			DIG MEAS
			More

Calconf2.tif

Figure 71 The DCCH CALL CONFIGURE II Screen

Calling Name

Settings: 25 characters

Units: None

This is the name of the station that is calling the mobile.

Calling Num

Settings: Integer. Ten characters maximum.

Units: None.

This is the number of the station that is calling the mobile.

MS Capab	Settings: Cellular, US PCS, or Band 10 Units: None Specify whether the mobile uses standard cellular protocol or if it is PCS-capable. If you are testing a PCS-capable mobile in the cellular band, you should still specify US PCS. For downbanding, specify Band 10 (see “Downbanding” on page 81.)
Name Size	Settings: 0 through 25 Units: None This is the number of characters in the Calling Name field that are sent.
Num Fax	Settings: 0 through 99 Units: None Specifies the number of fax messages that are waiting for the mobile to respond to. This is used in the message waiting indicator (MWI) command.
Num SMS	Settings: 0 through 99 Units: None Specifies the number of short message services (SMS) messages that are waiting for the mobile to respond to. This is used in the message waiting indicator (MWI) command.
Num Voice	Settings: 0 through 99 Units: None Specifies the number of voice messages that are waiting for the mobile to respond to. This is used in the message waiting indicator (MWI) command.

Pres Type Settings: Pres OK (presentation allowed), Pres Res (presentation restricted), and Not Avail (number not available)

Units: None

This determines the information that is sent when calling a mobile:

- **Pres OK** - both the Calling Name and Calling Number are sent.
- **Pres Res** - only the Calling Number is sent.
- **Not Avail** - neither the Calling Name or Calling Number are sent.

Screen Ind Settings: Not Scrn (not screened), Ver&Pass (verified and passed), Ver&Fail (verified and failed), and Nwrk Prov (network provided)

Units: None

Temperature Setting: This is an immediate action field that is only used if a PCS Interface is attached. Selecting this field causes the PCS Interface to perform a temperature compensation routine to improve measurement accuracy through the interface.

Units: None

Parameters of the DIGITAL MEASUREMENT Screen

The DIGITAL MEASUREMENT screen enables measurements in the test mode of the mobile.

The DIGITAL MEASUREMENT Screen

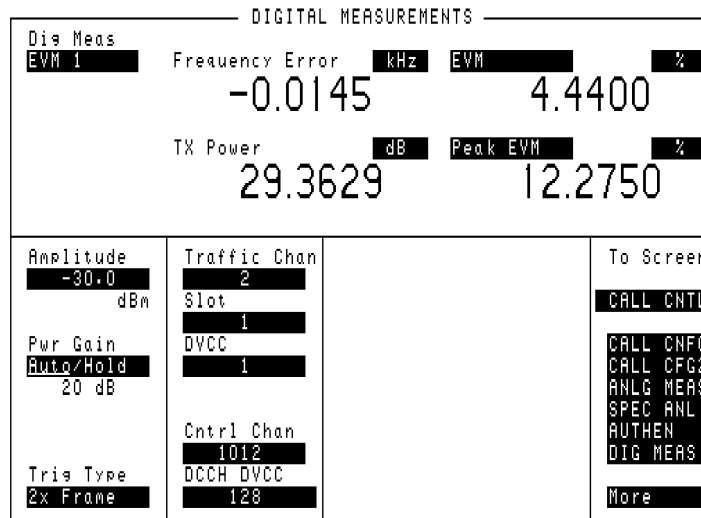

dig_meas.tif

Figure 72

The DIGITAL MEASUREMENT Screen

Amplitude	Settings: -137.0 to +18.0 Units: dBm. This is the amplitude of the RF signal that the Test Set will transmit. Note: you may have to adjust the RF Gen Amplitude, Output Port, or Atten Hold when using values above 0 dBm. Refer to the HP 8920 Series RF Test Set User Guide for more information. Note that the available setting is greater than both the specified maximum output power of the Test System and the system specification as well. This is done to allow you to use the maximum output power of each individual Test Set.
Dig Meas	Settings: EVM1, EVM10, Adj Ch Pwr, Avg Pwr, BER, DTC WER, DCCH WER Units: None. This field shows the set of measurements that are being displayed.
DVCC	Settings: 1 through 255 Units: None, Integer values. This is the Digital Verification Color Code. This is for the DTC only. For the DVCC of the DCCH, see “Parameters of the DCCH CALL CONFIGURE Screen” on page 220 .
Pwr Gain	Settings: Auto, Hold Units: dBm, Integer values. Pwr Gain controls the RF attenuator and the DSP gain. Used with Average Power, it is frequently best to keep this in Auto mode.

Slot

Settings: 1 through 6

Units: None, Integer values.

Slot is for the DTC only. The timeslot which the mobile is directed to use.

During half-rate transmission, slots are paired in the following manner: 1&4, 2&5, 3&6.

Traffic Chan

Settings: 1 through 799, 990 through 1023

Units: None, Integer values.

This is the channel number of the traffic channel.

Note that if you change the **Traffic Channel number** field in the DIGITAL MEASUREMENT screen, the **RF Gen Frequency** field in the Duplex screen changes corresponding to the new channel number. However, if you change the **RF Gen Frequency** field in the Duplex screen, the Traffic Channel number does not change.

Trig Type

Settings: Amptd Hi, Amptd Mid, Amptd Low, Immediate, ANL TG IN, Frame Clk, 2x Frame

Units: None

This field specifies the trigger conditions for the digital analyzer.

Selecting the appropriate trigger is necessary when making BER measurements and aligning the digital analyzer to timeslots for power, adjacent channel power, or EVM measurements.

Selecting **Immediate** causes the analyzer to be triggered immediately.

Selecting **ANL TG IN** causes the analyzer to be triggered by the signal at the HP 83206A's ANALYZER TRIGGER IN connector. However, this connector is not active on the HP 82603A.

Selecting **2x Frame** causes the analyzer to be triggered by the 50 Hz, 2 × frame clock provided by the Test Set's digital generator.

Selecting **Frame Clk** causes the analyzer to be triggered by the 25 Hz frame clock provided by the Test Set's digital generator.

Amplitude triggering uses low-to-high amplitude transitions in pulsed carriers as the trigger source. Trigger thresholds are at -6 dB (**Amptd Hi**), -12 dB (**Amptd Mid**), and -18 dB (**Amptd Low**) from the maximum AdcMaxAbs level. The **Input** field must be set to either **Int IF** or **Ext IF IN**.

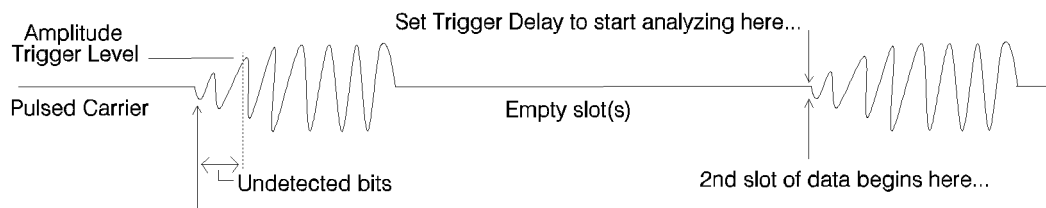

Parameters of the ANALOG MEASUREMENT Screen

This screen is used to make RF and audio measurements on the mobile station connected to the simulated base station while on an active voice channel.

The host firmware does *not* monitor the mobile station's transmitted carrier power while the ANALOG MEASUREMENT screen is displayed. If the power falls below 0.0005 Watts no error message is displayed nor will the simulated base station terminate the call while on the ANALOG MEASUREMENT screen.

The ANALOG MEASUREMENT Screen

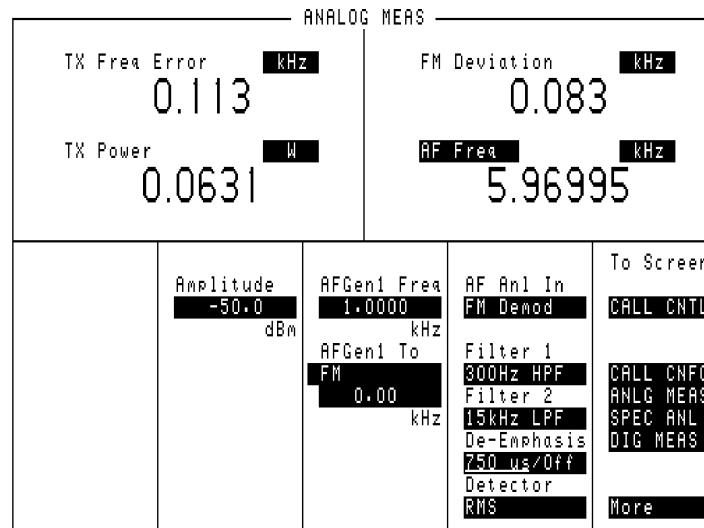

scrn28.tif

Figure 73 The ANALOG MEASUREMENT Screen (when DAMPS system type is selected)

AF Anl In

Settings: FM Demod, AM Demod, SSB Demod, Audio In, Radio In, Ext Mod, Mic Mod, FM Mod, AM Mod, Audio Out

Units: None.

This field selects the input for the Audio Frequency analyzer.

- AF Freq** Settings: SINAD, Distn, SNR, AF Freq, DC Level, Current
Units: None.
This field is a one-of-many field used to select the type of measurement to be made by the Audio Frequency Analyzer on the audio signal being measured.
- AFGen1 Freq** Settings: 0 through 30 kHz
Units: kHz, Hz, real values
This field sets the output frequency of Audio Frequency Generator #1.
- AFGen1 To** This field has two subfields:
- the upper subfield sets the destination port for Audio Frequency Generator #1
 - **FM** = RF Generator FM modulator
 - **AM** = RF Generator AM modulator
 - **Audio Out** = AUDIO OUT connector on front panel of Test Set
 - the lower subfield sets the:
 - FM modulation deviation if upper subfield set to **FM** (Units: Hz, kHz)
 - AM modulation depth if upper subfield set to **AM** (Units: %)
 - amplitude of audio signal at the AUDIO OUT connector if upper subfield set to **Audio Out** (Units: volts rms)
- For testing mobile stations the upper field is normally set to **FM** and the lower field set to the desired FM deviation in kHz.
- Amplitude** Settings: -137.0 through +18.01
Units: dBm.
This field sets the output power of the simulated base station's transmitter (the output power of the Test Set's RF Generator).
Note that the available setting is greater than both the specified maximum output power of the Test System and the system specification as well. This is done to allow you to use the maximum output power of each individual Test Set.
- De-Emphasis** Settings: 750 us, Off
De-Emphasis is used to select or bypass the 750 μ s de-emphasis filter network used to condition the audio signal before being analyzed by the Audio Frequency Analyzer.
Units: None.

Detector	<p>Settings: RMS, RMS*SQRT2, PK+, PK-, Pk±/2, Pk±Max, Pk+ Hold, Pk±/2 Hold, Pk±Mx Hold</p> <p>Units: None.</p> <p>This field is used to select the type of detector used to measure the amplitude of the audio signal being measured.</p>
Filter 1	<p>Settings: <20Hz HPF, 50Hz HPF, 300Hz HPF, C MESSAGE</p> <p>Units: None.</p> <p>This field selects one of several standard or optional audio frequency filters which can be used to condition the audio signal before being analyzed by the Audio Frequency Analyzer.</p>
Filter 2	<p>Settings: 300Hz LPF, 3kHz LPF, 15kHz LPF, >99kHz LPF, 6kHz BPF</p> <p>Units: None.</p> <p>This field selects one of several standard or optional audio frequency filters which can be used to condition the audio signal before being analyzed by the Audio Frequency Analyzer.</p>
FM Deviation	<p>This is a measurement</p> <p>This field displays the measured FM deviation of the carrier being transmitted by the mobile station. Four dashes (----) indicate that no carrier is present to measure.</p>
TX Freq Error	<p>This is a measurement</p> <p>This field displays the frequency error (error = assigned carrier frequency - measured carrier frequency) of the carrier being transmitted by the mobile station. Four dashes (----) indicates that there is no carrier frequency present to measure.</p>
TX Power	<p>This is a measurement</p> <p>This field displays the measured RF power of the carrier being transmitted by the mobile station. Four dashes (----) indicates that there is no carrier present to measure.</p>

Parameters of the DTC AUTHENTICATION Screen

This screen provides authentication features that are used to test the mobile's call security functions to prevent call fraud on a DTC. Authentication enables the base station to confirm the mobile's identity.

The screen shown in [Figure 74](#) is displayed when the **System Type** field on the CALL CONTROL screen is set to **DCCH**, the **Cntrl Chan** field is set to **Dig**, and the mobile is connected to a DTC.

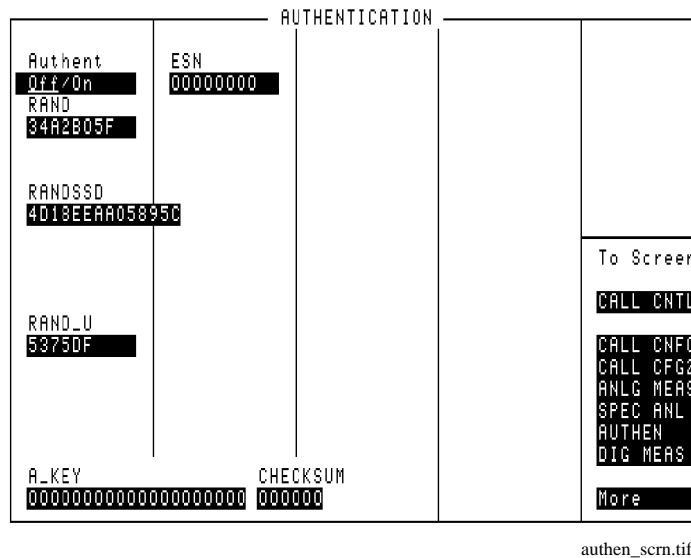

Figure 74 **The Authentication Screen (when assigned to a DTC)**

A_KEY

Settings: 20-digits

Units: None

The A_key is a 26-digit number stored in the mobile station's permanent security and identification memory and is not accessible to the user. The number you enter must match that in the mobile. This field lets you enter the first 20 digits of this value; the other 6 digits are computed using a special algorithm and are automatically entered in the **CHECKSUM** field.

The user must obtain a valid **A_Key** from the mobile station's manufacturer or from the HLR/AC to test Authentication procedures, otherwise the authentication process will fail. The Test Set does not write data back to the A_key field during manual operation.

Authent

Settings: Off or On

Units: None

This turns authentication features on or off for call processing operations.

CHECKSUM

Settings: 6-digit hexadecimal value

Units: None

This field contains the last 6 digits of the A_key. The first 20 digits are entered in the A_KEY field.

ESN

This field is used to enter the electronic serial number (ESN) of the mobile station. There are two methods which can be used to enter the **ESN**. The serial number can be entered as an 8-digit hexadecimal value directly into this field or it can be captured by the Test Set through a registration order.

To enter the electronic serial number directly, select the ESN field and enter the information in hexadecimal format.

RAND

RAND is a 32 bit value that is entered as an 8-digit hexadecimal number. The mobile station stores and uses the most recent version of RAND in the authentication process.

RANDSSD

RANDSSD is a 56-bit random number (14 hexadecimal digits) created by the home system for the mobile, and must be entered prior to issuing a Shared Secret Data (SSD) Update. This value is used with the mobile station's A-key and ESN to create its Shared Secret Data (SSD).

RAND_U

RAND_U is the 24-bit random number issued by the base station in the Unique Challenge Order. RAND_U is entered as a 6-digit hexadecimal value.

Parameters of the AVC AUTHENTICATION Screen

The following fields are displayed on the AUTHENTICATION screen when the **System Type** field on the CALL CONTROL screen is set to **DCCH** and the **Cntrl Chan** field is set to **Analog**, or when the mobile is connected on an Analog Voice Channel (AVC).

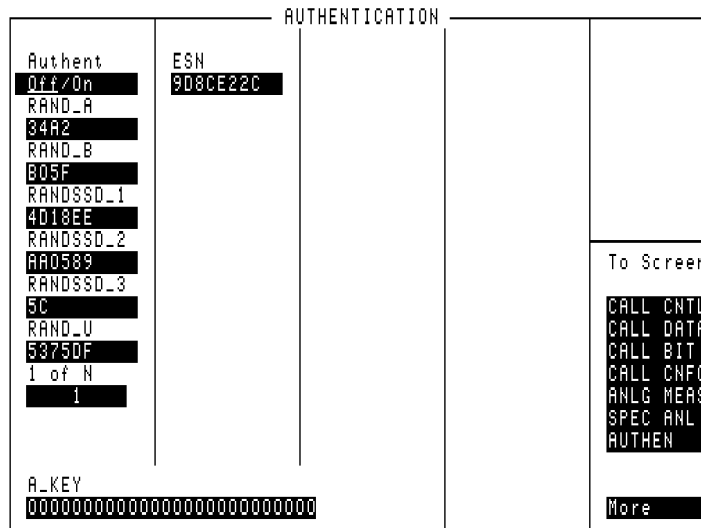

Authen.pcx

Figure 75

The AUTHENTICATION Screen (when assigned to an AVC)

These parameters are used by the Cave algorithm during Call Processing functions such as registration, page, and originate to verify a valid call.

A_Key

Settings: 26-digit

Units: None

The A_key is a 26-digit decimal number stored in the mobile station's permanent security and identification memory and is not accessible to the user. The user must obtain a valid **A_Key** from the mobile station's manufacturer or from the HLR/AC to test Authentication procedures, otherwise the authentication process will fail. The Test Set reads the first 20-digits and using them during the authentication process. The Test Set does not write data back to the A_key field during manual operation.

NOTE: A_key generation is not available through the manual user interface. A_key generation is only supported through the remote user interface.

Authent

Settings: Off or On

Units: None

This field is used to activate the authentication process within the Test Set. With this field set to **On**, the Test Set issues system parameter overhead messages including **SPC WORD1**, **SPC WORD2**, **ACCESS**, **RandChalA**, and **RandChalB** to the mobile station.

ESN

Settings: 8-digit hexadecimal

Units: None

This field is used to enter the electronic serial number (ESN) of the mobile station. There are two methods which can be used to enter the **ESN**. The serial number can be entered as an 8-digit hexadecimal value directly into this field or it can be captured by the Test Set through a registration order.

To enter the electronic serial number directly, select the ESN field and enter the information in hexadecimal format.

RAND_A

Settings: 4-digit hexadecimal

Units: None

RAND_A is the 16 most significant bits of **RAND** and is entered as a 4-digit hexadecimal value. The mobile station stores and uses the most recent version of RAND in the authentication process. RAND_A is user definable.

RAND_B

Settings: 4-digit hexadecimal

Units: None

RAND_B is the 16 least significant bits of **RAND** and is entered as a 4-digit hexadecimal value. The mobile station stores and uses the most recent version of RAND in the authentication process. RAND_B is user definable.

RANDSSD_1

Settings: 6-digit hexadecimal

Units: None

RANDSSD_1 is the 24 most significant bits of the random number issued by the base station in the SSD Update Order. RANDSSD_1 is user definable.

RANDSSD_2

Settings: 6-digit hexadecimal

Units: None

RANDSSD_2 is the 24 subsequent bits (following RANDSSD_1) of the random number issued by the base station in the SSD Update Order. RANDSSD_2 is user definable.

RANDSSD_3

Settings: 2-digit hexadecimal

Units: None

RANDSSD_3 is the 8 least significant bits of the random number issued by the base station in the SSD Update Order.

RAND_U

Settings: 6-decimal hexadecimal

Units: None

RAND_U is the 24-bit random number issued by the base station in the Unique Challenge Order. RAND__U is user definable.

1 of N

Settings: 1 through 10 decimal

Units: None

The 1 of N field instructs the Test Set how many times to send a system parameter overhead message. The message contains RAND values, RAND_A and RAND_B. The RAND values are difficult for phones which do not support authentication to parse. This field allows for testing of these phones along with the testing of phones which support authentication by altering the number of times the system parameter message is sent to the mobile station.

Connector Descriptions

This chapter lists the connectors on the front and back panels, and provides a brief description of each.

Connector overview

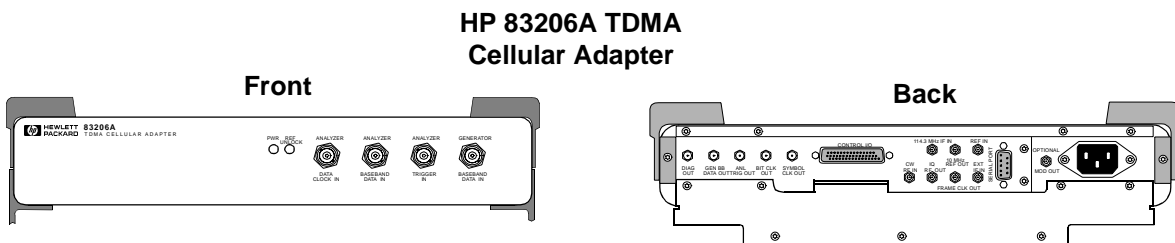

Figure 76 HP 83206A Cellular Adapter Connectors Front and Back Views

Front Panel Connectors

Analyzer Baseband Data In Direct Input to the Digital Analyzer for analyzing data streams. This input is available through HP-IB control of the TDMA Encoder screen. (Not in use at this time)

Operating Considerations

The rising edge of the Analyzer Data Clock In signal triggers the analyzer to read this data.

The data must be present on the input for greater than or equal to 100 nsec before the rising edge of the clock. The data must be stable on this input for ≥ 1.3 microsec after being triggered by the Data Clock to correctly read the data.

Input level = TTL

Input impedance = 100 k Ω

Data rates:

- 48.6 kbit/sec

Analyzer Data Clock In The rising edge of the signal applied to this front panel port causes the data on the Analyzer Baseband Data In connector to be sampled by the Digital Analyzer. (Not in use at this time)

Operating Considerations

Input level = TTL

Input impedance = 100 k Ω

Expected Clock Frequency:

- 48.6 kbit/sec

Analyzer Trigger In This connector allows external signals to trigger the Digital Analyzer to begin sampling the selected input. (Not in use at this time)

Operating Considerations

Used for frame synchronization of the analyzer.

Input impedance = 100 k Ω

Input level = TTL (rising edge)

Generator Baseband Data In This connector allows you to send external data to the Pre-modulation filter/IQ modulator. (Not in use at this time)

Operating considerations

When using an external reference, the same reference used to generate the Baseband data must also be connected to the Cellular Adapter's Ref In connector to correctly clock the data.

Modulation data consists of two-bit symbols (00, 01, 10, 11) that are sent to the Pre-modulation filter. The first bit of a symbol is clocked in on the rising edge of the symbol clock. Care must be taken to properly align the input data with the Symbol Clock to correctly modulate the Digital Generator.

This signal is not affected by the **Data Delay** field setting. The nominal delay from the first data bit in a two-bit symbol to its peak RF response (decision point) after pi/4 DQPSK modulation is 12 bits (6 symbols).

Input level = TTL

Data rate = 48.6 kbits/sec

Input impedance = 100 k Ω

Rear Panel Connectors

Anl Trig Out This connector outputs the signal used to synchronize external equipment to the Digital Analyzer. A rising edge indicates the Analyzer was triggered. (Not in use at this time)

Operating Considerations

All values are rounded to the nearest full bit.

Bit Clk Out This signal outputs a square wave from the Digital Generator's Bit Clock. This allows you to synchronize external equipment to the Digital Generator.

Operating Considerations

When using internally generated data, the Gen BB Data Out signal is stable before the rising edge of the Bit Clk Out, allowing the Bit Clock to be used to strobe the data into your external equipment.

Output frequency = 48.6 kHz

Output level = CMOS

Output impedance = 50 Ohms

Control I/O This connector provides data communication between the Test Set and the Cellular Adapter. The Cellular Adapter cannot be turned on without this cable attached to an operating Test Set.

CW RF In This is the RF carrier input to the Cellular Adapter. It is normally connected to the Test Set's CW RF Out connector.

Operating Considerations

Nominal input level = 0 dBm, +/- 4 dB

Maximum input level = + 12dBm

Input impedance = 50 Ohms

Frequency range:

- 500 to 1000 MHz without IQ modulation
- 810 to 956 MHz with IQ modulation

Diag Out This port provides various signals used to service the Cellular Adapter.

When servicing the Cellular Adapter, this port is connected directly to the Test Set's AUDIO IN (HI) connector. Diagnostic routines are then run using the Test Set's internal IBASIC computer to locate the faulty module.

Ext IF In This port is generally connected to the HP 8920B Option 006 DET OUT port for making the average power measurement.

This connector allows an external IF signal to be used in place of the 114.3 MHz IF that comes from the Test Set. This allows you to provide your own external downconversion of the modulated carrier, bypassing the Test Set receiver down conversion to 114.3 MHz and Cellular Adapter down conversion to 700 kHz.

Operating Considerations

Input Frequency = 700 kHz, +/- 1 kHz

Input level range = 30 to 400 mV peak

Input impedance = about 1 k Ohm

Set the Sample Clk to 2.5 MHz for a 700 kHz IF and 1 MHz for a 220 kHz IF.

Frame Clk Out	<p>This connector provides a square wave from the Digital Generator's Frame Clock. This allows you to synchronize external equipment to the Digital Generator.</p> <p>Operating Considerations</p> <p>Nominal output frequency = 25 Hz</p> <p>Output level = CMOS</p> <p>Output impedance = 50 Ohms</p>
Gen BB Data Out	<p>This connector monitors the digital signal applied to the Pre-modulation Filter/IQ Modulator. This signal comes from either of two sources:</p> <p>The internal Digital Generator section</p> <p>The front panel Generator Baseband Data In connector (not available yet)</p> <p>Operating considerations</p> <p>The nominal delay from the first data bit in a two bit symbol to its peak RF response after pi/4 DQPSK modulation is 12 bits (6 symbols).</p> <p>Output level = CMOS</p> <p>Output impedance = 50 Ohms</p> <p>Nominal Data Rate = 48.3 kbits/sec</p>
Ref In	<p>This connector provides a timing reference for the Digital Generator and Digital Analyzer sections. One of these frequencies must be used:</p> <p>25 Hz, 50 Hz, 24.3 kHz, 48.6 kHz, 1 MHz, 2 MHz, 5 MHz, 10 MHz</p> <p>Operating Considerations</p> <p>The Ref Unlock indicator is lit if the reference signal's frequency does not match this field setting.</p>

NOTE:

Using a Frame or 2X Frame Reference: it takes about 30 seconds to lock to a 25 or 50 Hz reference after connecting the reference signal and selecting the correct setting in the Reference field. The 200 and 400 Hz selections are a little faster. If the reference signal is disconnected and then reconnected, you must re-select the reference frequency in the Reference field to start the phase-locking process over again. If you do not re-select the reference frequency, it can take hours to re-establish phase lock with these very low frequency references.

Serial Port

Not used.

Symbol Clk Out

This connector provides an output for the Symbol Clock of the Digital Generator. This allows you to synchronize external equipment to the Digital Generator.

Operating Considerations

Data Delay is not programmable yet. When using internally generated data, and the Data Delay value is an even number, the first bit of a symbol is present on the rising edge of the Symbol Clock. If the delay is an odd number, the second bit of the symbol is present on the rising edge of the Symbol Clock.

Nominal output frequency = 24.3 kHz

Nominal output = CMOS

Output impedance = 50 Ohms

114.3 MHz IF In

This connector is where the Cellular Adapter receives the 114.3 MHz IF from the Test Set's receiver section. It is usually connected to the Test Set's 114.3 MHz IF OUT port.

Operating Considerations

Input impedance = 50 Ohms

Input level range = -53 to -30 dBm

Input Bandwidth: The incoming signal goes through a 114.3 MHz bandpass filter with about 400 kHz 3 dB bandwidth before down-conversion to 700 kHz. A 20 MHz LPF and a 3 MHz LPF provide additional filtering before being analyzed.

10 MHz REF OUT This rear-panel port outputs a 10 MHz reference. This signal is phase locked to the signal applied to the REF IN port. All clocks (Bit, Symbol, and Frame) are derived from or phase locked to this signal.

If the REF UNLOCK indicator is lit, the output frequency may not be accurate.

Operating Considerations

Nominal output level: $>+5$ dBm

Output impedance = 50Ω

Frequency stability = the same as the signal applied to the REF IN connector (typically needs to be within ± 5 ppm of the selected **Reference** frequency).

IQ RF OUT

This rear-panel port outputs the carrier applied to the rear-panel CW RF IN connector.

This port is normally connected to the Test Set's rear-panel IQ RF IN connector.

Operating Considerations

Even when the Digital Generator is not actively sending a message, the IQ Modulator still receives symbol data.

Output impedance = 50 Ω

Nominal output level:

- -9.5 dBm (± 1.5 dB) when IQ modulated.
- 0 dBm un-modulated (CW).

Frequency range:

- 500 to 1000 MHz without IQ modulation (may have AM or FM from the Test Set).
- 810 to 956 MHz with IQ modulation.

Troubleshooting

This section discusses the probable causes of some problems that may occur while using the HP 83206A in your Test System. Sections are divided into groups dealing with specify hardware configurations and operating modes.

Call for HP Support

If, after using the information in this section, you still cannot solve your problem, call the HP Help line at 1-800-922-8920 (USA and Canada only) for product or application assistance.

General Operating Reminders

If a Non-recoverable Firmware Error is Encountered

When a non-recoverable firmware error occurs, the Test Set is “locked up”, and displays a message indicating that you must turn the Test Set off and back on before you can use the Test Set again. If you encounter this type of message, you should record the information listed below before turning the Test Set off, and then call your HP Field Engineer. You may also call the HP Support line at 1-800-922-8920.

When calling in to report a non-recoverable firmware error, have the following information ready:

- Your name and phone number.
- Your company’s name and address.
- The Test Set model number.
- The Test Set’s firmware revision (displayed at the top of the screen during power-on and also on the CONFIGURE screen).
- The Call Processing system type you were using (DCCH, AMPS...etc).
- The make and model of mobile you are using.
- How often this error occurs when repeating the operation that originally caused the error.
- Complete message displayed when the error occurs.
- How to duplicate the error. This is especially important when getting help. If your HP contact person has the needed instrument(s), that person will try to duplicate the operation as soon as possible to try to help you isolate the problem.

The REF UNLOCK Indicator Must be Off

The REF UNLOCK indicator on the front panel of the Cellular Adapter must be off during operation (and the PWR indicator must be lit). If the REF UNLOCK indicator is lit, the Cellular Adapter is not receiving the 10 MHz reference from the Test Set. Connections for the Cellular Adapter and PCS Interface are shown in [Chapter 11, “Installing the Cellular Adapter,” on page 285](#).

Displaying DCCH Screens

To access the various DCCH screens shown in this manual, you must access the CALL CONTROL screen and set the **System Type** field to DCCH. See [“Going to the TIA/EIA-136 CALL CONTROL Screen” on page 37](#).

Making Handoffs

To make a handoff from a DTC or AVC to another channel, you must first set the **Traffic Channel Assignment** fields to indicate the channel you want the mobile to go to. You must then select the **Handoff** field to initiate the handoff.

Making Accurate Power Measurements

The Average Power and TX Power (Avg) measurements should be periodically calibrated during operation by selecting the **Power Meter [Zero]** field on the DCCH CALL CONFIGURE screen.

The relative TX Power [dB] measurement needs to be re-calibrated any time new firmware is installed and anytime the Cellular Adapter is removed and reinstalled. See [“Power Measurements” on page 130](#) See also [“To Recalibrate Relative TX Power” on page 287](#).

To Access the DCCH Call Processing Screens via HP-IB

Use the same command to access the CALL CONTROL screen that you would use for AMPS operation: **DISP ACNT**. Then set the system type to DCCH with the **CALLP:CSYS `DCCH** command.

To Display Measurements on the Call Control Screen

The **Connect** annunciator must be “lit” before measurements can be displayed on the CALL CONTROL screen. To make measurements without having a connected call, such as when operating the mobile in its test mode, go to the DIGITAL MEASUREMENTS screen.

Recalibrate After Changing Cellular Adapters

Any time a Cellular Adapter is used with a different Test Set, the PER_CALD calibration routine must be run to calibrate the two instruments. See [“I/Q Modulator and Relative TX Power Calibration” on page 287](#)

Restoring Temporary Calibration Factors After a Firmware Upgrade

If you requested and received a firmware upgrade for your Test Set, you need to restore the calibration factors used for three functions: TX Power measurements, DC Current measurements, and DC FM offset.

To re-establish the TX Power zero point:

1. Disconnect any signals to the RF IN/OUT port on the Test Set.
2. Press the TX key to access the TX TEST screen.
3. Select the **TX Pwr Zero** field.

To re-establish the DC Current zero point:

1. Disconnect any cables to the DC CURRENT MEASUREMENT connections on the Test Set's rear panel.
2. Select **AF ANL** from the To Screen menu to go to the AF ANALYZER screen.
3. Select the **DC Current [Zero]** field.

To re-establish the DCFM zero point:

1. Disconnect any signals to the Test Set's front-panel AUDIO IN and RF IN/OUT ports.
2. Select **RF GEN** from the To Screen menu to go to the RF GENERATOR screen.
3. Set the **AFGen1 To** field to **FM, 0.00** kHz.
4. Select the **FM Coupling** field to **DC**.
5. Select the **DC FM Zero** field.

Vocoder Selection

The Test Set does not contain its own vocoder, but it does support the use of the VSELP and ACELP vocoders in mobiles. If you have a Test Set with a firmware revision in the range of B.04.01 to B.05.00, you can only access the ACELP selection using remote (HP-IB) operation (**CALLP:DCCH:VOC 'ACELP'**). For firmware version B.05.01 and above, you can select both vocoders manually or via HP-IB.

Setting the RF Generator Frequency and Amplitude Outside of the Call Control Screens When Using a PCS Interface

It is possible to use other screens and control fields outside of the Call Control screens when using the Cellular Adapter with a PCS Interface. When operating on another screen (such as the DUPLEX TEST screen) you should reset the **Amplitude** after changing the **RF Gen Freq** to ensure that the RF amplitude is accurate. This operation is not required when setting the channel number on the Call Control screens.

Remote Operation Considerations and Recommendations

The following items discuss operation under HP-IB control. For much more information on programming in the Call Processing Subsystem, refer to the *HP 8920B Programmer's Guide* HP P/N 08920-90222.

Loopback BER

When making loopback BER measurements on the DIGITAL MEASUREMENTS screen, configure the DTC settings on the CALL CONTROL screen prior to switching to the DIGITAL MEASUREMENTS screen.

To Prevent Problems When Changing the System Type

Changing the **System Type** field (on the Call Control screen) from **AMPS** to **DCCH**, and then immediately changing the **Cntrl Chan** settings, can cause the Test Set to experience a non-recoverable firmware error (a “fatal” error requiring you to turn the Test Set off and back on). This can be eliminated by either querying the call processing status registers until the **Active** annunciator is lit (recommended method) or by inserting a wait statement (of about 3 seconds) in your program after the **System Type** is changed.

Temperature Compensation

The CALL CONTROL or DCCH CALL CONFIGURE II must be displayed before performing the temperature compensation using the **CPR:DCCH:ZPOW** command.

Handoffs

After establishing a call on a DTC, wait at least 1 second before handing the call off to another channel. This helps eliminate the error “**Handoff message not acknowledged by mobile**”.

Releasing a Call

After establishing a call on a DTC, wait at least 1 second before releasing the call. This helps eliminate the error “**Release acknowledgment not acknowledged by mobile**”.

Going from the Data Display to the Measurement Display Mode

When changing the **Display** field from **Data** to **Meas**, you can get the error “**Query UNTERMINATED**” if you query a measurement too soon. A wait of .2 seconds after changing the Display setting should eliminate this problem.

Changing from ANALOG MEAS Screen to CALL CONTROL Screen Measurements

When going from the ANALOG MEAS screen to the CALL CONTROL screen to make a MAHO or Adjacent Channel Power measurement, you should wait about .4 seconds (at cellular band frequencies) or .6 seconds (at PCS frequencies) before querying the measurement.

Zeroing the Power Meter With a PCS Interface

The trigger mode retrigger must be set to “Repetitive” when zeroing the power meter in the PCS Interface (**TRIG:MODE:RETR REP**).

Remember to set the **System Type** on the CALL CONTROL screen to **DCCH** and set the **PCS Mode** field on the CONFIGURE screen to **On** before attempting to zero the meter using the **CPR:DCCH:ZPOW** command.

Triggering to Prevent Non-recoverable Firmware Errors

Occasionally you may encounter non-recoverable firmware errors resulting from timing conflicts between your program and the Cellular Adapter. These conflicts are often caused by using immediate trigger commands that do not allow the Cellular Adapter enough time to complete a measurement before being queried. To help prevent this problem, use the default continuous trigger state whenever possible.

Reducing Wait Statements in Your Program

Wait statements are typically used to allow the Test System to finish the last requested operation before sending another command. A much more efficient programming method is to use the Call Processing Status Registers to control program execution. These registers monitor various call processing operations and indicate when a condition exists; such as when a mobile has successfully answered a page and the Test Set is in the Connect state. Using these registers, you can write routines that cause the program to wait until a certain register indicates an operating conditions exists, instead of entering some specific time period in seconds. Refer to the *HP 8920B Programmer's Guide* for more information on using the Call Processing Status Registers.

Problems With or Without a PCS Interface Present

This section deals with Test Systems that do not include a PCS Interface.

Mobile will not camp on a Control Channel.

- Verify that you have correctly connected the mobile to the Test System. See [“Connecting a Mobile” on page 38](#).
- Verify that you have set the **System Type** field (on the CALL CONTROL screen) to **DCCH**.
- Verify that you have set the **Cntrl Chan** settings to match the capabilities of your mobile.
- Verify that you have set the **SID** (System Identification number) to match the programming of your mobile.
- Verify that the **Amplitude** field is set to a level that provides a Control Channel with great enough amplitude for the mobile to camp on. This level may have to be adjusted higher than expected if another strong Control Channel signal is being generated at a different frequency near the mobile under test.
- Press the DUPLEX key to access the DUPLEX TEST screen. Verify that the **Input Port** field is set to **RF In**, and that the **Output Port** field is set to **RF OUT**. These settings assume you are connecting the mobile’s antenna port directly to the RF IN/OUT port of the mobile. If the mobile’s receive and transmit connections have been separated for testing, set these fields according to the configuration you are using.

Message “DTC msg not acknowledged by mobile” occurs during attempt to page mobile.

(This assumes the mobile does register successfully.)

- Verify that you have selected the correct vocoder setting for your mobile in the **Voc:** field (on the CALL CONTROL screen).
- Verify that the **MS ID** field is set to **Phone Num** and that the correct phone number for the mobile is entered.

Mobile successfully answers page but immediately drops the call.

- The **Traffic Chan Assignment** settings are not compatible with your mobile. Be sure to set the **Type:**, **Band:**, and **Chan:** fields for the traffic channel you want the mobile to go to when paged.

The message “Squelch Interrupt Overfull. Press MEAS RESET” is displayed.

This message occurs because the Test Set’s squelch threshold is continually being crossed by the digital signals from the mobile, overflowing an internal memory buffer. This situation does not affect measurement ability or accuracy, and should be ignored.

The message “Symbol clock is weak: accuracy is degraded” is displayed.

The DIGITAL MEASUREMENTS screen expects to see a symbol clock to be able to make measurements on a DTC. This message occurs when accessing this screen while the mobile is on an AVC; a situation where a symbol clock is not normally present.

If this message is displayed while measuring a DTC, increase the signal level of the mobile until this message is no longer displayed.

Problems Specific to Using a PCS Interface

This section deals with problems specific to using a PCS Interface.

Mobile will not camp on a Control Channel.

- Verify that you have correctly connected the PCS interface to the Test Set. See [“PCS Interface Connections” on page 288](#).
- Verify that you have correctly connected the mobile to the Test System. See [“Connecting a Mobile” on page 38](#).
- Verify that the PCS Interface is turned on (the POWER LED is on).
- Verify that you have set the **PCS Mode** field (on the CONFIGURE screen) to **On**.
- Verify that you have set the **MS Capab** field (on the DCCH CALL CONFIGURE II screen) to match the type of mobile you are using.
 - If the mobile is capable of operating in the US PCS band, set this field to **US PCS** (even if you are testing it at Cellular band frequencies).
 - If the mobile is not PCS-capable, set this field to **Cellular**.
- Press the DUPLEX key to access the DUPLEX TEST screen. Verify that the **Input Port** field is set to **Ant**, and that the **Output Port** field is set to **Dupl**. These settings are needed to correctly work with the PCS Interface.

Message “Selection not supported in PCS mode” occurs.

This message is displayed when trying to select a **System Type** on the Call Control screen that is not supported when using the PCS Interface, such as TACS or J-TACS.

The PCS Interface is on but the PCS Mode field does not appear on the CONFIGURE screen.

The PCS Interface must be connected properly to the Test Set, and be turned on before the Test Set, for the Test Set to control it.

1. Verify that the serial cable is connected between Test Set’s Serial Port and the PCS Interface’s Serial Port.
2. Verify that the HP-IB/SER switch on the PCS Interface is set to the SER position.
3. Turn the Test Set and the PCS Interface off.
4. Turn the PCS Interface on and wait until it beeps twice. The two beeps indicate that the PCS Interface is set to serial control.
5. Turn the Test Set on.
6. Press SHIFT, DUPLEX(CONFIG) to access the CONFIGURATION screen.
7. Select the PCS Mode field. The field will remain highlighted for several seconds as the PCS Interface is switched into the RF path of the Test System. When the field is no longer highlighted, it will indicate that the PCS Mode is **On**.

Messages

The messages included below are those specific to the Cellular Adapter. For Test Set messages refer to the *HP 8920 Series Test Set User's Guide*.

Alert attempted while not in Maintenance or Connect state.

Amb Lite Communication FAILED.

Amb Lite Communication OK.

Attempt to start DTC Loopback while not Active.

Attempt to start DTC Loopback with an Analog Voice Channel.

Call Processing Reset to Control Channel.

Cannot zero the power meter while in connected state.

Convergence error: readings may be invalid.

The DCCH has been aborted.

The DTC has been aborted.

FACCH/SACCH Buffer overflow

Handoff attempted while not in Connect state.

IPC Port Error.

Measurements available only in Connect State or Dig Meas Screen

The mobile didn't acknowledge the change power order.

Mobile failed to respond to the Page message.

Mobile failed to send the Registration message.

No Reverse DTC is being detected, loss of Traffic Channel.

Order attempted while not in Connect state.

Order attempted while not on Control Channel.

Origination attempted while not in Active state.

Origination in progress.

Overdriven: accuracy may be degraded.

Page attempted while not in Active state.

Registration attempted while not in Active state.

The release acknowledgment was not received from mobile.

Release attempted while not in Connect state.

RF Power Loss indicates loss of Voice Channel.

Signal weak: accuracy may be degraded.

Symbol clk weak (all zeros?): accuracy degraded.

Sync error not found: accuracy may be degraded.

Sync word timing error: readings may be invalid.

Time-out occurred while attempting to access Mobile.

Time-out occurred while attempting to alert Mobile.

Time-out occurred while attempting to page Mobile.

Time-out occurred while attempting to register Mobile.

Time-out occurred while in Maintenance state.

Time-out occurred while waiting for answer from Mobile.

TIA/EIA-136 Basics

This chapter briefly describes the TIA/EIA-136 system, and its Digital Control Channel (DCCH).

What is TIA/EIA-136?

TIA/EIA-136 is a mobile communications system standard which extends the functions of the dual-mode system standard TIA/EIA-627. TIA/EIA-627 is also known as NADC/TDMA (North American Dual Mode Cellular/Time Division Multiple Access).

NADC/TDMA is a dual mode, full duplex cellular communications system in which each voice channel can be defined by both a frequency and a time slot. In earlier cellular communication systems the voice channel was defined only by a frequency. By sharing one transmission frequency, more calls can be transmitted. The dual mode system uses a digital traffic channel (DTC) or an analog voice channel (AVC). The dual mode system uses only an Analog Control channel to control transmissions on the voice and traffic channels. TIA/EIA-136 has the DTC, AVC, ACC, and adds a Digital Control Channel (DCCH).

TIA/EIA-136 expands the capability of the TIA/EIA-627 system to include:

- Sleep mode for decreased battery usage during non-talking time
- Public, private, and semiprivate cells such as picocells in office buildings and personal base stations
- Short Message Service (SMS) for both point-to-point and broadcast information
- Greatly improved security (using DCCH and authentication)
- Improved voice quality

Basic Features of TIA/EIA-136

These features apply to the TIA/EIA-136 system as specified in the TIA/EIA system standards.

-Feature	Description
Frequency Range	Reverse (mobile transmits): 824 to 849 MHz Forward (base transmits): 869 to 894 MHz
1900 MHz hyperband recommended Frequency Range	Reverse: 1850 to 1910 MHz Forward: 1930 to 1990 MHz
Channel spacing	30 kHz
Time slots per channel	6
Users per voice/traffic channel	3 (full rate) (double and triple rates are optional)
Modulation	Digital: $\pi/4$ DQPSK, Nyquist filter factor = 0.35 Analog: FM
Data structure	TDMA
Speech coding	VSELP: 7950 bps, ACELP 7400 bps
Modulation data rate	24.3 kilo symbols per second (1 symbol = 2 bits)
TIA/EIA standards	TIA/EIA-136 IS-137 for mobile stations IS-138 for base stations
RX/TX frequency spacing	Cellular: 45 MHz, PCS:80.04 MHz

TIA/EIA-136 transceiver

The Transceiver Control Block

The block diagram for a typical TIA/EIA-136 transceiver (Figure 77 on page 270) is nearly the same as that of an TIA/EIA-627 TDMA transceiver. The primary difference between the two systems is in the control channel. All control channel operations occur in the Transceiver Control Block. This block controls both the control channels and the complete operation of the transceiver. The control block for a TIA/EIA-136 transceiver must be capable of communicating in either analog or digital control channels.

Modulation Methods

$\pi/4$ DQPSK is the modulation method for the digital channels. Frequency Modulation (FM) or Frequency Shift Keying (FSK) are the modulation methods used for the analog channels.

FM CIRCUITS CAN OFTEN OCCUR IN A DIGITAL SIGNAL PROCESSOR (DSP)

The FM can occur digitally within a mobile station. In Figure 77 on page 270, the FM path is shown separately. This is done in order to show that TIA/EIA-136 mobiles have both an FM path and a $\pi/4$ DQPSK modulation path.

The Control Channels

TIA/EIA-136 has both digital (DCCH) and analog (ACC) control channels. The ACC controls the analog transmissions and guarantees backwards compatibility with systems such as AMPS and TIA/EIA-627. The DCCH controls the digital transmissions and enables the specialized features of TIA/EIA-136.

A transceiver on an ACC has an Idle mode. During this state, the transceiver waits for messages from the base station, or it can originate a call. A transceiver on a DCCH has a similar state: Camping. The major transactions which can be processed during the Idle and Camping states are listed in the following table.

Table 6 Major Transactions Which Can Be Processed in Idle or Camping Modes

Transactions that can be processed during Idle on an ACC	Transactions that can be processed during Camping on a DCCH
Origination	Origination
Respond to pages	Respond to pages
Registration	Registration
Respond to overhead message	SSD update
Respond to orders	User group call
Switch to a DCCH	Originate a point-to-point teleservice
	Terminate a point-to-point teleservice
	Authentication
	Switch to an ACC

**TIA/EIA-136
 Transceiver Block
 Diagram**

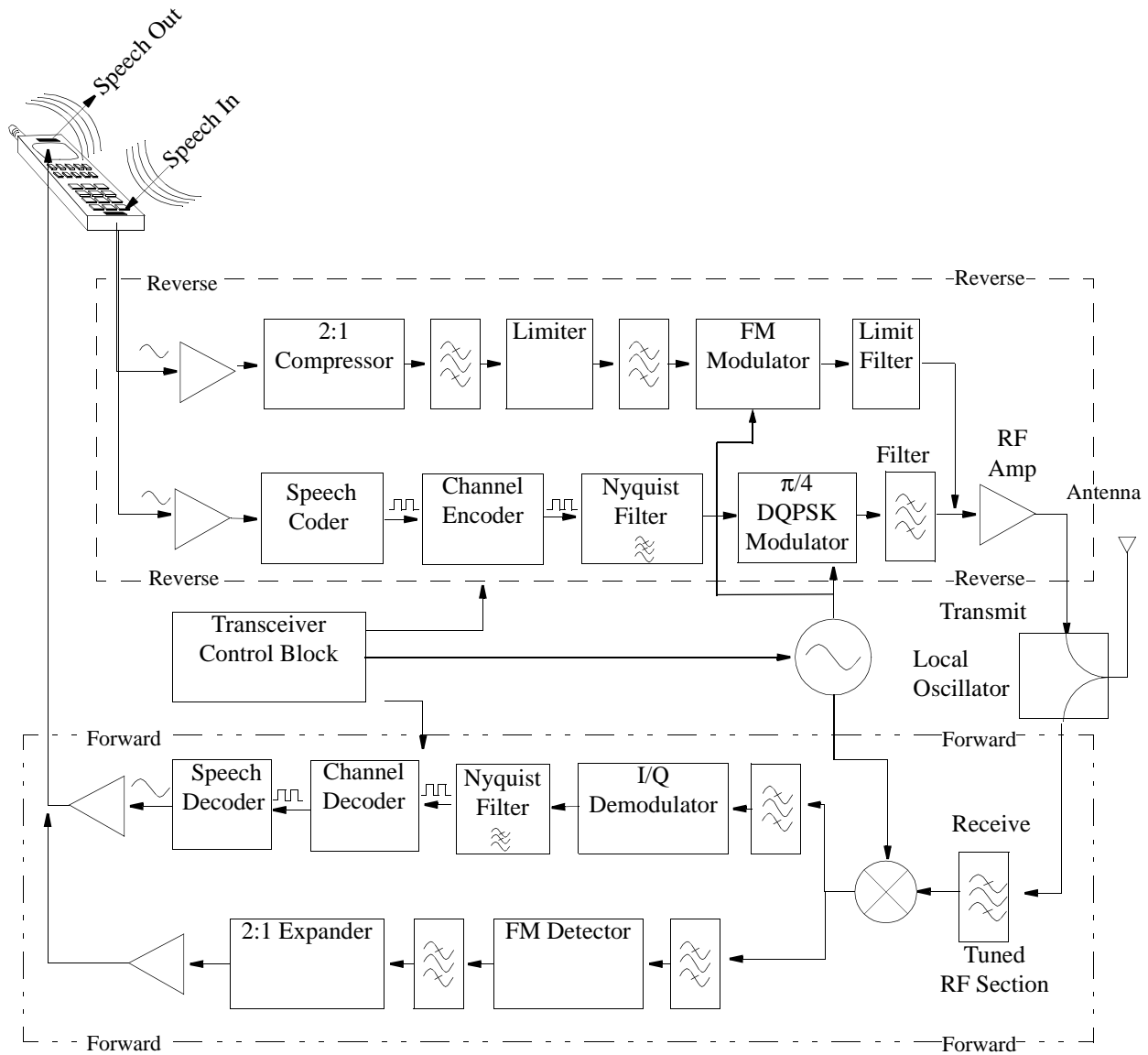

Figure 77 a TIA/EIA-136 Dual Mode Transceiver

Basic Functions of the DCCH in TIA/EIA-136

The process of making a TIA/EIA-136 call is essentially the same as making a TIA/EIA-627 TDMA call. The primary difference comes in the control channel functions.

The following sections describe the functions of the Digital Control Channel (DCCH) used in TIA/EIA-136. Since analog functions have been in use in AMPS and TIA/EIA-627 systems, these should already be familiar to you and will not be discussed here.

Functions used in TIA/EIA-136 systems are listed below.

1. Power On and Initialization
2. DCCH Scanning and Locking
3. Call Origination
4. Call Release
5. Time Alignment and Other Orders
6. Registration and Periodic Registration
7. Paging
8. Handoffs and Mobile Assisted Handoff (MAHO)
9. Short Message Service (SMS)
10. Authentication
11. Non-public System Selection
12. Mobile Assisted Channel Allocation(MACA)
13. Dual Tone Multi-Frequency Signaling (DTMF)

Power On and Initialization

After the mobile powers up, it initializes. It must then determine whether to look for an analog or a Digital Control Channel. Once that decision is made, there are more tasks to be performed before the mobile reaches a state in which a call can be made. The table below identifies these procedures for both the ACC and DCCH.

After initialization, the mobile enters the idle mode and stays there whenever it is not actively involved in messaging or processing a telephone call. Idle mode for a TIA/EIA-136 mobile is called Idle when monitoring the ACCH and Camping for the DCCH.

The basic steps in initialization are described below.

Power On	
Select preferred system (A or B)	
Mobile chooses whether to search for a DCCH or an ACC	
DCCH	ACC
DCCH Scanning and Locking	Start Initialization Task
Select Digital Control Channel	Scan Primary Set of Dedicated Control Channels
Determine Signal Strength Aspects	Update Digital Overhead Information
Determine Service Aspects	Primary Paging Channel Selection
Enter DCCH Camping state	Verify Overhead Channel Information
	Enter Idle state

DCCH Initialization Tasks

DCCH Scanning and Locking

When checking control channels for the strongest one, a mobile may scan all channels. However, in the TIA/EIA-136 system, the DCCHs are scanned in blocks. This is done to shorten the time required to find a control channel.

The entire set of channels for a system is divided into 16 blocks, called probability blocks. Each block is assigned a relative probability for the likelihood of providing DCCH support. Service providers assign these probability blocks.

The mobile station will typically store the prioritized list of probability blocks for its home system. The mobile will search each block's channels in ascending order.

After communication has been established with a service provider, a 'neighbor list' may be provided. This list contains information about the DCCHs that are available in neighboring cells. This list is used by the mobile when searching probability blocks for a new DCCH.

The candidate DCCH is selected in this step.

Determine Signal Strength Aspects:

The mobile must evaluate the candidate DCCH for the following conditions:

- received signal strength is sufficient
- the maximum power of the mobile meets the system's allowed maximum power criteria

Determine Service Aspects:

The mobile must evaluate the candidate DCCH for the following conditions:

- if it is a DCCH allocated to the mobile according to its PAID (Paging Channel Allocation ID)
- if the mobile is barred from using that system
- if the DCCH has the Network Type to which the mobile subscribes

Enter DCCH Camping State:

The DCCH Camping State is analogous to the Analog Control Channel's Idle state. From this state all orders can be processed. Additionally, if the mobile determines it is appropriate to search for a new control channel (either ACC or DCCH), it can return to the Control Channel Scanning and Locking State.

Call Origination

When a user with a mobile tries to call someone, the mobile makes a call origination. A mobile can be using either a Digital or Analog Control Channel, and it can originate a call to use either a DTC or AVC.

When another party makes a call to the mobile, the base sends the page message.

The basic steps in mobile initiated call origination are as follows.

1. Mobile begins in Camping Mode or Idle mode
2. Mobile creates and sends an Origination message
3. Mobile receives a Channel Designation (either DTC or AVC)
4. Mobile invokes Registration Update procedure
5. Mobile tunes to the traffic channel and starts transmitting
6. Mobile enters Conversation Task

There are four types of call originations. These are listed below, and the specific steps for each type are described in [Table 7, "Call Origination Steps," on page 274.](#)

1. Originate from DCCH to DTC
2. Originate from DCCH to AVC
3. Originate from ACC to DTC
4. Originate from ACC to AVC

Table 7 Call Origination Steps

1 Begin In Camping or Idle State	DCCH Camping State		ACC Idle State	
	1 Originate on DTC	2 Originate on AVC	3 Originate on DTC	4 Originate on AVC
2 Create and Send Origination Message	Origination message contains SCM and Service Code		Word A sent, contains SCM and MIN1	
3 Receive Channel Designation	Receive DTC designation	Receive AVC designation	Receive Control Message Word 1 (DVCC)	Receive Control Message Word 1 (SAT)
			Receive Digital Assignment Word	Receive Digital Assignment Word
4 Invoke Registration Update procedure	Invoke Registration Update	Invoke Autonomous Registration Update	Invoke Registration Update	Invoke Autonomous Registration Update
5 Tune to traffic channel and start transmitting	Mobile tunes to DTC, sets transmit and receive rates, time slot	Mobile tunes to voice channel, sets transmitter power level, and begins transmitting SAT	Mobile tunes to DTC, sets transmit and receive rates, time slot	Mobile tunes to voice channel, sets transmitter power level, and begins transmitting SAT
	Transmits either normal or shortened bursts until timing is aligned		Always transmits shortened bursts until timing is aligned	
6 Enter Conversation Task	Begin Conversation		Begin Conversation	

Camping Mode

This is the mode in which the mobile waits for orders, or originates a call. This is analogous to Idle mode in an analog system.

Origination Message

The mobile transmits an Origination Message after confirming that the channel is accessible by monitoring the Overload control. The Origination Message is transmitted on the RACH (Random Access Channel). This message contains information such as that listed below.

- called party number
- whether it is an emergency call or not
- voice mode
- data mode

Channel Designation

This assigns the RF channel of the traffic (or voice) channel. Some information included in this message is listed below.

- traffic channel number
- voice mode (defaults to VSELP voice coder and No Voice privacy)
- DMAC (Digital Mobile Attenuation Code) assigns mobile power level
- Assigned Time Slot (ATS)
- time alignment

Registration Update

The mobile receives and updates the SID (System Identification) and the registration period parameters.

Confirm Initial Traffic Channel

The mobile tunes to the assigned RF channel, sets DVCC, DMAC, time slot assignment, and Base Station Protocol Version status.

Conversation Mode

The user can begin the conversation.

Call Release

During conversation mode, either party can terminate the call. On a mobile, this can be done by either pressing 'END' or by merely turning power off. When the mobile user terminates the call, the base station smoothly disconnects from the mobile.

Mobile releases call

1. Mobile sends a release message
2. Mobile terminates Conversation mode
3. Base station sends acknowledge message
4. Mobile enters Serving System Determination task

Base releases call

1. Base sends a release message
2. Mobile sends an acknowledge message
3. Mobile terminates Conversation mode
4. Base station sends acknowledge message
5. Mobile enters Serving System Determination task

Time Alignment and Other Orders

There are many features of TIA/EIA-136 that can be used to maintain or update information within the system. Some of these are described below.

- Time Alignment. Once on a DTC, the base station can adjust the time alignment of the mobile's transmissions. This modifies the timing of the data within the mobile's assigned time slot.
- Message Waiting Indicator. The base can notify the mobile and indicate the number of messages that are waiting.
- Calling Number Identification. This is sent from the base to the mobile, indicating the number of the phone which is trying to contact the mobile.
- Distinctive Ring. The base can define the type of sound the mobile produces when it is called. The base can choose medium, high, or low pitch. It can also select the period of the signal. This can be several combinations of long, short, PBX, or PIP (very short).

Registration and Periodic Registration

Registration is the process by which the mobile identifies itself to the base. Periodic registration is a way to remind the base station that the mobile is still in the area. It is used when the mobile wants to conserve battery power.

The basic procedure for registration is described below.

1. Base requests the mobile to register. A parameter on the DCCH broadcast message identifies how the mobile is to respond. Typically the base station tells the mobile station to register and include the Capability Report and the Serial Number messages.
2. Mobile responds with a registration message which corresponds to the required parameters.

Registration for TIA/EIA-136 differs under certain conditions. In these conditions, the mobile replies with a registration that contains a message specific to the condition. Some of the conditions are listed below.

- If the mobile has just powered down, the registration will contain a message with a power down indication. The mobile then enters the Power Down mode (Null mode).
- If the mobile has just powered up, the message contains a Power Up indication.
- If the SID value does not match the mobile's stored SID value, the mobile sends a message with a New System indication.
- If the mobile needs to De-register, then the message sent contains a De-registration indicator.
- If message decryption is enabled, the mobile will send the Message Encryption Mode information with any registration method that is sent.

Periodic Registration

To greatly improve battery conservation, TIA/EIA-136 has the capability to allow the mobile to enter a sleep mode, where the mobile is not listening to any messages sent by the base station. To maintain contact with the base, the mobile must periodically register.

Periodic registration is accomplished by the following steps.

1. Mobile station starts a timer (PER_TMR) based on timing values (REGID and REGID_PER) sent from the base station.
2. The base station continuously updates REGID as a system clock for registrations.
3. Mobile internally updates the value NEXTREG. Its value is also based on REGID and REGID_PER.
4. Mobile, whenever PER_TMR expires, wakes up and looks for a new REGID parameters message. It receives the latest value of REGID.
5. The mobile checks to find out if the value of REGID is greater than the value of NEXTREG.
6. If REGID is greater than NEXTREG, then mobile will start the registration.

Some of the data used in registration are described below.

REG Period (REGPER): the registration periodicity counted in number of 94 superframes. A single count of REGPER is equal to 94 superframes. Values of REGPER are coded from 0 to 511 indicating 94 to 48128 superframes (approximately 1 minute to 8.5 hours).

REGID parameters: contains the REGID and the REGID_PER

REGID: the system clock, ranging from 0 to 1048575.

REGID_PER: the number of superframes over which REGID is incremented. Ranges from 0 to 15 superframes. The value 0 indicates that REGID is not incremented.

A superframe is 16 TDMA frames = about 640 milliseconds.

Paging

Paging occurs primarily for the base to establish a call with the mobile. However, with TIA/EIA-136, there are some other types of information the mobile must respond to.

This is the procedure for responding to a set of specialized page messages.

1. The mobile receives a message indicating a page.
2. The mobile responds with a message appropriate to the type of page sent.
3. The mobile enters the next state appropriate to the type of page.

Some of the pages that the mobile must be able to respond to are listed below.

- Hard Page: the mobile will respond and enter the Waiting for Order state.
- Page with User Group indication: begin User Group procedures.
- Audit Order indicating User Group: if the mobile is part of the proper user group, the mobile will confirm audit order, and re-register if necessary.
- Confirm audit message and re-register if necessary.

Example: Mobile receives a Hard Page which results in call origination

1. The mobile receives a message indicating a Hard Page.
2. The mobile responds with a Page Response message with a Service Code that indicates the desired service. Service Code indicates speech type (analog, digital, or both), fax, or data.
3. The mobile enters the Waiting for Order state.
4. Base station sends a DTC Designation, and the call establishment continues.

Handoffs and Mobile Assisted Handoff (MAHO)

There are several types of handoffs possible within TIA/EIA-136. These are listed below.

- DTC to DTC
- DTC to AVC
- AVC to DTC
- AVC to AVC

Basic steps in all handoffs

1. Start in Conversation task
2. Base station sends a handoff message
3. Mobile acknowledges
4. Mobile tunes to new channel and starts transmitting
5. Timing is aligned
6. End Handoff by re-entering Conversation mode

Table 8

Handoff Direction	DTC to DTC	DTC to AVC	AVC to DTC	AVC to AVC
Start	Start in Conversation mode			
Send Handoff message(s)	Contains new channel, timeslot, DVCC	Contains new channel	Word 1: message type, DVCC	Word 1: message type, AVC
			Word 2: new channel, DMAC	Word 2: new channel, DMAC
Acknowledge	Acknowledge handoff message	Acknowledge handoff message	Send ST for 50 msec.	Send ST for 50 msec.
Transmit	Normal or shortened bursts	SAT	Shortened bursts	SAT
Time alignment	Typically set to Standard Offset Reference (SOR)		Typically set to Standard Offset Reference (SOR)	
End Handoff	Enter Conversation mode			

Mobile Assisted Handoff (MAHO)

MAHO is actually a set of measurements, not a handoff. The base station requires the mobile to provide RF channel signal quality information to its serving base station. The base can then choose a specific channel for the handoff. If the mobile provides information on the present RF channel, it sends RSSI and BER information. If the mobile provides information on any other channel, it sends only the RSSI information.

Procedure for a Mobile Assisted Handoff

1. Start in Conversation task
2. Mobile station receives and acknowledges a Measurements message. This message indicates the channels which the mobile is required to measure.
3. Mobile reports measurements back to base station.
4. Base orders handoff.
5. Handoff proceeds according to its type (DTC to DTC or DTC to AVC).

***MAHO
MEASUREMENTS DO
NOT HAVE TO STOP
BEFORE HANDOFF***

While the mobile is reporting measurements to the base, the base can choose a channel to handoff to. It is not necessary that the mobile stop measurements before this handoff occurs. The base can order the mobile to stop measurements at a later time.

Short Message Service (SMS)

Short Message Service (SMS) is a service available on the DTC and the DCCH. It allows the mobile and base to exchange short messages, typically concerning the operation of the cellular system.

The SMS can be initiated by either the mobile user or the base station. The base station either transmits a message from another user, or sends a message to control the features of the SMS itself.

The procedure for SMS consists of sending an SMS message, then receiving an acknowledgment. The acknowledgment consists of a Delivery Ack, if the message has been delivered, or a Manual Ack, if the user has responded to the message.

Authentication

Authentication is the same for both the ACC and the DCCH. It consists of the base and mobile stations exchanging data. Before the mobile may access the system, this data is verified.

Unique Challenge-Response Procedure

This is the basic procedure of Authentication. The procedure is described below.

1. Base generates a 24-bit pattern called RANDU.
2. Base sends RANDU to the mobile in the Unique Challenge Order message.
3. Mobile receives RANDU.
4. Mobile calculates AUTHU using the RANDU, MIN1, MIN2, ESN and SSD-A.
5. Mobile transmits AUTHU to the base.
6. Base calculates its own AUTHU and compares it to the received AUTHU.
7. If the two values of AUTHU are the same, the mobile is accepted into the system.

Data Used in Authentication

Several different information elements are used in authentication. The primary ones are listed below.

- ESN
- MIN
- SSD
- RAND, the random challenge data
- COUNT_{s-p}, the Call History Parameter

ESN: Electronic Serial Number. Permanently stored in the mobile.

MIN: Mobile Identification Number. Consists of two parts, MIN1(24 bits) and MIN2(8 bits).

SSD: Shared Secret Data. A 128-bit pattern, partitioned into two 64-bit patterns, SSD-A and SSD-B. SSD-A is used for Authentication, and SSD-B is used for voice privacy and message confidentiality.

RAND: Random challenge memory. A 32-bit value stored in the mobile.

COUNT_{s-p}: call history parameter. A modulo-64 count stored in the mobile.

SSD Update Procedure

The base can order the mobile to update its Shared Secret Data. This is done to enhance security.

The procedure to update the SSD is listed below.

1. Base sends an SSD Update order containing the RANDSSD.
2. Mobile calculates a value SSD-A_NEW using RANDSSD, ESN, and the A-key.
3. Mobile generates a random number RANDBS and sends it to the base.
4. Mobile calculates AUTHBS using RANDBS and SSD-A_NEW.
5. Base calculates its own SSD-A_NEW.
6. Base calculates its own AUTHBS using RANDBS and SSD-A_NEW.
7. Base sends its AUTHBS to the mobile.
8. Mobile compares its AUTHBS with the one sent from the base.
9. If both AUTHBS values match, the SSD update is successful.
10. Mobile sends a confirmation to the base.

Data required to update SSD is listed below.

1. ESN
2. MIN1
3. RANDSSD: a 56-bit random number sent by the base
4. A-key: a 64-bit number permanently stored in the mobile

Non-public System Selection

Private and residential systems can provide services using the TIA/EIA-136 standard. These systems are distinguished from public TIA/EIA-136 systems by the network type and the system identification number.

The network types are Public, Private, and Residential.

Every system has an SID. In addition to SIDs, private and residential systems also have Private System IDentifications (PSIDs). Residential systems also have Residential System IDentifications (RSIDs).

Mobile Assisted Channel Allocation(MACA)

The mobile can assist the base in selecting control channels by the MACA procedure. This procedure measures and reports signal quality for either the current channel or multiple channels. There are two types of measurements: long term and short term.

Long term measures WER, BER, and paging frame received signal strength. It measures only on the current control channel.

Short term measures short term received signal strength. It can measure up to 16 control channels.

Dual Tone Multi-Frequency Signaling (DTMF)

This is an option built into TIA/EIA-136. This enables testing of the numeric keypad (digits 0-9, and * and #). Each key is identified by two signals. These signals are transmitted together whenever the key is pressed. The keys and their respective frequencies are identified below.

Table 9

Label of Key		Assigned Frequencies (Hz)	
1		697	1209
2	ABC	697	1336
3	DEF	697	1477
4	GHI	770	1209
5	JKL	770	1336
6	MNO	770	1477
7	PRS	852	1209
8	TUV	852	1336
9	WXY	852	1477
*		941	1209
0	OPER	941	1336
#		941	1477

Installing the Cellular Adapter

This chapter shows how the Cellular Adapter is connected to the HP 8920 Test Set. Connections for the PCS Interface are also provided.

Connecting the Cellular Adapter to the HP 8920 Series Test Set

This preliminary Test Set Cellular Adapter will work only with an HP 8920B series Test Set with correct firmware. If you received firmware to upgrade your Test Set, follow the instructions included with the firmware.

See also the *HP 83206A Assembly Level Repair Manual*.

If you need to make the connections, see [Figure 78](#).

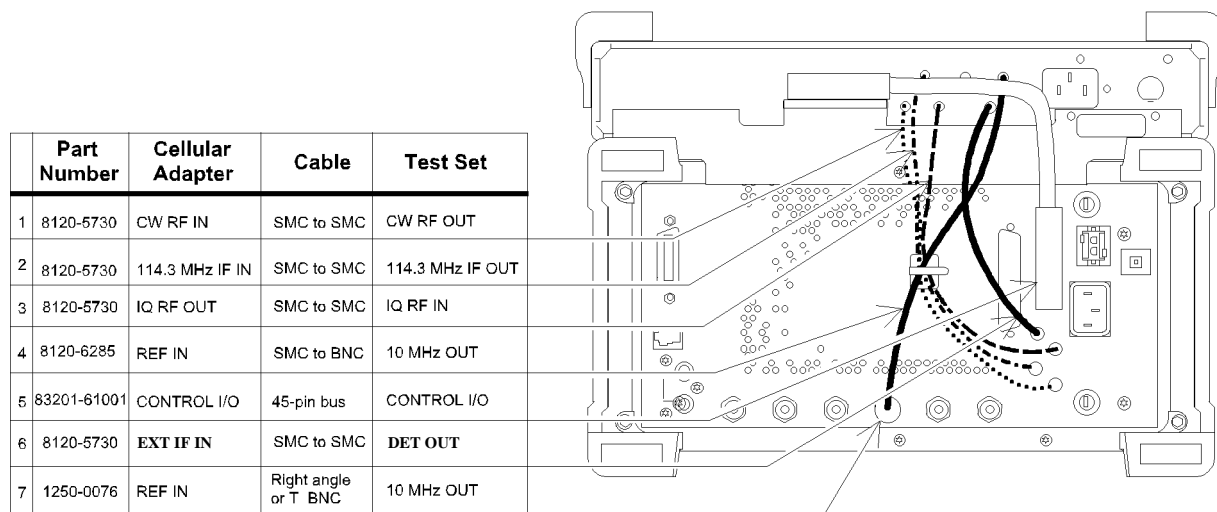

Figure 78 Connection Diagram for the Cellular Adapter

I/Q Modulator and Relative TX Power Calibration

The I/Q Modulator and TX Power calibration routines must be run any time a Cellular Adapter is disconnected and re-attached to a Test Set. TX Power should also be recalibrated any time you suspect the relative TX Power readings are drifting.

Calibration Procedure

1. Press the TEST key to access the TEST (Main Menu) screen.
2. Under **Select Procedure Location:** choose **ROM**.
3. Under **Select Procedure Filename:** choose **PER_CALD**.
4. Press the k1 key to start the calibration program.
5. Follow the directions displayed on the screen.
 - a. Select and run the **I/Q Modulator** routine until it indicates that it has calibrated at all frequencies; this will take several minutes. (Be sure to connect a short cable from the DUPLEX OUT port to the ANT IN port before starting.)
 - b. Select and run the **Tx Power** routine. (Be sure to connect a short cable from the DUPLEX OUT port to the RF IN/OUT port as instructed.)
6. When both calibration routines have been run, turn the Test Set off and back on to enable the new calibration settings.

To Recalibrate Relative TX Power

Repeat the previous procedure, skipping step 5a. Be sure to turn the power off and back on to use the new power calibration settings before making more relative TX Power measurements.

PCS Interface Connections

The PCS Interface is used with the Cellular Adapter and Test Set to test US PCS mobiles (1700 MHz to 1900 MHz). You can also test cellular band (850 MHz) mobiles through the interface. The interface is controlled entirely through a serial cable connection to the Test Set.

The PCS Interface is shipped with all cables needed to connect it to the Test Set. Also shipped with the interface is a memory card containing a System Connectivity program to verify all connections. This software should be loaded and run before using the interface.

The following diagrams are for reference only, and do not show all of the rear-panel connections between the Test Set and the Cellular Adapter (see [Figure 78 on page 286](#)). Complete instructions for connecting the PCS Interface to the Test Set and running the System Connectivity software are included in the PCS Interface's Operating Manual (HP P/N 83236-90100).

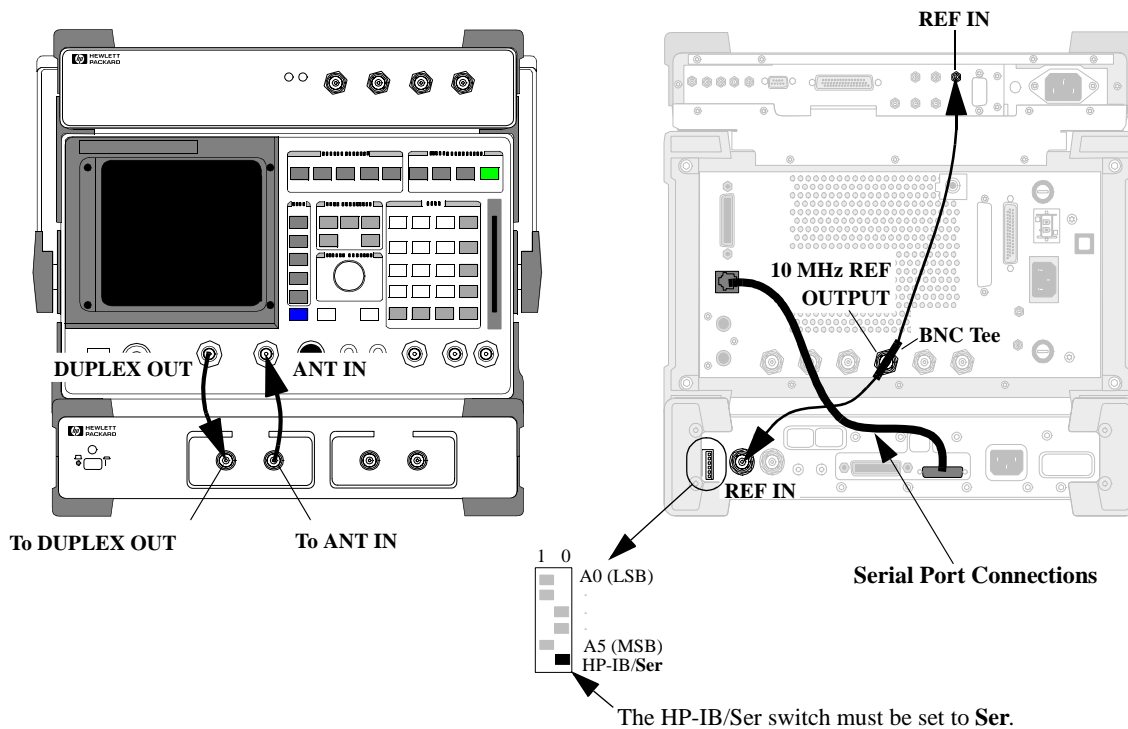
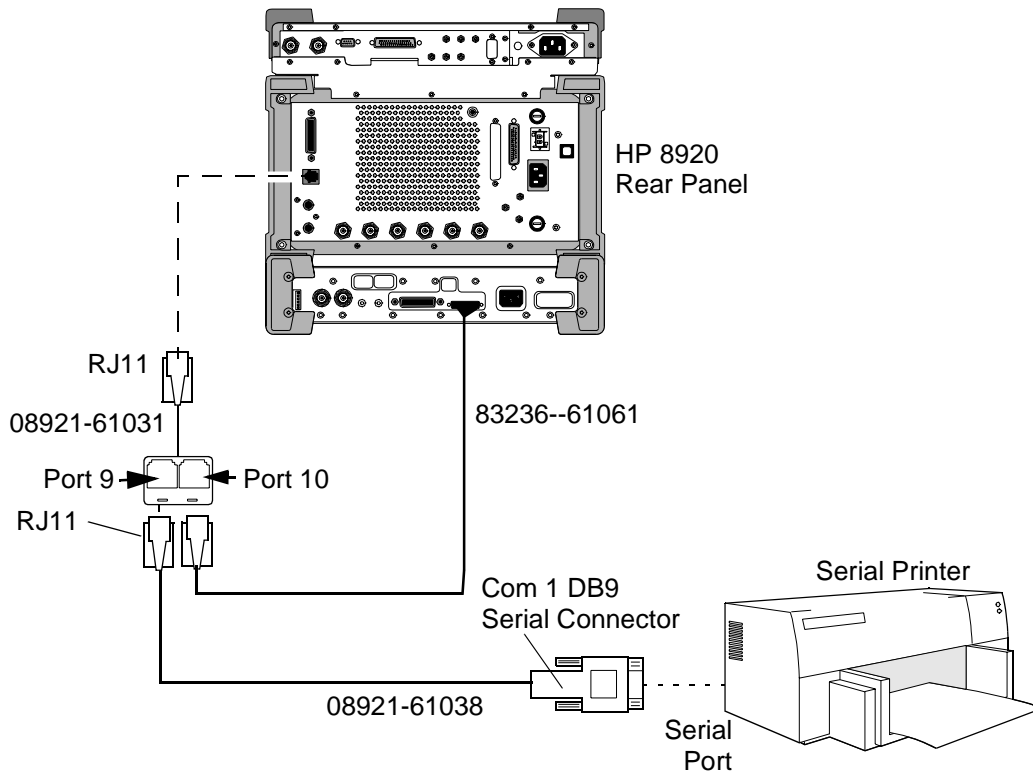

Figure 79

PCS Interface Connections

Connecting a Printer to the Serial Port

The Serial Port of the test set actually contains two separate serial connections; designated Port 9 and Port 10. Port 10 is used to control the PCS Interface. You can connect a serial printer to Port 9 to print screen images. To do this, you must use a specific RJ-11 cable that provides separate RJ-11 jacks for each port.



Glossary

ACC Analog Control Channel. Controls the analog transmissions of a cellular phone system.

Access The Test Set's state in which it is communicating with the transceiver under test.

acknowledgment The process by which one station sends a response message to another station.

ACELP Algebraic code excited linear predictive. An encoding method for voice.

Active The Test Set's state in which it is emulating a base station. In the ACTIVE state, the Test Set is ready to communicate with the transceiver.

adjacent channel power The measured power on some number of higher and lower channels adjacent to the selected channel.

A-key A 64-bit number permanently stored in the mobile, used in authentication.

analog call processing A firmware portion of the Test Set which controls the messages required to setup and maintain a call in the analog portion of a cellular phone system.

analog color code An analog signal transmitted by a base station on an analog voice channel and used to detect capture of a mobile station by an interfering base station or the capture of a base station by an interfering mobile station.

analog control channel A channel used for the transmission of digital control information from a base station to a mobile station or from a mobile station to a base station.

analog parameters Parameters of the analog voice channel.

analog voice channel A channel on which a voice conversation occurs and on which brief digital message may be sent from a base station to a mobile station or from a mobile station to a base station.

ANLG MEAS The screen for analog measurements.

annunciator A screen graphic which identifies the call processing state of the Test Set. When the annunciator is 'lit', that is the state of the Test Set. An example is shown in the following diagram.

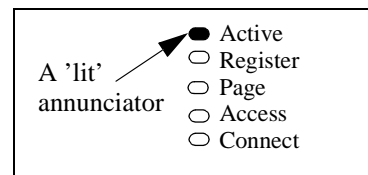

Arm A Test Set command which instructs the Test Set to get ready to measure. The next available data or signal will be measured.

authentication A procedure used by base stations to validate a mobile stations' identity.

Glossary

autonomous registration The process by which the mobile registers without being instructed to do so by the base.

AVC Analog Voice Channel

average power The RMS power.

base station A station in the Domestic Public Cellular Radio Telecommunications Service, other than a mobile station, used for communicating with the mobile.

A fixed-location transceiver in a communications network. The land station in a cellular or PCS network carrying on a radio communication with mobile units.

BER Bit Error Rate. The number of erroneous bits received compared to the total number of bits received during the observation period.

BS Base station.

CALL CNFG The configuration screen for setting up call processing.

CALL CNTL The primary control screen for call processing functions.

call processing The portion of the Test Set that controls cellular call origination, paging, and messaging.

calling number The number that is calling the mobile.

camping The state on a DCCH in which the mobile is available to originate a call or accept orders. Analogous to Idle mode on an ACC.

cellular adapter A self-contained module that attaches to the Test Set. It typically tests a specific system or provides a special function to the Test Set.

channel designation the message in which a voice or traffic channel is assigned.

Choices menu A menu on the display which presents a list of choices.

Connect The Test Set's state in which the Test Set has established a communications link (for example, a call) to the transceiver under test.

control channel A frequency channel which is used to send control messages between the base and the mobile.

COUNT_{s-p} The Call History Parameter, stored in the mobile. Used in authentication.

country code A transmitted code which identifies the country of the mobile. Derived from CCITT Recommendation E.212.

CRC Cyclic Redundancy Check

DAMPS Another name for TDMA following the TIA/EIA-627 specification.

DCCH Digital Control Channel. Controls the digital transmissions of a cellular phone system.

DCCH subsystem The firmware subsystem which controls call processing for DCCH specification TIA/EIA-136.

Glossary

DIG MEAS The screen for digital measurements primarily in the TIA test mode.

digital call processing the portion of the Test Set which control the messages required to setup and maintain a call in the digital portion of a cellular phone system.

Disarm Selecting this command stops the measurement process. See “Arm”.

DMAC Digital Mobile Attenuation Code.

downbanding A special set of frequencies below the normal cellular band.

DQPSK Differential Quadrature Phase Shift Keying. A modulation system in which the signal to be modulated is digitized, and then transmitted on a carrier with a phase corresponding to the digital signal. The actual phase transmitted is relative to the last phase transmitted.

droop The difference between the level of the first symbol and the level of the last symbol captured by the analyzer.

dropped call A call is dropped when the communication between a mobile and the base is abruptly terminated.

DSP Digital Signal Processor. A processor used in the Test Set.

DTC Digital Traffic Channel

DTMF Dual Tone Multiple Frequency signaling. Each key of the numeric keypad on a cellular phone is identified by two signals. These signals are transmitted when the key is pressed.

DUT Device Under Test. The transceiver that is to be tested.

DVCC Digital Verification Color Code. An eight-bit signal sent by the base to the mobile. Used to generate the Coded Digital Verification Color Code (CDVCC), which indicates that the correct data is being decoded.

emulate To imitate. The Test System emulates a base station by performing tasks equivalent to those performed by the actual base station.

ESN Electronic Serial Number.

EVM (EVM1, EVM10) Error Vector Magnitude. The magnitude of the error vector which connects the ideal signal vector to the signal vector measured at the point of detection. EVM is the RMS value, while Peak EVM is the absolute value of the peak EVM measured. EVM10 is the normalized measurement of the first 10 symbols of a burst, averaged over 10 bursts.

FACCH Fast Associated Control Channel. A reverse channel controlling the Reverse Digital Traffic Channel. See also SACCH.

field A selectable location in the screen.

FSK Frequency Shift Keying.

full-rate As described in TDMA systems, the transmission rate at which one call uses only one of the six available slots.

GPB General purpose interface bus. An implementation of IEEE-488.2.

Glossary

half-rate As described in TDMA systems, the transmission rate at which one call uses two of the six available slots.

handoff The process of passing control of a mobile from one base to another.

host firmware Firmware located in the Test Set (the host).

HP-IB See GPIB.

Idle The state on an ACC in which the mobile is available to originate a call or accept orders. Analogous to Camping on a DCCH.

IMSI International Mobile Station Identity. A mobile identification format as specified by CCITT E.212.

initialization The process by which a mobile gets to a state in which it can originate a call or accept orders.

IS-54B This standard has been finalized as TIA/EIA-627.

IS-136 This standard has been finalized as TIA/EIA-136.

Layer 2, Layer 3 Levels of protocol created for the TIA/EIA-136 system.

loopback A state in which incoming data is fed back to the output with little or no modification.

MACA Mobile Assisted Channel Allocation. A procedure in which the network requests mobiles operating on a DCCH to measure and report the signal strength on up to 15 channels specified by the network and reports this information to the network. The network uses the signal quality information reported by the mobile in conjunction with measurements made by the network to decide if the mobile should be handed off to another voice or traffic channel. The mobile measures BER, and RSSI.

magnitude error The rms value of the difference between the expected magnitude of the carrier and the measured magnitude.

MAHO Mobile Assisted HandOff. The process by which a mobile measures and reports signal quality of candidate RF channels to the base. The base then uses this information to select a channel for a handoff.

max abs A measure of the power within the Test Set.

Meas subsystem The firmware subsystem which control measurements.

MS Mobile station.

MSID Mobile Station IDentification.

neighbor list A list of neighboring cells containing information concerning the DCCHs in those cells.

non-public system A system with a restricted group of users. This encompasses private and residential systems.

Glossary

notch filter A filter with a notch characteristic. A certain band (usually narrow) of frequencies is rejected, usually with high suppression.

order A message sent from the base to the mobile which instructs the mobile to perform an action.

origin offset The magnitude of the RF carrier leakage relative to the magnitude of the modulated carrier at the detection point.

origination The process of setting up and initiating a cellular phone call by the mobile. A call originated by the base station is called paging.

Page The Test Set's state in which it is paging the transceiver under test in order to establish communication.

paging The process of setting up and initiating a cellular phone call by the base station. A call begun by the mobile station is called an origination.

PAID Paging Channel Allocation Identification

PCS Personal Communication Services. An evolutionary step of wireless communications which follows cellular communications. Operating in a different frequency band from cellular, it is designed to offer various digital data services as well as voice communications.

peak EVM See "EVM (EVM1, EVM10)" on page 293. The peak value of EVM.

personal base station A base station designed for very small scale use, such as in a home.

periodic registration Periodic registration is used for the mobile transceiver to periodically remind the base station that it is in the cell. See "registration".

phase error The rms value of the difference between the expected phase of the carrier and the measured phase.

$\pi/4$ DQPSK A DQPSK system in which the carrier changes phase by a multiple of $\pi/4$ each time.

picocell A cell of a small size, used in specific areas such as inside buildings.

private system A non-public system set up for use by a private group.

probability block A grouping of control channels which have a certain probability that it will be able to provide DCCH support. The service provider determines which control channels belong to which probability blocks. The mobile stores the order of the probability blocks for its home system.

PSID Public system identification

QPSK Quadrature Phase Shift Keying. A modulation system in which the signal to be modulated is digitized, then transmitted on a carrier with a phase corresponding to the value of the digital signal.

Glossary

RACH Random Access Channel.

RAND Random challenge memory. A value stored in the mobile. Used in authentication.

RDTC Reverse Digital Traffic Channel.

REGID The system clock used for periodic registration.

Register The Test Set's state in which registration occurs.

registration The process by which a mobile identifies itself to a base.

REG_PER A timing value used in periodic registration.

release The process of ending a call between the mobile and another station.

residential system A non-public system set up for use within a home.

reverse FACCH word message The message that is sent from the mobile to the base via the Fast Associated Control Channel.

reverse SACCH word message The message that is sent from the mobile to the base via the Slow Associated Control Channel.

RSID Residential system identification

RSSI Received Signal Strength Indication.

RX Receive

SACCH Slow Associated Control Channel. A reverse channel controlling the Reverse Digital Traffic channel. See also FACCH.

SAT Supervisory Audio Tone.

scanning and locking The process in which the mobile transceiver searches eligible channels, selects one, and locks onto that transmitter's frequency.

SCM Station Class Mark. A message which describes the power class, transmission capability, and bandwidth of the mobile station.

shared secret data Data used in the authentication process.

SID System Identification. A message which must be sent at regular intervals, providing the identification number for the system.

sleep mode The mode in which the mobile is not continually communicating with the base.

slot A time period within a channel dedicated to one transmission.

SMS Short Message Service. Used to transmit short messages from an TIA/EIA-136 base station to a mobile.

SSD Shared Secret Data. Data used in the authentication process.

state The condition that the Test Set is in.

Glossary

subsystem A section of firmware grouped together for a specific task.

sync location The time in number of bit periods from the trigger to the beginning of the first sync word detected.

TDMA Time Division Multiple Access. A type of frequency division in which one frequency is shared by multiple activities sequentially. As a cellular phone system, a TDMA system is defined by both a frequency and a time slot.

test mode A mode in which the mobile allows a traffic channel to become active specifically for the purpose of testing.

Test System The Test equipment, typically a Test Set and a Cellular Adapter, connected together.

TIA/EIA Telecommunications Industry of America/Electronics Industry of America. An organized body of interested parties which creates industry standards for cellular communications and other systems.

TIA/EIA-136 A standard created by the TIA/EIA to define a Time Division Multiple Access (TDMA) cellular phone system. Its major differentiating feature from most other TDMA systems is its Digital Control Channel (DCCH).

TIA/EIA-627 a TIA/EIA specification describing a TDMA system with an ACC, AVC, and DTC.

time alignment The process by which the data transmitted by the mobile is aligned within its time slot. This is necessary in order to prevent bursts of data from multiple

mobiles occupying the same channel from colliding at the base station.

To Screen An area of the Test Set's display in which several features can be selected.

toggle To switch back and forth, typically between two choices.

traffic channel A frequency channel in which voice and other signals are transmitted digitally.

TS Test Set or Test System.

TX Transmit

TX frequency error The difference between the assigned carrier frequency and the measured carrier frequency.

TX power The transmitted power.

user group A group of cellular users, given special capability to communicate with each other.

voice channel A frequency channel in which voice and other signals are transmitted by analog methods.

VSELP Vector Sum Excited Linear Predictive. An encoding method for voice.

Glossary

wake up The process of the mobile returning to its fully active state, after being in sleep mode,

WER Word Error Rate. The number of erroneous words received compared to the total number of words received during the observation period.

zero (power meter) The process by which the Test set measures loss through the Test Set in order to provide the most accurate power measurement.

Symbols

- # Neighbors field
 - DCCH Call Configure screen, [220](#)
- # Systems field
 - DCCH Call Configure screen, [221](#)
- % BIT ERROR field
 - DCCH Call Configure screen, [221](#)

Numerics

- 1 of N field
 - Authentication screen (AVC), [242](#)
- 10 MHz REF OUT, [251](#)
- 10MHz reference, [254](#)
- 1900 MHz testing, [42](#)
- 2x Frame triggering, [232](#)
- 750 us de-emphasis, [234](#)

A

- A_KEY field
 - Authentication screen (AVC), [240](#)
 - Authentication screen (DTC), [237](#)
- ACC
 - definition, [291](#)
 - registration data not displayed, [94](#)
- access
 - definition, [291](#)
- Access annunciator, [209](#)
 - Call Control screen, [209](#)
 - view of, [209](#)
- Access Burst field
 - DCCH Call Configure screen, [221](#)
- access mode
 - test set remains in, [85](#), [90](#), [92](#)
- ACELP
 - definition, [291](#)
- ACELP vocoder, [48](#), [219](#)
- acknowledgement
 - definition, [291](#)
- Active, [209](#)
- active
 - definition, [291](#)
- Active annunciator
 - Call Control screen, [209](#)
 - view of, [209](#)
- Active field
 - Call Control screen, [209](#)
 - view of, [209](#)
- Adjacent Channel Power
 - measuring, [112](#)
- adjacent channel power
 - definition, [291](#)
- AF Anl In field
 - Analog Meas screen, [233](#)
- AF Freq field
 - Analog Meas screen, [234](#)
- AF frequency
 - measurements, [234](#)
- AFGen1
 - selecting, [34](#)
- AFGen1 Freq field
 - Analog Meas screen, [234](#)
- AFGen1 To field
 - Analog Meas screen, [234](#)
- A-key
 - definition, [291](#)

-
- amplitude, 210
 Amplitude field
 Analog Meas screen, 234
 Call Control screen, 210
 Digital Measurement screen, 230
 amplitude triggering, 232
 Amptd Low, Amptd Mid, Amptd Hi triggering, 232
 analog call processing
 definition, 291
 using to make AMPS measurements, 59
 analog color code
 definition, 291
 analog control channel
 definition, 291
 Analog Meas screen
 AF Anl In field, 233
 AF Freq field, 234
 AFGen1 Freq field, 234
 AFGen1 To field, 234
 Amplitude field, 234
 De-Emphasis field, 234
 Detector field, 235
 Filter 1 field, 235
 Filter 2 field, 235
 FM Deviation field, 235
 TX Freq Error measurement, 235
 TX Power measurement, 235
 view of, 233
 ANALOG MEASUREMENT screen, 56
 analog measurements, 56
 analog parameters
 definition, 291
 measuring, 113
 analog voice channel
 definition, 291, 292
 ANLG MEAS
 definition, 291
 ANLG TG IN triggering, 232
 annunciator
 definition, 291
 annunciators
 view of, 67
 arm
 definition, 291
 audio filter, 295
 Authent field
 AUTHENTICATION screen (AVC), 240
 Authentication screen (DTC), 237
 authentication, 281
 AVC, 239
 data used, 281
 definition, 291
 DTC, 236
 procedures, 70
 Authentication screen
 for AVC view of, 239
 for DTC, view of, 236
 AUTHENTICATION screen (AVC)
 Authent field, 240
 Authentication screen (AVC)
 1 of N field, 242
 A_KEY field, 240
 ESN field, 240
 RAND_A field, 241
 RAND_B field, 241
 RAND_U field, 242
 RANDSSD_1 field, 241
 RANDSSD_2 field, 241
 RANDSSD_3 field, 242
 Authentication screen (DTC)
 A_KEY field, 237
 Authent field, 237
 CHECKSUM field, 237
 ESN field, 237
 RAND field, 238
 RAND_U field, 238
 RANDSSD field, 238
 autonomous registration
 definition, 292
 Autotuning with PCS, 44
 AVC
 definition, 292
 AVC authentication, 239
 AVC channel type, 218
 AVC connection ends, 68
 average power
 definition, 292
 measuring, 114
 Average Power measurements, 130
 Avg Power zero, HP-IB operation, 258
- B**
- BAND field (Neighbor List)
 DCCH Call Configure screen, 221
 base station
 active mode, 67
 definition, 292
 emulating, 62
 personal, 295
 BER
 definition, 292
 display, 117, 145
 measuring, 115
 BER, loopback, 257
 bit error rate
 definition, 292
 BS
 definition, 292
-

- C**
- calibration (temperature compensation), 47
 - Calibration factors
 - restoring, 255
 - call
 - originated by mobile, 89
 - CALL CNFG
 - definition, 292
 - CALL CNTL
 - definition, 292
 - CALL CONFIGURE screen, 54
 - Call Configure screen
 - Calling Num, 226
 - call connected indicator, 210
 - CALL CONTROL screen, 53
 - how to access, 37
 - Call Control screen
 - Access annunciator, 209
 - Active annunciator, 209
 - Active field, 209
 - active mode, 67
 - Amplitude field, 210
 - Chan field, 210
 - Cntl Channel field, 211
 - Cntl Order field, 211
 - Connect annunciator, 210
 - Display field, 212
 - DVCC field, 212
 - for DAMPS, view of, 207
 - for DCCH, view of, 207, 208
 - Handoff field, 213
 - how to access, 65
 - MS ID field, 214
 - Order field, 215
 - Page annunciator, 215
 - Page field, 215
 - Pwr Lvl field, 216
 - Register annunciator, 216
 - Register field, 216
 - Release field, 217
 - SAT field, 217
 - SID field, 217
 - Slot field, 218
 - System Type field, 218
 - Traffic Chan Assignment fields, 218
 - Type field, 218
 - VC Order field, 219
 - Voc field, 219
 - Voice Channel Assignment fields, 219
 - call processing
 - analog, 291
 - definition, 292
 - digital, 293
 - handoff, 294
 - origination, 295
 - paging, 295
 - procedures, 61, 243
 - registration, 93, 296
 - setting up, 64
 - tasks, 57
 - unavailable during Meas mode, 107
 - caller ID
 - name, 226, 228
 - name size, 227
 - no name or number, 228
 - number, 226
 - screening, 228
 - send name and number, 228
 - send number only, 228
 - Calling Name field
 - DCCH Call Configure II screen, 226
 - Calling Num
 - Call Configure screen, 226
 - Calling Num field
 - DCCH Call Configure II screen, 226
 - calling number, 79
 - definition, 292
 - camping, 268
 - definition, 292
 - Camping, problems on Cntrl Chan, 259
 - CCITT Recommendation E.212, 80
 - Cellular Adapter
 - front view, 32
 - what it's designed to do, 50
 - cellular adapter
 - definition, 292
 - Chan field
 - Call Control screen, 210
 - channel
 - choosing the correct, 85, 90, 92
 - traffic, 231
 - channel designation, 275
 - definition, 292
 - Channel field (Neighbor List)
 - DCCH Call Configure screen, 221
 - channel number, 210
 - CHECKSUM field
 - Authentication screen (DTC), 237
 - choices menu
 - definition, 292
 - Cntl Channel field
 - Call Control screen, 211
 - Cntl Order field
 - Call Control screen, 211
 - compensation, temperature, 228
 - Configure screen
 - PCS Mode, 44
 - PCS Mode field, 64
 - PCS RF I/O, 44
 - RF Level Offset, 44
 - confirm initial traffic channel, 275
 - confirming registration, 223
 - connect
 - definition, 292
 - Connect annunciator
 - Call Control screen, 210
 - view of, 211
 - connect mode ends, 68
 - connecting
 - do not connect to ANT IN port, 38
 - Test Set to a mobile, 38
 - control channel, 268
 - definition, 292
 - control orders, 88
 - conversation task, 275
 - country code, 80
 - definition, 292
 - Country Code field
 - DCCH Call Configure screen, 221
 - counts-p
 - definition, 292
 - CRC
 - definition, 292
 - current
 - measurements, 234

D

- DAMPS, 50
 - definition, 292
 - how to choose, 50
- DAMPS system type, 218
- data
 - difference between data and measurements, 100
 - how to switch between data and measurements, 101
- data displayed, 101
- DC Current
 - calibrating, 255
- dc level
 - measurements, 234
- DCCH, 50
 - camping state, 273
 - definition, 292
 - how to choose, 50
 - initialization tasks, 272
 - scanning and locking, 272
 - service aspects, 273
 - signal strength, 273
- DCCH Call Configure II screen
 - Calling Name field, 226
 - Calling Num field, 226
 - MS Capab field, 227
 - Name Size field, 227
 - Num Fax field, 227
 - Num SMS field, 227
 - Num Voice field, 227
 - Pres Type field, 228
 - Screen Ind field, 228
 - Temperature field, 228
 - view of, 226
- DCCH Call Configure screen
 - # Neighbors field, 220
 - # Systems field, 221
 - % BIT ERROR field, 221
 - Access Burst field, 221
 - BAND field (Neighbor List), 221
 - Channel field (Neighbor List), 221
 - Country Code field, 221
 - DCCH DVCC field, 222
 - Dig Signal field, 222
 - DTC Burst field, 222
 - Power Meter field, 222
 - PSID/RSID field, 222
 - Publid sys field, 223
 - Reg Conf field, 223
 - RF Path field, 223
 - Sat Tol field, 224
 - SMS Contents field, 224
 - SMS Msg field, 224
 - SMS Size field, 224
 - SMS Type field, 225
 - SOC field, 225
 - view of, 220
- DCCH DVCC field
 - DCCH Call Configure screen, 222
- DCCH screens via HP-IB, 255
- DCCH subsystem
 - definition, 292
- DCCH system type, 218
- DCCH WER
 - measuring, 143
- DCFm Offset
 - calibrating, 255
- De-Emphasis field
 - Analog Meas screen, 234
- Detector field
 - Analog Meas screen, 235
- device under test
 - definition, 293
- DIG MEAS
 - definition, 293
- Dig Meas field
 - Digital Measurement screen, 230
- Dig Signal field
 - DCCH Call Configure screen, 222
- digital call processing
 - definition, 293
- Digital Control Channel
 - see DCCH
- digital control channel
 - definition, 292
- DIGITAL MEASUREMENT screen, 55
- Digital Measurement screen
 - Amplitude field, 230
 - Dig Meas field, 230
 - DVCC field, 230
 - Pwr Gain field, 230
 - Slot field, 231
 - Traffic Chan field, 231
 - Trig Type field, 232
 - view of, 229
- digital measurement screen display, 119
- digital measurements
 - in test mode, 118
- digital quadrature phase-shift keying
 - definition, 293
- digital traffic channel
 - definition, 293
- digital verification color code
 - definition, 293
- digital verification color code (DVCC), 212
- disarm
 - definition, 293
- Display
 - HP-IB error, 257
- Display field
 - Call Control screen, 212
 - view of, 212
- distortion
 - measurements, 234
- DMAC
 - definition, 293
- downbanding, 81
 - definition, 293
- DQPSK
 - definition, 293
- Droop
 - measuring, 120
- droop
 - definition, 293
- dropped call, 111
 - definition, 293
- dropped call indications, 68
- DSP
 - definition, 293
- DTC
 - definition, 293
- DTC authentication, 236
- DTC Burst field
 - DCCH Call Configure screen, 222
- DTC channel type, 218
- DTC Msg error, 259
- DTC not detected, 68
- DTC timeslot, 218
- DTC WER
 - measuring, 143

-
- DTMF, 283
definition, 293
- dual tone multi-frequency signaling, 283
- dual tone multiple frequency
definition, 293
- DUT
definition, 293
- DVCC
choosing the correct, 85, 90, 92
for the DCCH, 222
- DVCC field
Call Control screen, 212
Digital Measurement screen, 230
- DVCC.
See digital verification color code
- E**
- EIA/TIA-136, 32, 218
and TDMA, 266
basic features of, 267
definition, 266, 297
DVCC, slot and channel number, 85,
90, 92
transceiver, 268
- EIA/TIA-136 CALL CONTROL screen
how to access, 37
- EIA/TIA-136 transceiver
block diagram, 270
- EIA/TIA-627, 218
- electronic serial number (ESN), 237, 240
- emulate
definition, 293
- error vector magnitude
definition, 293
- ESN
definition, 293
- ESN field
Authentication screen (AVC), 240
Authentication screen (DTC), 237
- EVM
definition, 293
measuring, 121
- F**
- FACCH, 82, 159
definition, 293
- FACCH/SACCH programming, 159
- fast associated control channel(FACCH),
159
- fax messages waiting, 227
- field
definition, 293
- field descriptions, 205
- filter
selecting the proper notch, 34
- Filter 1 field
Analog Meas screen, 235
- Filter 2 field
Analog Meas screen, 235
- Firmware revisions, 42
- Firmware Upgrade, 42
- flowchart
get ready to test, 33
tasks to test a mobile, 40
- FM Deviation field
Analog Meas screen, 235
- Frame Clk triggering, 232
- frequency error, SAT, 224
- frequency modulation, 268
- frequency shift keying, 268
- FSK
definition, 293
- full-rate
definition, 293

G

- Getting Started, 31
- GPIB
 - definition, 293

H

- half-rate
 - definition, 294
- handoff, 83, 279
 - basic procedure, 279
 - definition, 294
 - display, 84
 - parameters needed, 83
- Handoff field
 - Call Control screen, 213
 - view of, 213
- Handoffs, 255
- Handoffs over HP-IB, 257
- help
 - before you call, 261
- host firmware
 - definition, 294
- HP 83206A
 - about, 32
 - call processing tasks, 57
- HP 8920
 - using the Test Set, 59
- HP Support phone number, 253
- HP-IB
 - accessing DCCH screens, 255
 - displaying screens, 154
- HP-IB command syntax
 - Integer Number Setting, 199
 - Multiple Real Number Setting, 201
 - Real Number Setting, 200
- HP-IB, Avg Pwr zero, 258
- HP-IB, triggering errors, 258
- HP-IB.
 - See GPIB

I

- idle
 - definition, 294
- idle mode, 268
- Immediate triggering, 232
- IMSI
 - definition, 294
- initialization, 271
 - definition, 294
- Initializing the PCS Interface, 44
- Integer Number Setting
 - HP-IB command syntax diagram, 199
- IQ modulation, bypassing or enabling, 223
- IQ RF OUT, 252
- IS-136.
 - See TIA-EIA-136
- IS-137, 55
- IS-54-B.
 - See TIA-EIA-627

L

Layer 2, Layer 3
definition, 294
loopback
definition, 294
Loopback BER, 257
loss of Traffic Channel, 68
loss of voice channel, 68

M

MACA, 283
definition, 294
magnitude error
definition, 294
measuring, 123
MAHO, 279
definition, 294
measuring, 124, 126
procedure, 280
setting up the measurement, 125
Max Abs, 135
max abs
definition, 294
measure subsystem
definition, 294
measurement
changing the display, 107
measurements, 58
AF frequency, 234
changing units, 110
current, 234
dc level, 234
distortion, 234
no call processing during Meas mode,
107
procedures, 99, 243
SNR, 234
TX frequency error, 235
TX power, 235
measurements displayed, 102
measurements screen
display, 106
display of different measurement sets,
103, 104
display of Test mode measurements,
108
displaying, 102
Test mode, 105
message waiting indicator (MWI), 227
meter, power, 222
MIN
MS id, 73
mobile assisted channel allocation, 283
definition, 294
mobile assisted handoff, 279
definition, 294
mobile assisted handoff (MAHO), 124
mobile country code, 80
mobile station identification (MSID), 214
modulation methods, 268
MS
definition, 294
MS Capab
selecting mobile type, 46
MS Capab field
DCCH Call Configure II screen, 227
MSID
definition, 294
MSID field
Call Control screen, 214
Multiple Real Number Setting
HP-IB command syntax diagram, 201
MWI, sending, 211

N

Name Size field
 DCCH Call Configure II screen, 227

neighbor channels, 125

neighbor list
 definition, 294

Neighbor List BAND field
 DCCH Call Configure screen, 221

Neighbor List Channel field
 DCCH Call Configure screen, 221

neighbors, number of, 220

no reverse DTC detected, 68

non-public system
 definition, 294

non-public system selection, 282

Non-recoverable firmware error, 254

Not Avail, 228

Not Scrn (not screened) screening, 228

notch filter
 definition, 295
 selecting, 34

Num Fax field
 DCCH Call Configure II screen, 227

Num SMS field
 DCCH Call Configure II screen, 227

Num Voice field
 DCCH Call Configure II screen, 227

Nwrk Prov (network provided) screening, 228

O

order
 definition, 295

Order field
 Call Control screen, 211, 215

Ordering firmware upgrades, 42

orders, 88

origin offset
 definition, 295
 measuring, 128

origination, 273
 by mobile, 89
 definition, 295
 message, 275

P

p/4 DQPSK
 definition, 295

page
 how to, 91

Page annunciator
 Call Control screen, 215
 view of, 215

Page field
 Call Control screen, 215
 view of, 215

page state
 definition, 295

page the mobile, 215

paging, 278
 definition, 295
 mobile station, 74

paging channel allocation identification
 definition, 295

paging error, 259

PAID
 definition, 295

path loss compensation, 44

PCS
 definition, 295

PCS Interface, 42, 64
 connections, 288

PCS Interface initialization, 44

PCS Interface path loss, 44

PCS Interface, RF IN/OUT port, 44

PCS Mode
 conflict with autotuning, 44
 turning on or off, 64

PCS Mode field
 Configure screen, 64

PCS Operation problems, 261

PCS RF I/O
 path loss, 44

PCS testing, 42, 63

peak EVM
 definition, 295

% BIT ERROR field
 DCCH Call Configure screen, 221

periodic registration, 276, 277
 definition, 295

personal base station
 definition, 295

personal communication services

- definition, 295
 - phase error
 - definition, 295
 - measuring, 129
 - Phone number
 - HP Support, 253
 - phone number
 - MS Id, 73
 - picocell
 - definition, 295
 - power gain, 230
 - power level, 216
 - Power Measurements, 130
 - Power Meter field
 - DCCH Call Configure screen, 222
 - power on and initialization, 271
 - Pres OK, 228
 - Pres Res, 228
 - Pres Type field
 - DCCH Call Configure II screen, 228
 - private system, 222
 - definition, 295
 - probability block
 - definition, 295
 - program example
 - APOW?, 152
 - call processing, 149
 - CCH, 149
 - CME, 154
 - COND?, 149
 - Condition Register, 156
 - CSYS, 149, 154
 - DCON, 154
 - DISP ACNT, 154
 - DMAC?, 151
 - DME, 154
 - DROop?, 152
 - DVCC?, 151
 - FERR?, 152
 - HAND, 152
 - MEAS, 152
 - MTYPe, 152
 - ORD, 151
 - PAGE, 151
 - PNUM?, 150
 - POW?, 151
 - REGister, 150
 - REL, 153
 - SAN, 154
 - SAT, 152
 - SLOT?, 151
 - TPOW?, 152
 - TYPE?, 151
 - VCH, 152
 - VMAC, 152
 - VTYPe, 152
 - ZPOW, 150
 - programming
 - also use HP8920, 148
 - FACCH/SACCH, 159
 - programming commands
 - BLKCount, 163
 - CLEAR, 167
 - CPOVerride, 160
 - FALog, 161
 - FOWord, 165
 - PERiod, 164
 - SALog, 162
 - SEND, 166
 - STOP, 166
 - programming the Cellular Adapter, 147
 - protocol
 - cellular, PCS, or Band 10, 227
 - PSID
 - definition, 295
 - PSID/RSID field
 - DCCH Call Configure screen, 222
 - Public Sys field
 - DCCH Call Configure screen, 223
 - public system, 223
 - public system identification, 295
 - Pwr Gain field
 - Digital Measurement screen, 230
 - Pwr Lvl field
 - Call Control screen, 216
- Q**
- QPSK
 - definition, 295
 - quadrature phase-shift keying
 - definition, 295
 - Query Unterminated, 257

R

RACH
 definition, 296

RAND
 definition, 296

RAND field
 Authentication screen (DTC), 238

RAND_A field
 Authentication screen (AVC), 241

RAND_B field
 Authentication screen (AVC), 241

RAND_U field
 Authentication screen (AVC), 242
 Authentication screen (DTC), 238

RANDSSD field
 Authentication screen (DTC), 238

RANDSSD_1 field
 Authentication screen (AVC), 241

RANDSSD_2 field
 Authentication screen (AVC), 241

RANDSSD_3 field
 Authentication screen (AVC), 242

RDTG
 definition, 296

Real Number Setting
 HP-IB command syntax diagram, 200

received signal strength indication
 definition, 296

REF UNLOCK indicator, 254

reference unlocked, 254

Reg Conf field
 DCCH Call Configure screen, 223

REG_PER
 definition, 296

REGID
 definition, 296

Register annunciator
 Call Control screen, 216
 view of, 216

Register field
 Call Control screen, 216
 view of, 216

register state
 definition, 296

register the mobile, 216

registers
 status, 155

registration, 93, 276

definition, 296
 typical data display, 88, 93

registration update, 275

registration, confirming, 223

release, 276
 base releases, 276
 by mobile, 95, 276
 by Test Set, 96
 definition, 296

release call in progress, 217

Release field
 Call Control screen, 217
 view of, 217

Releasing calls over HP-IB, 257

reset
 restarting the Test Set, 34

residential system, 222
 definition, 296

residential system identification, 296

restoring calibration factors, 255

reverse digital traffic channel (RDTC), 159

reverse FACCH
 definition, 296

reverse SACCH
 definition, 296

RF Analyzer Auto Tuning, 44

RF IN/OUT port, PCS Interface, 44

RF Level Offset
 path loss, 44

RF Path field
 DCCH Call Configure screen, 223

RF power loss, 68

RSID
 definition, 296

RSSI
 definition, 296

RX
 definition, 296

S

SACCH, 82, 159
 definition, 296

SAT field
 Call Control screen, 217

SAT frequency error, 224

Sat Tol field
 DCCH Call Configure screen, 224

SAT.
See supervisory audio tone

Save/Recall settings
 for PCS Interface, 65
 general, 64

saving instrument settings, 64

scanning and locking
 definition, 296

SCM
 definition, 296

screen
 displaying via HP-IB, 154
 mnemonics, 154

Screen Ind field
 DCCH Call Configure II screen, 228

screen reference, 205

screening, caller ID, 228

screens
 how to access, 206

Send MWI, 211

Send SMS, 211

shared secret data
 definition, 296

short message
 automatic contents, 224
 customized contents, 224
 selecting automatic or customized, 225
 sending, 97
 size, 224

short message service, 280
 definition, 296

short messages waiting, 227

shortened DTC burst, 222

SID
 definition, 296

SID field
 Call Control screen, 217

sleep mode
 definition, 296

slot

-
- choosing the correct, [85, 90, 92](#)
 - definition, [296](#)
 - Slot field
 - Call Control screen, [218](#)
 - Digital Measurement screen, [231](#)
 - slot pairings, [231](#)
 - slow associated control channel(SACCH), [159](#)
 - SMS, [280](#)
 - definition, [296](#)
 - SMS Contents field
 - DCCH Call Configure screen, [224](#)
 - SMS messages, [97](#)
 - SMS Msg field
 - DCCH Call Configure screen, [224](#)
 - SMS Size field
 - DCCH Call Configure screen, [224](#)
 - SMS Type field
 - DCCH Call Configure screen, [225](#)
 - SMS, sending, [211](#)
 - SNR
 - measurements, [234](#)
 - SOC field
 - DCCH Call Configure screen, [225](#)
 - Squelch interrupt message, [259](#)
 - SSD
 - definition, [296](#)
 - SSD update, [281](#)
 - state
 - definition, [296](#)
 - status registers, [155](#)
 - subsystem
 - definition, [297](#)
 - supervisory audio tone
 - definition, [296](#)
 - supervisory audio tone (SAT), [217](#)
 - sync location
 - definition, [297](#)
 - measuring, [138](#)
 - system identification
 - definition, [296](#)
 - system identification (SID), [217](#)
 - system operating code, [225](#)
 - system parameter overhead message, [242](#)
 - System Type field
 - Call Control screen, [218](#)
 - systems, number of, [221](#)
- T**
- TDMA, [32](#)
 - definition, [297](#)
 - temperature compensation, [47, 228](#)
 - Temperature compensation, over HP-IB, [257](#)
 - Temperature field
 - DCCH Call Configure II screen, [228](#)
 - test mode, [55](#)
 - definition, [297](#)
 - Test Set
 - connecting to Cellular Adapter, [286](#)
 - test set
 - configuring, [64](#)
 - test system
 - definition, [297](#)
 - TIA test mode measurements, [118](#)
 - connect mode, [118](#)
 - TIA/EIA
 - definition, [297](#)
 - TIA/EIA Test Mode, [55](#)
 - TIA/EIA-627
 - definition, [297](#)
 - time alignment, [276](#)
 - definition, [297](#)
 - timeslot for DTC, [218](#)
 - To Screen
 - definition, [297](#)
 - toggle
 - definition, [297](#)
 - Traffic Chan field
 - Digital Measurement screen, [231](#)
 - traffic channel
 - definition, [297](#)
 - traffic channel assignment, [218](#)
 - Traffic Channel Assignment fields
 - Call Control screen, [218](#)
 - Trig Type field
 - Digital Measurement screen, [232](#)
 - triggering
 - types of, [232](#)
 - Troubleshooting, [253](#)
 - TS
 - definition, [297](#)
 - TX
 - definition, [297](#)
 - TX Freq Error measurement
 - Analog Meas screen, [235](#)
-

TX frequency error
definition, [297](#)
TX power
definition, [297](#)
measuring, [139](#)
TX Power measurement
Analog Meas screen, [235](#)
TX Power measurements, [130](#)
TX Power Zero, [255](#)
Type field
Call Control screen, [218](#)

U
units
changing, [110](#)
user group
definition, [297](#)

V
VC Order field
Call Control screen, [219](#)
vector sum excited linear predictive
definition, [297](#)
Ver&Fail (verify and fail) screening, [228](#)
Ver&Pass (verify and pass) screening,
[228](#)
Voc
ACELP, [48](#)
VSELP, [48](#)
Voc field
Call Control screen, [219](#)
vocoder selection, [48](#)
voice channel
definition, [297](#)
voice channel assignment, [219](#)
Voice Channel Assignment fields
Call Control screen, [219](#)
voice messages waiting, [227](#)
VSELP
definition, [297](#)
VSELP vocoder, [48](#), [219](#)

W

wake up
definition, 298
WER
definition, 298
measuring, 143
word error rate
definition, 298

Z

zero power meter
definition, 298
zero the Average Power meter, 35
zero the RF Power meter
how often, 36
Zeroing the Average Power Meter, 34

